

SMART Podium™ 500 Series

Interactive pen display

User's guide

Extraordinary made simple™

SMART™

Product registration

If you register your SMART product, we'll notify you of new features and software upgrades.

Register online at smarttech.com/registration.

Keep the following information available in case you need to contact SMART Support.

Serial number:

Date of purchase:

FCC warning

This equipment has been tested and found to comply with the limits for a Class A digital device, pursuant to Part 15 of the FCC Rules. These limits are designed to provide reasonable protection against harmful interference when the equipment is operated in a commercial environment. This equipment generates, uses and can radiate radio frequency energy and, if not installed and used in accordance with the manufacturer's instructions, may cause harmful interference to radio communications. Operation of this equipment in a residential area is likely to cause harmful interference in which case the user will be required to correct the interference at his own expense.

Trademark notice

SMART Podium, DVIT, SMART Ink, SMART Notebook, SMART Meeting Pro, SMART GoWire, SMART Board, smarttech, the SMART logo and all SMART taglines are trademarks or registered trademarks of SMART Technologies ULC in the U.S. and/or other countries. Microsoft, Windows, Windows Vista, Excel and PowerPoint are either registered trademarks or trademarks of Microsoft Corporation in the U.S. and/or other countries. Apple, Mac, Mac OS and Finder are trademarks of Apple Inc., registered in the U.S. and other countries. All other third-party product and company names may be trademarks of their respective owners.

Copyright notice

© 2011 SMART Technologies ULC. All rights reserved. No part of this publication may be reproduced, transmitted, transcribed, stored in a retrieval system or translated into any language in any form by any means without the prior written consent of SMART Technologies ULC. Information in this manual is subject to change without notice and does not represent a commitment on the part of SMART.

One or more of the following patents: US6320597; US6326954; US6563491; US6741267; US6803906; US6919880; US6954197; US7151533; US7184030; US7236162; US7619617; US7692625; US7757001; US7932899; USD612396; USD616462; USD617332; USD636784; Other patents pending.

09/2011

Important information

Before you install and use your interactive pen display, read and understand the safety warnings and precautions in this user's guide. These safety warnings and precautions describe the safe and correct operation of your interactive pen display and its accessories, helping you to prevent injuries and equipment damage. Ensure that your interactive pen display is always being used correctly.

Safety warnings and cautions



WARNING

- If the screen is damaged, do not touch any liquid that leaks from it. This liquid is an irritant. If the liquid makes contact with your skin, eyes or mouth, immediately rinse the area with running water for at least 15 minutes. Consult a physician if the liquid makes contact with your eyes or mouth.
- Do not open or disassemble the interactive pen display. You risk electrical shock from the high voltage inside the casing. Opening the casing also voids your warranty.
- Do not let children play with the tethered pen. They may accidentally remove the small tip, which can be a choking hazard.
- If the screen is damaged, be careful of glass fragments that can cut or injure.
- Do not disassemble the stand. You risk physical injury or damage to the stand. Disassembling the stand also voids your warranty.
- Do not operate the stand's incline adjustment levers when the interactive pen display is not mounted on the stand, and do not lift the stand by the adjustment levers. The stand is spring-loaded and without the weight of the interactive pen display, you risk injury or damage to the stand.

 **CAUTION—INTERACTIVE PEN DISPLAY**

- Avoid excessive vibration of the interactive pen display or the tethered pen. Hitting or dropping the interactive pen display can damage the protective plate or other components.
- Do not touch the screen with sharp or metallic objects that could scratch the screen.
- Use only a damp cloth to clean the screen. Do not apply glass cleaner, organic solvents (such as alcohol), or even a mild detergent to the screen. If you use these cleaners, you may damage the screen's finish or the unit's electronics. Using such cleaners also voids the warranty.
- Use only a damp cloth or a cloth dampened with very mild detergent to clean the unit casing or tethered pen. Do not apply paint thinner, benzene, alcohol or other solvents to the casing. If you use these cleaners, you may damage the finish. Using such cleaners also voids the warranty.
- Use only the power adapter that came with the interactive pen display. Other adapters will not work properly, can damage the interactive pen display, and can create a fire hazard. Using a different power adapter also voids the warranty.
- Use only the tethered pen that came with the interactive pen display. Pens or styluses from other products can damage the screen. Also, they will not work with the DVIT™ (Digital Vision Touch) technology.
- Do not use the interactive pen display in a facility control system or any other environment that requires extremely high reliability; the interactive pen display can interfere with or cause other electronic devices to malfunction, or other devices can interfere with or cause the interactive pen display to malfunction. Where use is prohibited, turn off the interactive pen display to prevent the possibility of it interfering with or causing other electronic devices to malfunction. SMART does not accept any liability for direct or consequential damages.
- If you transport the interactive pen display over a distance, we strongly urge you to completely repackage it using the original carton. We designed this packaging with optimal shock and vibration protection. If the original carton is no longer available, pack all components with as much padding as reasonably possible to protect the components from excessive vibration or shock. Do not include loose components in the packaging that could mark, scratch or otherwise damage the screen during the journey.
- Put the interactive pen display down carefully to ensure you do not damage the buttons.
Do not place the interactive pen display on a surface that will mark, scratch or damage the screen.
- Do not place sharp or heavy objects on the interactive pen display.

IMPORTANT INFORMATION

- Do not connect or disconnect the video or power cable if the interactive pen display or your computer is on. If you do, you can damage the screen and/or the computer video card.
- If you move the interactive pen display, adjust the stand to its full upright position, and then use both hands to hold the display unit and the stand separately.
- Do not expose your interactive pen display to high voltage electrostatic discharges or to a build-up of electrostatic charge on the screen. This can cause discoloration and blotches on the screen.
- If the interactive pen display is damaged, turn off the display and disconnect the power adapter in order to prevent further damage or personal injury.

CAUTION—TETHERED PEN

- The tethered pen is a sealed unit that contains electronics but no batteries. If you attempt to open the tethered pen, you will damage these electronics. This makes the tethered pen unusable and voids the warranty.
- Do not touch the screen with any instrument other than the supplied tethered pen, because other instruments may damage the screen.
- Do not apply excessive pressure that can shorten the life of the tethered pen.
- Do not immerse the tethered pen in water.

CAUTION—ENVIRONMENT

- Avoid setting up and using the interactive pen display in an area with excessive levels of dust, humidity and smoke or where it is exposed to direct sunlight, severe temperature changes, heat from other appliances, water or any other liquid. Operate the interactive pen display within a temperature range of 41°F and 95°F (5°C to 35°C) and a humidity range of 20% to 80% (non-condensing). However, you can store the interactive pen display within a temperature range of 14°F to 140°F (-10°C to 60°C) and a humidity range of 20% to 90% (non-condensing).
- Do not modify the power cable. Handle it carefully and avoid bending it excessively. Do not place the power cable in an area where it is likely to be stepped on or pinched by items placed on or against it. If you must run a cable over the floor, lay it in a flat, straight line, and secure it to the floor with tape or a cable management strip of contrasting color.
- The interactive pen display comes with a three-prong, grounding-type power plug designed to fit into a grounding-type power outlet. If you cannot insert the plug into a power outlet, contact an electrician to replace the power outlet. Do not modify the power plug.

IMPORTANT INFORMATION

- Place the interactive pen display in a location where users will have clear and direct access to the main power plug, because they must be able to disconnect the unit at all times. Always disconnect the interactive pen display before you install any devices or perform any maintenance.
- If possible, disconnect the interactive pen display before any thunderstorms. However, do not touch the unit or the unit's power plug during a thunderstorm, because there is a risk of electrical shock.
- Disconnect the interactive pen display if you will not use it for an extended period.
- If the interactive pen display requires replacement parts, use parts that are specified by SMART Technologies.
- Do not expose the interactive pen display to rain or moisture.

Contents

Important information	i
Safety warnings and cautions.....	i
Chapter 1: About your SMART Podium interactive pen display	1
Your SMART Podium interactive pen display features.....	2
Feature highlights.....	3
Your SMART Podium interactive pen display.....	5
Illuminated buttons.....	7
Control panel.....	8
Connection panel.....	9
Chapter 2: Installing your SMART Podium interactive pen display	11
System requirements.....	11
Installing your interactive pen display.....	13
Setting up your interactive pen display.....	13
Orienting your SMART Podium interactive pen display.....	16
Integrating other devices.....	18
Chapter 3: Installing SMART software	21
Installing SMART Notebook software.....	21
Installing SMART Meeting Pro software.....	22
Chapter 4: Using your SMART Podium interactive pen display	25
Turning your interactive pen display on and off.....	26
Using the tethered pen.....	26
Writing or drawing digital ink.....	28
Erasing digital ink.....	28
Changing eraser settings.....	29
Manipulating objects with the tethered pen.....	29
Entering text on the interactive pen display.....	30
Using the illuminated buttons.....	31
Working with Ink Aware applications.....	31
Working with non-Aware applications.....	33
Using a SMART GoWire auto-launch cable.....	36
Chapter 5: Maintaining your SMART Podium interactive pen display	39
Cleaning the screen.....	39
Cleaning the camera windows and reflective tape.....	40
Maintaining ventilation.....	41

CONTENTS

Preventing condensation.....	41
Chapter 6: Troubleshooting your SMART Podium interactive pen display.....	43
Checking the power on your interactive pen display.....	44
Power button indicator issues.....	44
Checking the status on your interactive pen display.....	46
Status indicator issues.....	47
Tethered pen issues.....	47
Image issues.....	48
Control and writing issues.....	51
Mac-specific issues.....	52
Appendix A: Adjusting video settings with the on-screen display (OSD) menu.....	55
Changing settings in the OSD menu.....	55
OSD menu settings.....	56
Appendix B: Hardware environmental compliance.....	59
Waste Electrical and Electronic Equipment regulations (WEEE directive).....	59
Restriction of Certain Hazardous Substances (RoHS directive).....	59
Packaging.....	59
Covered electronic devices.....	60
China's Electronic Information Products regulations.....	60

Chapter 1

About your SMART Podium™ interactive pen display

Your SMART Podium interactive pen display features.....	2
Feature highlights.....	3
Software.....	3
Tethered pen and magnetic pen holder.....	3
SMART Ink.....	3
Illuminated buttons.....	3
Smooth Tilt Stand.....	3
Interactive surface.....	4
Power.....	4
Power saving.....	4
DViT technology.....	4
Durable surface.....	4
Cables.....	4
Security.....	4
USB disable.....	5
HDCP.....	5
Optional accessories.....	5
Your SMART Podium interactive pen display.....	5
Illuminated buttons.....	7
Control panel.....	8
Connection panel.....	9

This chapter describes the features of your SMART Podium 500 series interactive pen display and provides information about product parts and accessories.

Your SMART Podium interactive pen display features

Your SMART Podium 500 series interactive pen display features SMART's proprietary DViT technology on an LCD screen. DViT technology enables you to select, write and erase on the interactive pen display surface. It also enables you to do everything you can do at your computer—open and close applications, conference with others, create new documents or edit existing ones, visit websites, play and manipulate video clips and more—just by touching the interactive pen display surface with the tethered pen. In addition to the familiar features of other interactive pen displays, your SMART Podium 500 series interactive pen display includes illuminated buttons, a magnetic pen holder, a Smooth Tilt Stand and HDCP compliancy. Your interactive pen display works with your computer and SMART Product Drivers to provide a reliable interactive experience with the content from your computer.

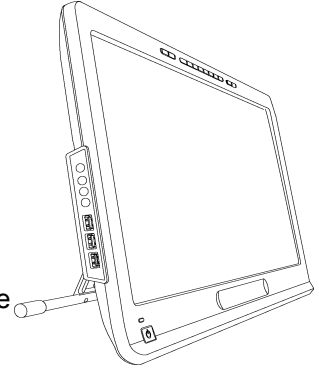

You can also interact with content from additional devices, such as a document camera, that you can connect using the USB receptacles. By connecting your interactive pen display to a projector or a second display you can visually share your interactive experience with others, all while facing the audience. As others view your interactions with your digital materials, you can write confidently and smoothly with SMART Ink™. You can save your work directly into commonly used software applications, such as Microsoft® Office and AutoCAD® software or into the SMART software applications that are included with your interactive pen display.

The following SMART Podium 500 series interactive pen display models are available:

Model	Dimensions	Resolution
SMART Podium 518 interactive pen display	18 1/2" (47 cm) diagonal	1366 × 768
SMART Podium 524 interactive pen display	24" (61 cm) diagonal	1920 × 1080

CHAPTER 1

About your SMART Podium interactive pen display

Feature highlights

Refer to the following for more feature highlights.

Software

Your SMART Podium 500 series interactive pen display includes either SMART Notebook™ collaborative learning software or SMART Meeting Pro™ software. To use all the features of your interactive whiteboard described in this guide, go to smarttech.com/software and ensure that you have the latest version of SMART software and SMART Product Drivers installed on your computer. You can also use your SMART Podium 500 series interactive pen display with a SMART GoWire™ auto-launch cable with SMART Meeting Pro software.

Tethered pen and magnetic pen holder

Control your computer and comfortably write over any application from the interactive pen display using the ergonomic soft-grip tethered pen. You can rest your hand naturally on the interactive display as you write in SMART Ink since the tethered pen is your interactive point of contact on the screen. The tethered pen is battery-free so you never incur additional costs for replacement batteries. Securely rest the tethered pen in the magnetic pen holder when you're finished writing so you always know where to locate the tethered pen.

SMART Ink

SMART Ink smoothes out the appearance of the digital ink, which improves the legibility of your handwriting as you write over applications, websites and videos.

Illuminated buttons

Using the illuminated buttons on your interactive pen display, you can set the current function of the tethered pen and instantly start SMART software programs. The buttons on the frame are backlit for easy recognition. When you press the **Pen Color**, **Eraser** or **Select** button, the backlight brightens to indicate the active button.

Smooth Tilt Stand

Easily adjust the height of your interactive pen display by pressing the lever on the Smooth Tilt Stand to recline the angle of the unit.

CHAPTER 1

About your SMART Podium interactive pen display

Interactive surface

Your interactive pen display has a liquid crystal display (LCD) screen and acts as an input and output device when you touch it with the tethered pen. The native aspect ratio is 16:9 with flexible scaling options to support 4:3 and 16:10.

Power

The interactive pen display uses a 12V DC power supply adapter, which comes with the unit.

i NOTE

The interactive pen display switches to the appropriate voltage automatically.

Power saving

The interactive pen display conforms to the Video Electronics Standards Association (VESA®) power saving guidelines.

DViT technology

Four digital cameras, one in each corner of the interactive pen display, track the position of the tethered pen as it moves across the interactive surface.

Durable surface

The interactive surface features hardened glass that is scratch-resistant and optimized for projection.

Cables

Connect your interactive pen display to your computer with the included cables. See the *SMART Podium quick connect guide* (smarttech.com/kb/170009) for more information.

Security

Your interactive pen display features a Kensington® security slot on the back of the display. Lock your interactive pen display with a security cable (not included) to help safeguard it from theft.

CHAPTER 1

About your SMART Podium interactive pen display

USB disable

You can mechanically disable the USB A receptacles to prevent users from opening files from or saving files to USB drives using this receptacle. See smarttech.com/kb/170004 for more information.

CAUTION

Only do this if you want to permanently disable the USB A receptacles. Once the USB receptacles are disabled, you cannot enable them again.

HDCP

Your SMART Podium 500 series interactive pen display is HDCP 1.3 compliant.

Optional accessories

For more information on optional accessories, contact your [authorized SMART reseller](#).

Your SMART Podium interactive pen display

Use the illustration below to familiarize yourself with the components of your interactive pen display.

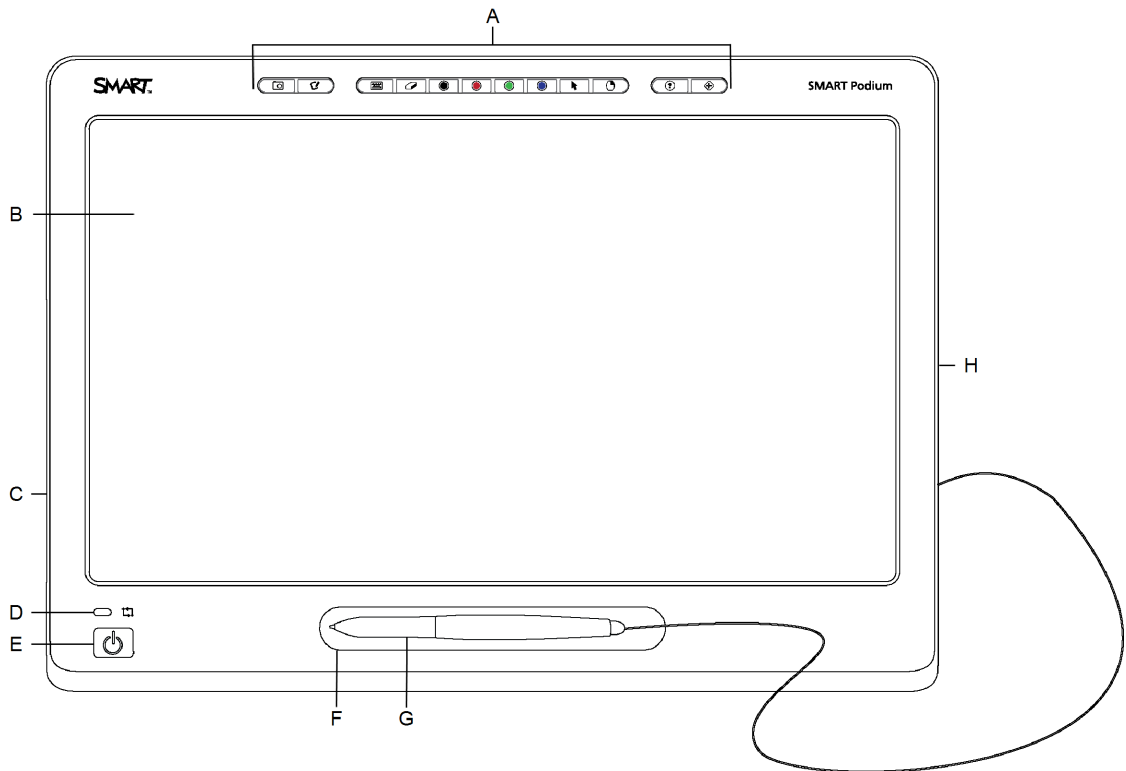

CHAPTER 1

About your SMART Podium interactive pen display

Component	Description
A Illuminated buttons	Press the illuminated buttons for quick access to pen colors and other functions. See <i>Using the illuminated buttons</i> on page 31 for more information.
B Interactive screen	Displays your content on an 18.5" (47 cm) or 24" (61 cm) high definition progressive scan LCD display to show wide format video and high resolution images.
C Control panel	Contains the on-screen display (OSD) control buttons and three USB A 2.0 receptacles. See <i>Control panel</i> on page 8 for more information.
D Status indicator	Indicates the communication status of the interactive pen display. See <i>Checking the status on your interactive pen display</i> on page 46 for more information.
E Power button	Indicates whether power is reaching the interactive pen display. See <i>Checking the power on your interactive pen display</i> on page 44 for more information.
F Magnetic pen holder	Stores the tethered pen when you finish writing so you always know where to locate the pen next.
G Tethered pen	Touch the tethered pen to the interactive pen display surface to control your computer and to write notes over any program or your desktop with digital ink. The tethered pen is battery-free.
H Connection panel	Contains the connections needed to use your interactive pen display with your computer and other devices. See <i>Connection panel</i> on page 9 for more information.

CHAPTER 1

About your SMART Podium interactive pen display

Illuminated buttons

Use the following illustration to familiarize yourself with the buttons on the top of your interactive pen display. See *Using the illuminated buttons* on page 31 for more information.

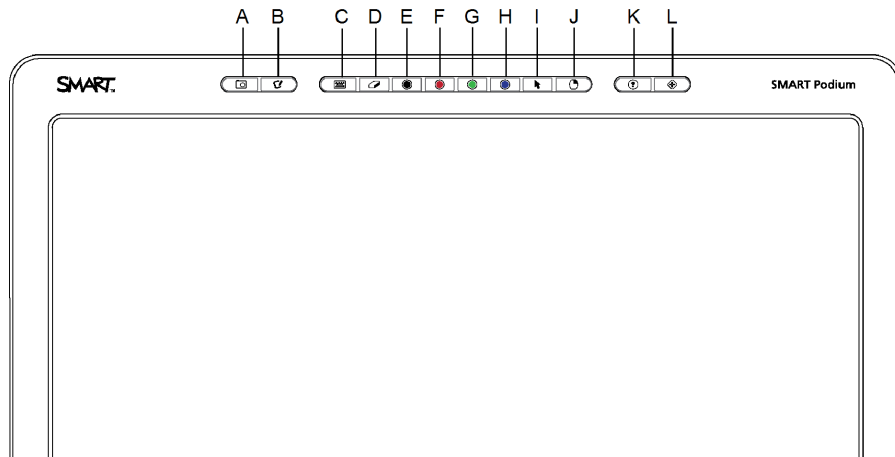

Button	Description
A	Capture
B	Launch software
C	Keyboard
D	Eraser
E	Black color
F	Red color
G	Green color
H	Blue color
I	Select
J	Right-click
K	Help
L	Orient

CHAPTER 1

About your SMART Podium interactive pen display

Control panel

Use the illustration below to locate the on-screen display (OSD) control buttons and connectors on the left side of your interactive pen display.

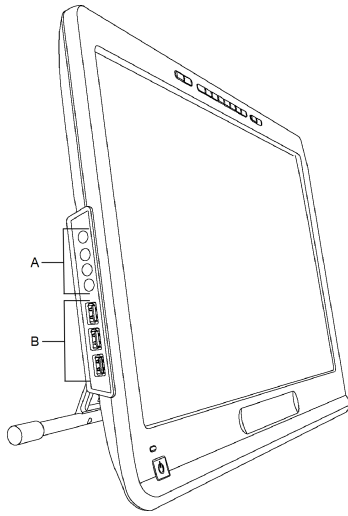

Item		Description
A	OSD control buttons	Use to select and configure options in the on-screen display menu settings. See <i>Changing settings in the OSD menu</i> on page 55 for more information.
B	USB receptacles	Use the three USB A 2.0 receptacles to connect USB devices.



CHAPTER 1

About your SMART Podium interactive pen display

Connection panel

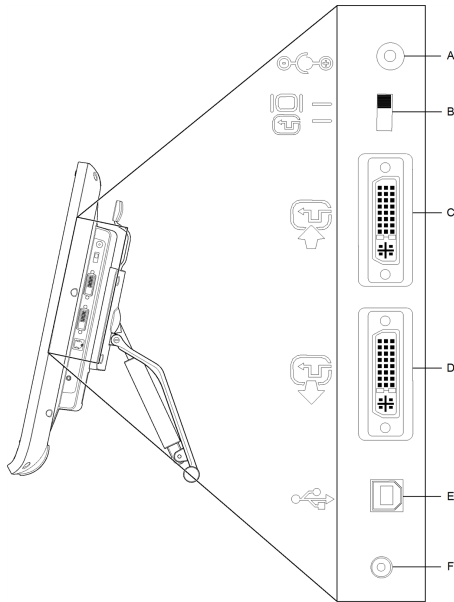
Use the illustration below to locate the connectors on the right side of your interactive pen display.



Connector	Description
A	Power cable receptacle Connects the power cable from your interactive pen display to a DC adapter.
B	Analog/Digital switch Switch to Analog  if you're using a VGA connection or to Digital  if you're using a DVI connection.
C	Video in Connects the DVI-I cable from your interactive pen display to your computer or laptop.
D	Video out Connects the DVI-I cable from your interactive pen display to a second display or device. The second display or device mirrors what appears on your interactive pen display.
E	USB B receptacle Connects the USB cable from your interactive pen display to your computer or laptop.
F	Pen tether receptacle Connects the pen to your interactive pen display.

Chapter 2

Installing your SMART Podium interactive pen display

System requirements.....	11
For Windows operating systems	11
For Mac operating system software.....	12
Video cards.....	12
Monitors and projectors.....	12
Installing your interactive pen display.....	13
Setting up your interactive pen display.....	13
Determining the best location for your interactive pen display.....	13
Setting up your work area.....	14
Changing the angle of your interactive pen display.....	14
Removing and installing the Smooth Tilt Stand.....	15
Orienting your SMART Podium interactive pen display.....	16
Integrating other devices.....	18

This chapter provides additional considerations and details for installing your interactive pen display.

System requirements

Before installing your SMART Podium 500 series interactive pen display, make sure your computer meets the following requirements.

For Windows® operating systems

- Windows Vista®, Windows Vista 64-bit, Windows XP or Windows XP 64-bit operating system
- DVI or VGA video receptacle
- Available USB receptacle

CHAPTER 2

Installing your SMART Podium interactive pen display

For Mac operating system software

- Mac OS X operating system software 10.4 or later
- DVI or VGA video receptacle
- Available USB receptacle

i NOTES

- You need a suitable video adapter to connect the VGA to DVI-A cable or the DVI-D to DVI-D cable.
- For specific system requirements, see the release notes for your SMART Notebook software or SMART Meeting Pro software at smarttech.com/downloads.

Video cards

Your interactive pen display supports both digital (DVI) and analog (VGA) video signals. If you're updating your video card, complete the video card hardware and software installation before connecting your interactive pen display. If you have another display that's compatible with your video card, you can connect that display to the card in order to verify the video card is operating correctly.

Although you can quickly connect the interactive pen display to a video card with either DVI or VGA signals, a DVI signal generally results in better performance. If your display has a digital in and digital out, there will be no conversion in the display.

i NOTE

- Your interactive pen display doesn't convert video signal and simply passes the signal through as it is received. Digital In will be Digital Out and Analog In will be Analog Out.
- Depending on the capabilities of your video card and operating system, you may be able to set up your interactive pen display as a mirrored, extended or independent display. For more information, see your video card documentation.

Monitors and projectors

You can use your interactive pen display as a standalone interactive display or with another display. You can connect a second device, such as a projector or a monitor, to the Video OUT receptacle on your interactive pen display. When connected using the Video OUT, the second device mirrors the image on your interactive pen display. Complete the interactive pen display installation before connecting a second device.

CHAPTER 2

Installing your SMART Podium interactive pen display

NOTE

For more information on configuring your computer and operating system for use with multiple monitors, see your hardware and operating system documentation.

Installing your interactive pen display

To install your interactive pen display, refer to the Quick Connect guide that came with your product. You can also find this document on the SMART Support website at smarttech.com/kb/170009.

Orient your interactive pen display after you install it. See *Orienting your SMART Podium interactive pen display* on page 16 for more information.

CAUTION

- Connect your interactive pen display to a computer with a video card that supports a refresh rate of 76 Hz. If the frequency of the signal is configured higher than 76 Hz, the image may display fine striping (such as screen stripes) or it may appear to flicker or display a wavy pattern.
- An inappropriate video card in your computer may damage the interactive screen of your interactive pen display.

NOTES

- When a still image is displayed for a long period of time, an afterimage can remain for a short time. To prevent this, use a screen saver or other power management feature.
- To display HDCP content, your video card also needs to be HDCP 1.3 compliant.

Setting up your interactive pen display

Before you use your interactive pen display, make sure you determine the best location, work area and angle for the display.

Determining the best location for your interactive pen display

Install your interactive pen display in a cool, dry location without excessive levels of dust, humidity and smoke. Operate the interactive pen display in an environment within a temperature range of 41°F to 95°F (5°C to 35°C) and within a humidity range of 20% to 80% (non-condensing). You can store the interactive pen display within a temperature range of 14°F to 140°F (-10°C to 60°C) and a humidity range of 20% to 90% (non-condensing).

CHAPTER 2

Installing your SMART Podium interactive pen display

Take into consideration that the interactive pen display generates heat when it is turned on. To maintain a consistent operating temperature, do not block or cover any of the ventilation holes on the back of the unit. Other external factors can affect the interactive pen display, such as the heat generated by control systems or other electronic equipment. Make sure there is adequate airflow around the unit.

Use your computer's mouse and keyboard to install SMART Product Drivers before you install your interactive pen display. Your interactive pen display cannot provide keyboard or tethered pen functionality until you install SMART Product Drivers. You should also keep your computer within 16' (5 m) of the unit or use an active USB extender. This protects against signal degradation that occurs with a longer USB cable. The video cable also has length limitations, so you shouldn't use an RGB video cable longer than 50' (15 m).

Setting up your work area

Organize your work area so you can work comfortably. Position your interactive pen display and your keyboard for easy access without unnecessary reaching. You should be able to comfortably view the interactive pen display and any other displays with a minimum of eye strain.

Because the interactive pen display surface is a little higher than your desk, you can adjust the height of your chair to ensure comfortable use of the device.

You can also mount the interactive pen display onto articulated arms or other third-party stands meeting the VESA 100 specification for display stands.

Changing the angle of your interactive pen display

You can recline the Smooth Tilt Stand to change the angle and height of your interactive pen display. To alleviate glare, you can use the attached Smooth Tilt Stand to angle the interactive pen display.

i NOTE

For information on how to remove the stand, see *Removing and installing the Smooth Tilt Stand* on the next page.

■ To change the height of the interactive pen display

1. Grab the top of the interactive pen display and use your fingers to press the lever at the top of the stand.
2. Push the interactive pen display down or up to adjust the angle of the display.

CHAPTER 2

Installing your SMART Podium interactive pen display

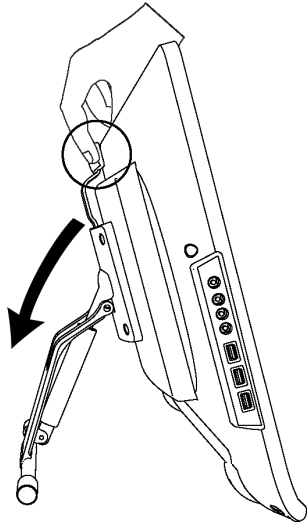

Removing and installing the Smooth Tilt Stand

You can remove the interactive pen display from its stand.

CAUTION

- Carefully set down the interactive pen display to ensure you do not damage the buttons.
- Do not place the interactive pen display on a surface that can mark, scratch or damage the screen.

To remove the Smooth Tilt Stand

1. Place the interactive pen display facedown on a flat surface.
2. Remove the four screws that attach the stand to the VESA mount on the back of the interactive pen display, and then remove the stand.

To install the Smooth Tilt Stand

1. Place the interactive pen display facedown on a flat surface.
2. Place the stand down on the back of the interactive pen display with the lever pointed to the top of the display.
3. Align the four holes in the stand with the four holes in the back of the interactive pen display.

CHAPTER 2

Installing your SMART Podium interactive pen display

4. Insert and tighten the four screws to the VESA mount.

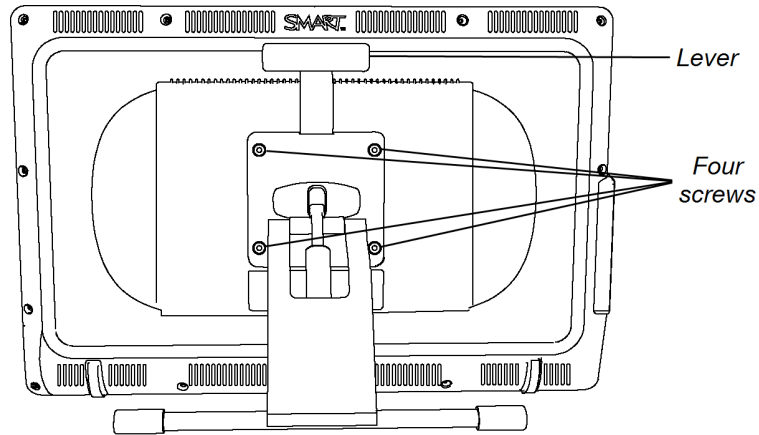

Orienting your SMART Podium interactive pen display

When the location of your pen touch is misinterpreted (ink appears a distance from the actual pen contact), orient your interactive pen display.

■ To orient the interactive pen display

1. Press **Orient**  on the right side of the illuminated button panel at the top of your interactive pen display.

NOTE

If the interactive pen display is your secondary monitor, you may need to press the SPACE BAR to move the orientation screen to your interactive pen display.

CHAPTER 2

Installing your SMART Podium interactive pen display

2. If the below tracking screen appears, press the tethered pen to the screen at the start of the track, and then use the tethered pen to draw a path to the end of the track.

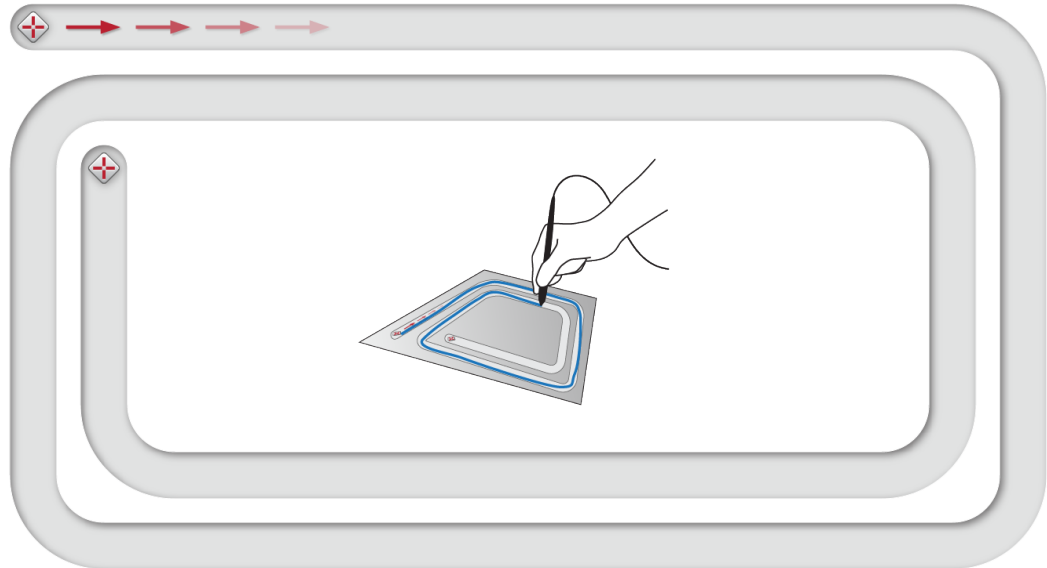

IMPORTANT

Do not rest your wrist or the palm of your hand on the screen because your touch will interfere with the orientation process.

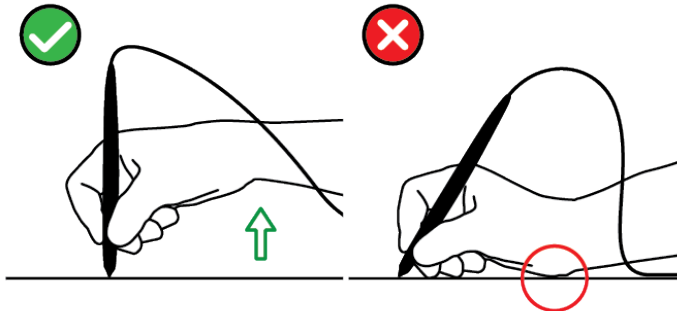

3. Lift the tethered pen from the screen when you come to the end of the track.
The orientation screen opens and a target  appears on the screen.

CHAPTER 2

Installing your SMART Podium interactive pen display

4. Use the tethered pen to press the center of the target.

TIPS

- To accurately orient the screen, press the tethered pen to the screen near the first target. Slide the tethered pen across the screen to the center of the target. Briefly hold the tethered pen to the center of the target before removing the tethered pen from the screen. Repeat for each target that appears.
- You can orient a target again by pressing **Orient** on the illuminated button panel or the LEFT ARROW key on your keyboard.
- Press the ESC key on your keyboard if you want to close the orientation screen before you finish the orientation procedure. Otherwise, the orientation screen closes after you press the last target.

5. Lift the pen off the surface of your interactive pen display.

NOTE

The computer registers the point on the screen where you remove your pen from the display surface.

The target moves to the next orientation point.

6. Repeat steps 4 to 5 until you press all targets.

The orientation window closes.

Integrating other devices

You can connect another device, such as a projector, a monitor or a SMART Board™ interactive whiteboard, directly to the interactive pen display. With this setup, whatever you view on the interactive pen display also appears on the other display. When you connect a projector or a monitor, the video signal from the computer is automatically sent to the projector or monitor. Other integration options are available if you amplify the video signal.

NOTE

The display resolution of the connected computer must be set to a resolution supported by the projector.

CHAPTER 2

Installing your SMART Podium interactive pen display

To connect a projector or monitor

For DVI operation, connect a second DVI to DVI video cable (not included) to the Video out receptacle located on the interactive pen display and the DVI-D or DVI-I Video Input connector on your other device.

OR

For VGA operation, connect a second VGA to DVI-A cable (not included) to the Video out receptacle located on the interactive pen display and the VGA Video Input connector on your other device.

NOTES

- For details about your other device's connectors, read the instructions that came with your device.
- If you want to use a video cable longer than 50' (15 m), you must boost the video signal with a video distribution amplifier. To display HDCP content, your amplifier also needs to be HDCP 1.3 compliant.

Chapter 3

Installing SMART software

Installing SMART Notebook software.....	21
Installing SMART Meeting Pro software.....	22

You need to install SMART software on the computer that's connected to your interactive pen display in order to use your interactive pen display.

SMART software includes the following:

- SMART Product Drivers, which enables digital ink
 - SMART Notebook software
- OR
- SMART Meeting Pro software

i NOTE

For laptops that will only occasionally be used for your interactive pen display, you can use a SMART GoWire auto-launch cable instead of installing SMART software (see *Using a SMART GoWire auto-launch cable* on page 36 for more information).

Installing SMART Notebook software

The SMART Notebook software DVD includes two components in one consolidated installation:

- SMART Product Drivers
- SMART Notebook software

For specific system requirements, see the release notes for your SMART Notebook software at smarttech.com/downloads.

 **IMPORTANT**

- Connect to the Internet before you install SMART software so that you can obtain a software activation key and download software updates.
- Register your software to obtain a product key for activation. If you do not obtain a product key, you can use SMART Notebook software for 30 days.

 **To install SMART Notebook software and SMART Product Drivers**

1. Place the included installation DVD in your computer's DVD tray.

The installation wizard appears.

2. Follow the on-screen instructions and enter your product activation key when prompted. Register your interactive pen display online using the serial number found in the middle of the label on the back of your interactive pen display.

 **NOTE**

You can find the serial number on the interactive pen display in the following locations:

- on the bottom center of the back of the interactive pen display
- on the bottom right of the back of the interactive pen display

3. Click the **SMART** software icon  in the notification area (Windows operating systems) or the Dock (Mac operating system software), and then select **Check for Updates**.

The *SMART Product Update* screen appears.

4. Follow the on-screen instructions to install or update your SMART Notebook software and SMART Product Drivers to their most recent versions.

Installing SMART Meeting Pro software

Your SMART GoWire auto-launch cable includes both SMART Product Drivers and SMART Meeting Pro software pre-installed and activated. See *Using a SMART GoWire auto-launch cable* on page 36

Your SMART GoWire auto-launch cable also includes a product key for one SMART Meeting Pro software activation on your computer. The SMART Meeting Pro software download includes two components in one consolidated installation:

- SMART Product Drivers
- SMART Meeting Pro software

CHAPTER 3

Installing SMART software

This software requires a computer with a Windows operating system. For specific system requirements, see the release notes for your SMART Meeting Pro software at smarttech.com/downloads.



IMPORTANT

If you do not activate your software, you can use SMART Meeting Pro software for 30 days.

■ To download SMART Meeting Pro software and SMART Product Drivers

1. Go to www.smarttech.com/downloads.
2. Scroll to **SMART Meeting Pro software**, click *Choose a version*, and then select the latest version of **SMART Meeting Pro software**.
3. Click **Download**.
4. Follow the on-screen instructions to save the executable file to your desktop.

■ To install SMART Meeting Pro software and SMART Product Drivers

1. Double-click the executable file.
2. Follow the on-screen instructions, and enter your product activation key when prompted. Register your interactive pen display online using the serial number found in the middle of the label on the back of your interactive pen display.
3. Click the **SMART Meeting Pro** icon  in the notification area, and then select **Check for Updates**.
The *SMART Product Update* window appears.
4. Follow the on-screen instructions to install or update your SMART Meeting Pro software and SMART Product Drivers to their latest versions.

Chapter 4

Using your SMART Podium interactive pen display

Turning your interactive pen display on and off.....	26
Using the tethered pen	26
Tethered pen components.....	27
Writing or drawing digital ink.....	28
Erasing digital ink.....	28
Changing eraser settings.....	29
Manipulating objects with the tethered pen.....	29
Entering text on the interactive pen display.....	30
Using the illuminated buttons.....	31
Working with Ink Aware applications.....	31
Viewing a list of Ink Aware applications.....	32
Disabling Ink Aware.....	32
Working with non-Aware applications.....	33
Capturing and saving your notes.....	34
Clearing all notes from the screen.....	34
Restoring cleared notes.....	34
Closing the transparent layer.....	35
Customizing the transparent layer.....	35
Using a SMART GoWire auto-launch cable.....	36

This chapter describes the basic operation of your interactive pen display such as how to write and erase digital notes and how to work with Ink Aware applications.

CHAPTER 4

Using your SMART Podium interactive pen display

Turning your interactive pen display on and off

Use the following directions to turn your interactive pen display on and off.

■ To turn your interactive pen display on

Press the **Power** button on the front left side of the interactive pen display.

NOTES

- If the Power button indicator light on the front of the interactive pen display is off, the interactive pen display isn't plugged in.
- Your interactive pen display will automatically turn off after one minute without video input.

■ To turn your interactive pen display off



Press the **Power** button on the front left side of the interactive pen display.

Using the tethered pen

You can use the tethered pen to select, control, move and manipulate items and objects on your screen. You can also write notes and draw on your screen in digital ink.

The tethered pen for the interactive pen display is battery-free with an ergonomic soft grip. Hold the tethered pen like you would a normal pen or pencil. As you work with your interactive pen display, you can rest your hand on the display screen, just as if it were a sheet of paper. You can tilt the tethered pen in any way that feels most comfortable for writing or drawing.

IMPORTANT

You can write notes over applications and your desktop only if SMART Product Drivers are running on your computer. If you see the  or  icon in the Windows notification area or Mac Dock, SMART Product Drivers is not running on your computer or your product is not properly connected.

CHAPTER 4

Using your SMART Podium interactive pen display

TIPS

- When the tethered pen isn't in use, place it in the magnetic pen holder on the front of your interactive pen display.
- You can use SMART Notebook software or SMART Meeting Pro software to make your presentations interactive and dynamic. For more details on what you can accomplish with SMART Notebook software or SMART Meeting Pro software, see your SMART software's online Help.

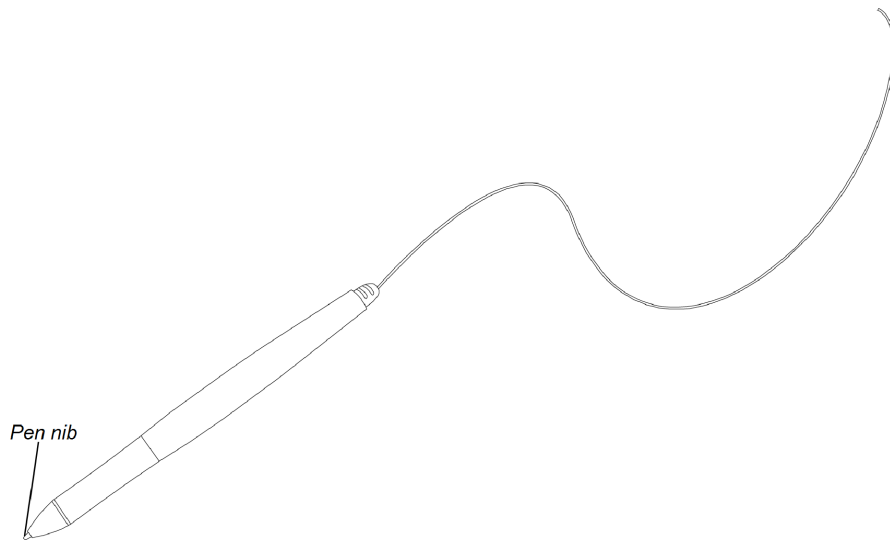

Tethered pen components

Component	Description
Pen nib	Press a Pen Color button, and then touch the pen nib to the screen surface to write with digital ink.

TIP

Press the pen nib to the screen firmly to make digital ink appear.

CAUTION

Replace the tethered pen when the pen nib wears down. If a pen nib wears down too far, you might scratch or damage the interactive pen display surface.

CHAPTER 4

Using your SMART Podium interactive pen display

Writing or drawing digital ink

You can use the tethered pen to write or draw in digital ink over SMART Notebook software, SMART Meeting Pro software and other programs.

■ To write or draw digital ink

1. Pick up the tethered pen.
2. Press one of the **Pen Color** buttons from the illuminated button panel.

A transparent layer (also referred to as the Ink Layer) appears as a frame around your screen.

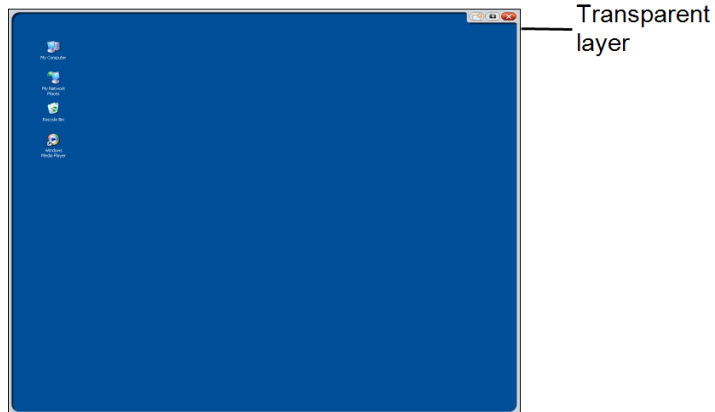

3. Write or draw on the transparent layer to make notes and draw over your desktop and other non-Aware programs.

i NOTE

See *Working with non-Aware applications* on page 33 for more information on using the transparent layer.

Erasing digital ink

You can use the tethered pen to erase digital ink.

■ To erase digital ink

1. Press **Eraser**  on the illuminated button panel.
2. Press the tethered pen to the screen and move it over the digital ink you want to erase.

Changing eraser settings

You can change the default eraser size to either a larger or smaller eraser area.

■ To change eraser settings

1. Press the **SMART software** icon  in the notification area (Windows computers) or the Dock (Mac computers), and then select **Control Panel**.

OR

Press the **SMART Meeting Pro** icon  in the notification area, and then select **Control Panel**.

The SMART control panel appears.

2. Press **SMART Hardware Settings**.
3. Select **Pen and Button settings** in the drop-down list.
4. Press **Eraser Settings**.
5. Select an eraser size.
6. Press **OK** to save your settings.
7. Press **OK** to close the control panel.

Manipulating objects with the tethered pen

Objects include icons, buttons, links and other components of applications that appear on your screen. You can manipulate these objects by pressing your tethered pen to the screen of your interactive pen display as described below.

■ To select an object

Press **Select**  from the illuminated button panel, and then press the tethered pen to the screen to select the object.

CHAPTER 4

Using your SMART Podium interactive pen display

NOTES

- This pen gesture performs a standard mouse click.
- This pen gesture starts programs if your operating system is set to start applications on a single click.

To double-click an object

Press **Select**  from the illuminated button panel, and then quickly press and release the object twice with the tethered pen.

TIP

You can use this procedure to start applications if your operating system is set to start applications on a double-click.

To right-click or control-click an object

Press **Right-click**  from the illuminated button panel, and then press the tethered pen to the screen once.

The right-click menu appears.

To move an object

1. Hold the tethered pen down on the object you want to move.
2. Keeping the tethered pen on the screen, slowly drag the object.
3. When you reach the desired position, release the object.

Entering text on the interactive pen display

You can enter text to text boxes on the interactive pen display with the on-screen keyboard or a keyboard connected to your computer.

To enter text with the on-screen keyboard

1. Select the area where you want to enter text.
2. Press **Keyboard**  from the illuminated button panel.













CHAPTER 4

Using your SMART Podium interactive pen display

3. Touch the tethered pen to the on-screen keyboard's keys to enter text.

Using the illuminated buttons

Press the following illuminated buttons to perform the following functions.

Button		Description
	Capture	Press this button to launch the Screen Capture Toolbar.
	Launch software	Press this button to launch SMART Notebook software or SMART Meeting Pro software.
	Keyboard	Press this button to launch the on-screen keyboard.
	Eraser	Press this button to erase ink from your screen with the tethered pen.
	Black ink	Press this button to write on your screen in black ink with the tethered pen.
	Red ink	Press this button to write on your screen in red ink with the tethered pen.
	Green ink	Press this button to write on your screen in green ink with the tethered pen.
	Blue ink	Press this button to write on your screen in blue ink with the tethered pen.
	Select	Press this button to use the tethered pen to select objects, control your computer and to left-click.
	Right-click	Press this button to use the tethered pen to perform a right-click or control-click on the screen.
	Help	Press this button to launch the online Help for SMART Notebook software or SMART Meeting Pro software.
	Orient	Press this button to start the orientation procedure.

Working with Ink Aware applications

When you write over an application that's Ink Aware, the application recognizes your notes and integrates them into your file as an object or as typed text. SMART Notebook software and SMART Meeting Pro software are examples of Ink Aware applications. Microsoft Word, Excel® and PowerPoint® are also Ink Aware.

CHAPTER 4

Using your SMART Podium interactive pen display

To save your notes as part of the file in an Ink Aware application, save the file as you normally would. In some Windows applications, such as Word and Excel, you can select additional options from the Ink Aware toolbar. You can use this toolbar to save your notes to a .notebook file or to save your notes as text. Refer to your SMART software's online Help for more information on the Ink Aware toolbar.

If the interactive pen display is connected to a Windows computer, you can capture your notes and the application background, and then you can save them to a .notebook file for both Aware and non-Aware applications. See the SMART Notebook software or SMART Meeting Pro software online Help for more information on using Ink Aware applications.

Viewing a list of Ink Aware applications

You can open and view a list of Ink Aware applications in the SMART control panel.

To view a list of Ink Aware applications

1. Press the **SMART software** icon  in the Windows notification area or the Mac Dock, and then select **Control Panel**.

OR

Press the **SMART Meeting Pro** icon  in the notification area, and then select **Control Panel**.

The SMART control panel appears.

2. Press **Configure SMART Tools**.
3. Press **Ink Aware Program Settings**.

The *Aware* window appears displaying the list of Ink Aware applications.

TIP

If a check mark appears in the *Aware Enabled* column, that application's Ink Aware features are enabled. Clear the check box to disable an application's Ink Aware features.

Disabling Ink Aware

You can disable the Ink Aware features for a specific application or for all applications.

CHAPTER 4

Using your SMART Podium interactive pen display

i NOTE

When you disable Ink Aware, the application becomes non-Aware. You can still write over your screen using the transparent layer, but the application won't recognize your notes or integrate them into your file. See *Working with non-Aware applications* below for more information on writing on the transparent layer.

■ To disable Ink Aware

1. Press the **SMART software** icon  in the Windows notification area or the Mac Dock, and then select **Control Panel**.

OR

Press the **SMART Meeting Pro** icon  in the notification area, and then select **Control Panel**.

The SMART control panel appears.

2. Press **Configure SMART Tools**.
3. Press **Ink Aware Program Settings**.

The *Aware* window appears displaying the list of Ink Aware applications.

4. Clear the check box in the *Aware Enabled* column to disable that application's Ink Aware features.

Working with non-Aware applications

If an application is non-Aware, whatever you write or draw on your screen is written on a transparent layer (also referred to as the Ink Layer) that appears over the current application. The transparent layer also appears when you try to write or draw over your desktop.

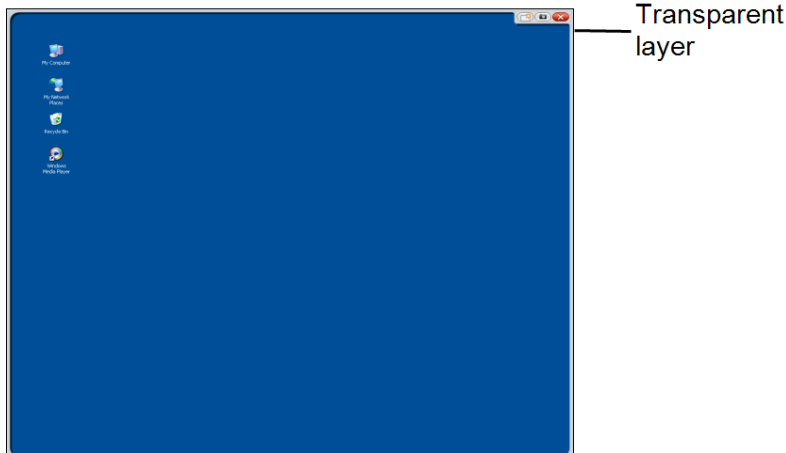

CHAPTER 4

Using your SMART Podium interactive pen display

After you finish writing and drawing on the transparent layer, you can save or clear your notes. If you mistakenly clear your notes, you can restore them.

NOTE

You can customize the transparent layer. For more information on how to use the transparent layer to draw over non-Aware applications, see your SMART Notebook software or SMART Meeting Pro software online Help.

Capturing and saving your notes

You can save your notes at any time.

To capture and save your notes

1. Press **Capture**  in the upper right corner of the transparent layer.
Your screen capture appears as an image on a page in SMART Notebook software or SMART Meeting Pro software.
2. Select **File > Save** to save your screen capture in a .notebook file.

TIP

If you want to save your notes but don't want to take a capture of the entire screen, you can use the Screen Capture toolbar for more capture options. See your SMART Notebook software or SMART Meeting Pro software online Help for more information.

Clearing all notes from the screen

You can clear your notes at any time.

To clear all notes from the screen

Press **Clear**  in the upper-right corner of the transparent layer.

Restoring cleared notes

If you mistakenly clear your notes, you can restore them. You can also restore them after you close the transparent layer.

To restore cleared notes

Press **Undo**  on the Floating Tools toolbar (SMART Notebook software) or the SMART Business Toolbar (SMART Meeting Pro software).

CHAPTER 4

Using your SMART Podium interactive pen display

NOTE

For more information on tools available, refer to your SMART software's online Help.

To restore cleared notes after you close the transparent layer

Press the **Click here to restore ink** thumbnail image that appears in the bottom-right of your screen. The image appears for five seconds after the transparent layer is closed.

Closing the transparent layer

You can close the transparent layer at any time.

To close the transparent layer

Press **Close**  in the upper right corner of the transparent layer.

NOTES

- Your notes clear when you close the transparent layer.
- If you want to save your notes, take a screen capture before you close the transparent layer (see *Capturing and saving your notes* on the previous page).
- If you mistakenly clear your notes, you can restore them (see *Restoring cleared notes* on the previous page).

Customizing the transparent layer

You can customize the transparent layer (also referred to as the Ink Layer).

To customize the transparent layer

1. Press a **Pen Color**  button from the illuminated button panel.
A transparent layer appears over the current program.
2. Right-click, and then select **Ink Layer Options** in the menu that appears.
The *Ink Layer Settings* dialog box appears.

CHAPTER 4

Using your SMART Podium interactive pen display

3. Adjust the following settings:

- Clear the **Show border around ink layer** check box to display the transparent layer without a border.
- Clear the **Allow pop-up balloon messages** check box to prevent the *Click here to restore ink* thumbnail image from appearing after you clear your notes.
- Clear the **Screen Capture, Clear, and Close buttons** check box to prevent these options from appearing in the upper-right corner of the transparent layer.
- Select the **Close ink layer with pointer** check box to disable the menu options that appear when you click the transparent layer with the tethered pen.

NOTE

When this feature is enabled, a single pen touch closes the transparent layer and automatically clears your notes.

- Select the **Always Save Ink** check box if you want your notes to be automatically captured to a .notebook when you close the transparent layer.

Using a SMART GoWire auto-launch cable

Any computer connected to your interactive pen display requires SMART software. You install this software on your room computer so that it's always ready for use (see *Installing SMART software* on page 21 for more information).

If you want to connect a computer or laptop that doesn't have SMART software installed, you can connect a SMART GoWire auto-launch cable. The SMART GoWire auto-launch cable contains both SMART Product Drivers and SMART Meeting Pro software and starts them automatically.

IMPORTANT

Your SMART Podium 500 series interactive pen display supports only SMART GoWire auto-launch cable for SMART Meeting Pro 2.3 software. It does not support earlier versions or SMART GoWire auto-launch cable for SMART Notebook software.

To use a SMART GoWire auto-launch cable

1. Ensure your computer or laptop is properly connected to your interactive pen display (see *Installing your SMART Podium interactive pen display* on page 11 for more information).
2. Connect the USB A connector on the SMART GoWire auto-launch cable to a USB receptacle on your computer or laptop.

CHAPTER 4

Using your SMART Podium interactive pen display

3. Connect the USB B connector on the SMART GoWire auto-launch cable to the USB B receptacle on your interactive pen display connection panel.

SMART software begins to activate and the *AutoPlay* dialog box appears.

NOTE

SMART software isn't being installed on your computer or laptop. It runs from the SMART GoWire auto-launch cable.

4. Select the **Start SMART Meeting Pro** option.

SMART Meeting Pro software opens. You can use SMART Meeting Pro software while your SMART GoWire auto-launch cable is connected.

To disconnect a SMART GoWire auto-launch cable

1. Save your SMART Meeting Pro software file to your computer or laptop, if required. You can save the file as a .ppt, .pdf or .notebook file.

IMPORTANT

You can open a .notebook file only on a computer with SMART Meeting Pro software installed, or on one connected to a SMART interactive product through a SMART GoWire auto-launch cable.

2. Press the **SMART Meeting Pro** icon  in the notification area, and then select **Exit**.
3. Disconnect the SMART GoWire auto-launch cable from your computer or laptop and from your interactive pen display.

Chapter 5

Maintaining your SMART Podium interactive pen display

Cleaning the screen	39
Cleaning the camera windows and reflective tape	40
Maintaining ventilation	41
Preventing condensation	41

If you properly maintain your interactive pen display, it will provide years of use.

Cleaning the screen

Follow these instructions to clean the interactive pen display screen without damaging it or other product components. You should clean the screen once a week because dirt and dust can stick to the screen.

CAUTION

- Use only a damp cloth to clean the screen. Do not apply glass cleaner, organic solvents (such as alcohol), or even a mild detergent to the screen. If you use these cleaners, you may damage the screen's finish or the unit's electronics. Using such cleaners also voids the warranty.
- Do not use permanent or dry erase markers on the screen. If dry-erase markers are used on the screen, remove the ink as soon as possible with a lint-free, non-abrasive cloth.
- Do not rub the screen with a dense or rough material.
- Do not apply pressure to the screen.
- Avoid touching the black reflective tape between the screen and the bezel and ensure that it stays dry. Damage to this strip affects touch interactivity.

CHAPTER 5

Maintaining your SMART Podium interactive pen display

■ To clean the screen

1. Shut down your computer, and then disconnect the power sources for your computer and your interactive pen display.
2. Wipe the screen with a lint-free, non-abrasive, anti-static cloth.

Cleaning the camera windows and reflective tape

The DVIT technology in your display uses four cameras in the corners of the display and the reflective material between the screen and the bezels. Excessive dust buildup on the camera windows or reflective tape can impair touch performance.

These areas should be inspected annually for dust and should be cleaned if any obvious dust buildup has occurred.

▲ CAUTION

- Do not use compressed air to clean the camera windows or borders.
- Use only water to dampen the cloth. Do not use chemicals or cleaning agents.

■ To clean the camera windows and the reflective tape

1. Lightly moisten a clean lint-free cloth with water.
2. Using the cloth, gently wipe the camera windows in the top corners and the reflective tape along the top of your interactive pen display screen.
3. Gently wipe the reflective tape along the sides of your interactive pen display screen.
4. Gently wipe the camera windows in the bottom corners and the reflective tape across the bottom of your interactive pen display screen.
5. Dry the reflective tape with a clean lint-free cloth.

Maintaining ventilation

Your interactive pen display requires ventilation to enable the fans to cool the unit. Dust buildup in the ventilation holes compromises cooling and leads to product failure.

CAUTION

- Avoid setting up or using your interactive pen display in an area with excessive levels of dust, humidity or smoke.
- Clean accessible ventilation holes with a dry cloth monthly.
- Use a vacuum cleaner with a narrow hose end fitting to clear the back ventilation holes annually.

Preventing condensation

Your interactive pen display screen contains layers of glass that can collect condensation, especially in the following conditions:

- Temperature extremes with high humidity
- Rapid changes in humidity, which occurs when you operate the product near water, such as a sink, pool, kettle or air conditioner ventilator
- Direct exposure to sunlight

Avoid these conditions.

Chapter 6

Troubleshooting your SMART Podium interactive pen display

Checking the power on your interactive pen display.....	44
Power button indicator issues.....	44
Checking the status on your interactive pen display.....	46
Status indicator issues.....	47
Tethered pen issues.....	47
Image issues.....	48
VGA display issues.....	50
Control and writing issues.....	51
Mac-specific issues.....	52
Removing ink preference files on Mac computers.....	53

This chapter provides you with the information necessary to solve simple issues that could occur with your interactive pen display.

Checking the power on your interactive pen display

The Power button lights up to indicate whether power is reaching the interactive pen display.

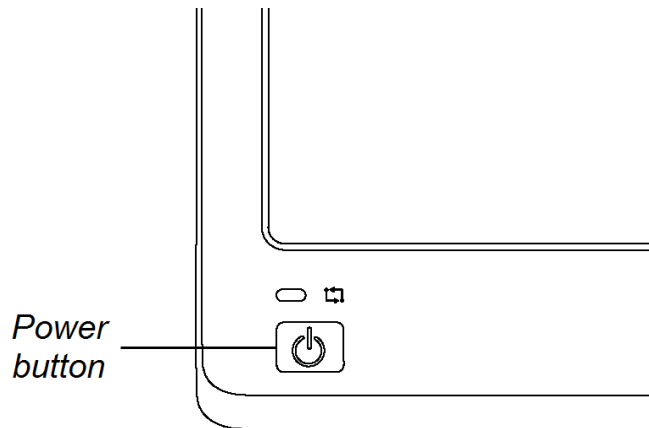

If the power button indicator is...	The interactive pen display is...
solid green	turned on and operating normally
flashing green	warming up
solid amber	idle
off	not receiving power

Power button indicator issues

If you encounter issues with the Power button indicator, refer to the following table.

Symptom	Solution
The Power button indicator is green but you're unable to see an image on the display.	See <i>Image issues</i> on page 48.

CHAPTER 6

Troubleshooting your SMART Podium interactive pen display

Symptom	Solution
The Power button indicator turns amber after being green for a time with no video output.	<ul style="list-style-type: none">• Make sure the length of the video cable doesn't exceed 50' (15 m).• Turn off your computer and make sure:<ul style="list-style-type: none">◦ the video cable is correctly connected to the interactive pen display and the computer;.◦ the video cable isn't bent or broken and doesn't have bent or broken pins in either connector; and <div data-bbox="829 562 1471 699" style="background-color: #f0f0f0; padding: 5px;"><p>i NOTE</p><p>If you're using a video cable adapter, check those connections as well.</p></div> <ul style="list-style-type: none">◦ the video card in your computer is installed correctly, and is operating properly.• If the problem persists, see <i>Image Problems</i> on page 42.
The Power button indicator is off.	<ul style="list-style-type: none">• Make sure the power cable is connected properly.• If the Power button indicator still doesn't turn on, contact SMART Technical Support.

Checking the status on your interactive pen display

The Status indicator shows whether the pen is interacting with the display.

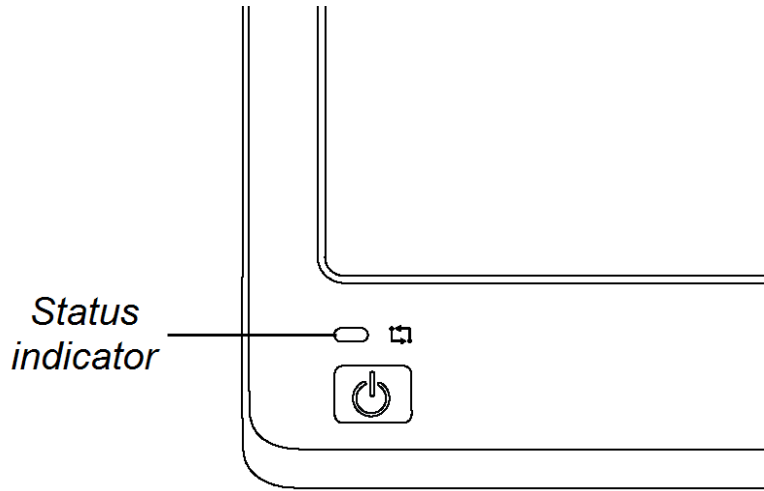

If the Status indicator is...	The interactive pen display is...
solid green	communicating with SMART Product Drivers and operating normally
flashing green	not communicating with SMART Product Drivers
solid red	not communicating with your computer
solid amber	receiving power but not turned on
off	not receiving power

Status indicator issues

If you encounter issues with the Status indicator, refer to the following table.

Symptom	Solution
The Status indicator is flashing green.	<ul style="list-style-type: none"> • Make sure SMART Product Drivers are installed on your computer (see <i>Installing SMART software</i> on page 21). • Make sure SMART Board service is running on your computer. <ol style="list-style-type: none"> a. Open the SMART Control panel, and then select About Software and Product Support > Tools > Diagnostics. b. If the <i>Status</i> field contains a "SMART Board service is not running" message, click the Service menu, and then select Start.
The Status indicator is red.	<ul style="list-style-type: none"> • Make sure the USB cable is properly connected to an active port on the computer and to the interactive pen display. • Make sure the computer's USB interface isn't disabled.
The Status indicator is off.	<ul style="list-style-type: none"> • Make sure the power cable is connected properly. • If the Status indicator still doesn't turn on, contact SMART Technical Support.

Tethered pen issues

If you encounter issues with the tethered pen, refer to the following table.



Symptoms	Solution
You're unable to use the pen to select, write, erase or move the mouse.	<ul style="list-style-type: none"> • Check the Status indicator. If it's red, see <i>Status indicator issues</i> above for troubleshooting information. • Make sure the tethered pen is properly connected to your interactive pen display.
When you write or draw with the pen, you see a pointer instead of digital ink.	<ul style="list-style-type: none"> • Check the Status indicator. If it's flashing green, see <i>Status indicator issues</i> above for troubleshooting information. • Make sure you have selected an ink color from the illuminated buttons at the top of your interactive pen display. • Make sure the SMART Board Diagnostics window isn't open. • If the tethered pen still doesn't work, contact SMART Technical Support.

Symptoms	Solution
You're unable to double-click.	<ul style="list-style-type: none"> • Check the Status indicator. If it's red, see <i>Status indicator issues</i> on the previous page for troubleshooting information. • Adjust the Double-click Zone setting. <ol style="list-style-type: none"> a. Open the SMART Control panel, and then select SMART Hardware Settings > Mouse and Gesture Settings. b. Adjust the Double-click Zone setting, and then select Okay.

Image issues

If you encounter issues with the image on your interactive pen display, refer to the following tables. For additional information about color issues, see the documentation that came with your operating system or applications.

Symptoms	Solution
The display shows no image and the Power button indicator is off.	<ul style="list-style-type: none"> • Make sure the power adapter is connected.
The display shows no image and the Power button indicator is green.	<ul style="list-style-type: none"> • Ensure the video cable is properly connected. • Use the OSD options to return the current display parameters to the factory default settings. See <i>Adjusting video settings with the on-screen display (OSD) menu</i> on page 55.
The display shows no image and the Power button indicator is amber.	<ul style="list-style-type: none"> • Press the Power button to turn the interactive pen display on.

Symptoms	Solution
The display shows the “NO SIGNAL” message.	<ul style="list-style-type: none"> • Make sure your computer is turned on. • Make sure your computer isn’t in Power Management mode. To bring it out of Power Management mode, press any key on your keyboard, or touch the tethered pen to your interactive pen display. • Make sure the Analog/Digital switch on the side of your interactive pen display is set correctly (see <i>Connection panel</i> on page 9 for more information). <div style="background-color: #f0f0f0; padding: 10px; margin: 10px 0;"> <p>i NOTE</p> <p>Switch to Analog  if you’re using a VGA connection or to Digital  if you’re using a DVI connection. Restart your computer after changing the position of the switch.</p> </div> <ul style="list-style-type: none"> • Turn your computer and the interactive pen display off, and then make sure: <ul style="list-style-type: none"> ◦ the video cable’s connector pins aren’t bent or broken. ◦ the video card in your computer is installed correctly, and is operating properly.
The display show the “OUT OF SCAN RANGE” message.	<ul style="list-style-type: none"> • Make sure the input video signal frequency setting is 60 Hz which is compatible with the interactive pen display. • Make sure the video card’s resolution is 1366 × 768 or lower if you’re using a SMART Podium 518 interactive pen display. • Make sure the video card’s resolution is 1920 × 1080 or lower if you’re using a SMART Podium 524 interactive pen display. • Make sure the refresh rate (horizontal frequency) is 30 to 80 Hz. <div style="background-color: #f0f0f0; padding: 10px; margin: 10px 0;"> <p>💡 TIP</p> <p>On a single monitor system, connect a second monitor to change the refresh rate.</p> </div> <ul style="list-style-type: none"> • Make sure the refresh rate (vertical frequency) is 56 to 76 Hz. • Set the display properties to detect plug and play monitors.
The screen flashes multiple times.	<ul style="list-style-type: none"> • Make sure the refresh rate (vertical frequency) is 56 to 76 Hz. • If you’re using an input selector switch box check your hardware connections.

Symptoms	Solution
Color quality is inaccurate	Use the OSD options to return the current display parameters to the factory default settings. i NOTE See <i>Adjusting video settings with the on-screen display (OSD) menu</i> on page 55
When an image appears for a long time without refreshing the screen, an after image remains.	Use a screen saver or other power management feature.

VGA display issues

If you encounter image issues with your interactive pen display with a VGA connection, refer to the following table.

Symptom	Solution
The display ripples or flickers.	<ul style="list-style-type: none"> Use the OSD options to return the display parameters to the factory default settings. Use OSD options to adjust the phase and pitch (VGA only). Make sure the display adapter or video card matches the specifications for the interactive pen display. Adjust the refresh rate in the <i>Display Properties</i> control panel. i NOTE See <i>Adjusting video settings with the on-screen display (OSD) menu</i> on page 55 i NOTE Some video cards might not show the size of the display correctly.
The display ripples or shows a wavy pattern. OR The display color isn't even.	<ul style="list-style-type: none"> Select Auto Adjust in the OSD options to automatically optimize the display screen image (VGA only). If necessary, use the OSD options to adjust the phase and pitch (VGA only). Use the OSD options to return the display parameters to the factory default settings. i NOTE See <i>Adjusting video settings with the on-screen display (OSD) menu</i> on page 55

Symptom	Solution
The display isn't clear, and text or other portions of the screen appear blurred.	<ul style="list-style-type: none"> • Make sure the video card's resolution is 1366 × 768 if you're using a SMART Podium 518 interactive pen display. • Make sure the video card's resolution is 1920 × 1080 if you're using a SMART Podium 524 interactive pen display. • Select 1:1 in the <i>Scaling</i> OSD option to display the image at the actual resolution. • Select Auto Adjust in the OSD options to automatically optimize the display screen image (VGA only). If necessary, use the OSD options to adjust the phase and pitch (VGA only). • Turn off the interactive pen display, and then turn it on.
The display and LCD panel aren't lined up. OR The display size isn't correct.	<ul style="list-style-type: none"> • Select 1:1 in the <i>Scaling</i> OSD option to display the image at the actual resolution. • Select Auto Adjust in the OSD options to automatically optimize the display screen image (VGA only). If necessary, use the Other OSD option to adjust the phase and pitch, and the vertical and horizontal positions (VGA only).



i NOTE

See *Adjusting video settings with the on-screen display (OSD) menu* on page 55

Control and writing issues

If you encounter issues with writing and drawing on your interactive pen display, refer to the following table.

Symptom	Solution
The pointer doesn't accurately follow the movement of the pen.	Orient the interactive pen display (see <i>Orienting your SMART Podium interactive pen display</i> on page 16).

Symptom	Solution
You're unable to write in digital ink.	<ul style="list-style-type: none"> • Make sure SMART Product Drivers is installed. • Make sure SMART Board tools is running. <div style="background-color: #f0f0f0; padding: 10px; margin-top: 10px;"> <p> IMPORTANT</p> <p>You can write notes over applications and your desktop only if SMART Product Drivers are running on your computer. If you see the  or  icon in the Windows notification area or Mac Dock, SMART Product Drivers is not running on your computer or your product is not properly connected.</p> </div>
Digital ink doesn't appear as you expect.	Check the customized pen settings in SMART Notebook software or SMART Meeting Pro software. For more information on setting digital ink properties, for example, color, line thickness, line style and transparency, refer to your SMART software's online Help.

Mac-specific issues

If you encounter issues with your Mac operating system software, refer to the following table.

Symptom	Solution
At startup, a message states that SMART Product Drivers failed to load or the interactive pen display preferences aren't created.	<ul style="list-style-type: none"> • Make sure the Power button indicator is on and the USB cable is securely connected to an active USB receptacle on your computer or to a USB hub. For details, see <i>General display issues</i> on page 1. • Connect the interactive pen display to a different USB port. Select Finder > Utilities > System Profiles > Content > Hardware > USB, and then make sure your USB pen display model is listed. Select Finder > Utilities. Start the Disk Utility program, and then run Repair Disk Permissions from the <i>First Aid</i> tab. If this doesn't resolve the problem, contact SMART Technical Support.
Handwriting Recognition doesn't work correctly.	<ul style="list-style-type: none"> • Ink preference files may be damaged. Remove the damaged Ink preference files (see <i>Removing ink preference files on Mac computers</i> on the next page).

Removing ink preference files on Mac computers

You can remove damaged ink preference files from your Mac computer to resolve some issues with handwriting recognition and digital ink.

■ To remove ink preference files from your Mac computer

1. Start your computer in Administration mode.
2. Select **Apple menu > System Preferences > Ink**, and then select **to disable handwriting recognition**.
3. Select **Finder > Home > Library > Preferences**, and then remove the following files:
 - **com.apple.ink.framework.plist**
 - **com.apple.ink.inkpad.plist**
 - **com.apple.ink.inkpad.sketch**

i NOTE

The files are automatically recreated when you enable handwriting recognition in the next step.

4. Select **Apple menu > System Preferences > Ink**, and then enable handwriting recognition. Contact Apple Support if the handwriting recognition and digital ink issues persist.

Appendix A

Adjusting video settings with the on-screen display (OSD) menu

Changing settings in the OSD menu.....	55
OSD menu settings.....	56
Display settings.....	57
Display Alignment settings.....	57
System settings.....	57

Your screen settings adjust automatically when you turn on your interactive pen display. This feature adjusts the vertical position, horizontal position and phase settings. You can also use the on-screen display (OSD) menu to adjust your screen settings. See *Changing settings in the OSD menu* below for more information.

i NOTES

- For optimal display quality, set your video card to the native resolution of your interactive pen display.
- If the interactive pen display doesn't automatically adjust your screen settings, you can use the Auto Adjust (VGA only) OSD option.

Changing settings in the OSD menu



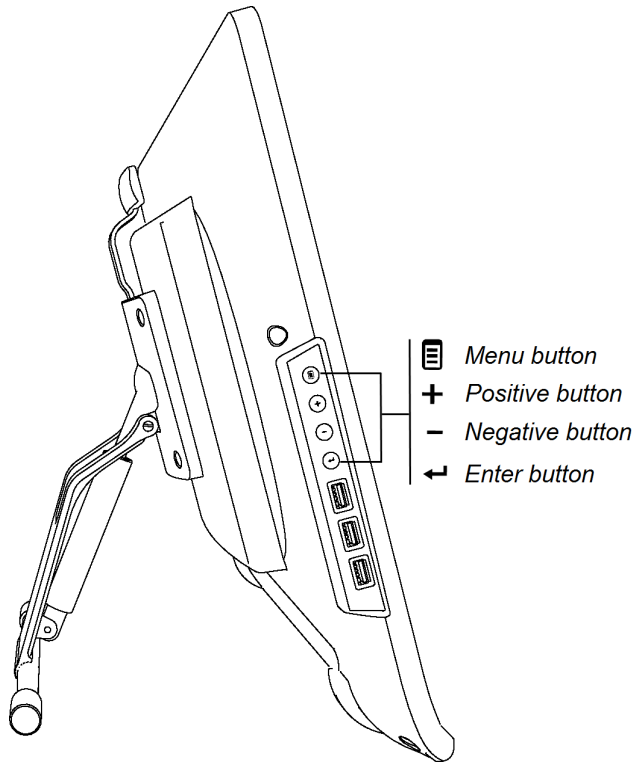

You can adjust many of the interactive pen display screen settings using the OSD menu.

APPENDIX A

Adjusting video settings with the on-screen display menu





■ To change settings in the OSD menu

1. Press **Menu**  on the control panel.
The OSD menu appears.
2. Press **+** and **-** to browse to the sub-menu that contains the setting you want to change.
3. Press **Enter**  to select the sub-menu.
4. Press **+** and **-** to browse to the setting you want to change.
5. Press **Enter**  to select the setting, and then press **Enter**  again to change the setting.

OR

Press **Enter**  to select the setting, and then press **+** to increase or **-** to decrease the value of the setting.

6. Press **Enter**  to save your changes.
7. Press **Menu**  to return to the previous screen or to exit the OSD menu.

OSD menu settings

The following tables contain the settings available through the OSD menu.

APPENDIX A

Adjusting video settings with the on-screen display menu

Display settings

Menu item	Function
Contrast	Adjusts the difference between the lightest and darkest areas of the image
Brightness	Adjusts the overall brightness of the image and background
Sharpness	Adjusts the sharpness of the image
Color Mode	Adjusts the color temperature of the entire screen

Display Alignment settings

Menu item	Function
Auto adjust	Automatically adjusts the H Position, V Position and Clock Phase settings
Horizontal	Controls the horizontal position of the image within the display area
Vertical	Controls the vertical position of the image within the display area
Clock	Adjusts the width of the image
Phase	Adjusts the visual noise on the image

System settings

Menu item	Function
Language	Selects the language used by the OSD menu
Power Save	Sets how long the interactive pen display waits to go into Power Save mode after a lost video signal
Scaling	Sets the scaling to either 1:1 or Full
Information	Selects if the Information OSD menu is displayed. This menu contains Scaling, Source and Firmware information.
Factory reset	Restores the OSD menu settings to their factory default values
OSD timeout	Sets how long the OSD menu sits idle before automatically closing

Appendix B

Hardware environmental compliance

SMART Technologies supports global efforts to ensure that electronic equipment is manufactured, sold and disposed of in a safe and environmentally friendly manner.

Waste Electrical and Electronic Equipment regulations (WEEE directive)

Waste Electrical and Electronic Equipment regulations apply to all electrical and electronic equipment sold within the European Union.

When you dispose of any electrical or electronic equipment, including SMART Technologies products, we strongly encourage you to properly recycle the electronic product when it has reached the end of its life. If you require further information, please contact your reseller or SMART Technologies for information on which recycling agency to contact.

Restriction of Certain Hazardous Substances (RoHS directive)

This product meets the requirements of the European Union's Restriction of Certain Hazardous Substances (RoHS) directive 2002/95/EC.

Consequently, this product also complies with other regulations that have arisen in various geographical areas, and that reference the European Union's RoHS directive.

Packaging

Many countries have regulations restricting the use of certain heavy metals in product packaging. The packaging used by SMART Technologies to ship products complies with applicable packaging laws.

APPENDIX B

Hardware environmental compliance

Covered electronic devices

Many U.S. states classify monitors as covered electronic devices and regulate their disposal.

Applicable SMART Technologies products meet the requirements of the covered electronic devices regulations.

China's Electronic Information Products regulations

China regulates products that are classified as EIP (Electronic Information Products).

SMART Technologies products fall under this classification and meet the requirements for China's EIP regulations.

SMART Technologies

smarttech.com/support

smarttech.com/contactsupport