



# SMART Notebook™ 11.4

Mac OS X operating system software

**User's guide**

Scan the following QR code to view the SMART Notebook software Help on your smart phone or other mobile device.



**SMART®**

**Trademark notice**

SMART Notebook, SMART Document Camera, SMART Ink, SMART Board, SMART Response, SMART Exchange, smarttech, the SMART logo and all SMART taglines are trademarks or registered trademarks of SMART Technologies ULC in the U.S. and/or other countries. Mac, Mac OS, OS X, Finder and QuickTime are trademarks of Apple Inc., registered in the U.S. and other countries. Windows and PowerPoint are either registered trademarks or trademarks of Microsoft Corporation in the U.S. and/or other countries. Adobe and Flash are either registered trademarks or trademarks of Adobe Systems Incorporated in the U.S. and/or other countries. All other third-party product and company names may be trademarks of their respective owners.

**Copyright notice**

© 2013 SMART Technologies ULC. All rights reserved. No part of this publication may be reproduced, transmitted, transcribed, stored in a retrieval system or translated into any language in any form by any means without the prior written consent of SMART Technologies ULC. Information in this manual is subject to change without notice and does not represent a commitment on the part of SMART.

This product and/or use thereof covered by one or more of the following U.S. patents.

[www.smarttech.com/patents](http://www.smarttech.com/patents)

12/2013

# Contents

<b>Chapter 1: Getting started with SMART Notebook software</b> .....	<b>1</b>
About SMART Notebook software .....	2
About the other SMART software on your computer .....	2
Starting SMART Notebook software .....	3
Navigating the user interface .....	3
Using gestures .....	8
Undoing and redoing actions .....	10
<b>Chapter 2: Creating and working with files</b> .....	<b>11</b>
Creating files .....	11
Opening files .....	11
Saving files .....	12
Exporting files .....	13
Printing files .....	15
<b>Chapter 3: Creating and working with pages</b> .....	<b>17</b>
Displaying pages in a file .....	17
Creating pages .....	18
Cloning pages .....	19
Extending pages .....	19
Renaming pages .....	20
Rearranging pages .....	20
Grouping pages .....	21
Deleting pages .....	22
<b>Chapter 4: Creating basic objects</b> .....	<b>25</b>
Writing, drawing and erasing digital ink .....	26
Creating shapes and lines .....	29
Creating text .....	32
Creating tables .....	39
<b>Chapter 5: Working with objects</b> .....	<b>49</b>
Selecting objects .....	50
Changing objects' properties .....	52
Positioning objects .....	55
Cutting, copying and pasting objects .....	59
Cloning objects .....	60
Resizing objects .....	61

## CONTENTS

Rotating objects .....	63
Flipping objects .....	65
Grouping objects .....	65
Deleting objects .....	67
<b>Chapter 6: Inserting, organizing and sharing content .....</b>	<b>69</b>
Inserting content from the Gallery .....	70
Inserting content from the SMART Exchange website .....	72
Inserting content from other sources .....	72
Inserting Internet browsers .....	78
Attaching files and web pages .....	80
Organizing and sharing content using the Gallery .....	81
Sharing content using the SMART Exchange website .....	86
<b>Chapter 7: Creating lesson activities .....</b>	<b>89</b>
Using advanced object features .....	90
Using advanced page features .....	97
Creating example lesson activities .....	101
<b>Chapter 8: Presenting lesson activities and facilitating collaboration .....</b>	<b>109</b>
Preparing before presenting .....	110
Using presentation tools while presenting .....	118
Clearing or resetting pages after presenting .....	131
Enabling two people to use an interactive whiteboard .....	134
<b>Chapter 9: Enhancing SMART Notebook software with add-ons .....</b>	<b>137</b>
Installing add-ons .....	137
Using add-ons .....	138
Identifying missing add-ons .....	138
Disabling and removing add-ons .....	139
<b>Chapter 10: Maintaining SMART Notebook software .....</b>	<b>141</b>
Customizing the toolbar .....	141
Configuring SMART Notebook software .....	143
Setting the language .....	150
Removing SMART software .....	150
Updating and activating SMART software .....	151
Sending feedback to SMART .....	155
<b>Chapter 11: Troubleshooting SMART Notebook software .....</b>	<b>157</b>
Troubleshooting files .....	157
Troubleshooting the SMART Notebook software window and toolbar .....	157
Troubleshooting digital ink .....	158
Troubleshooting objects .....	159
Troubleshooting gestures .....	160

**C O N T E N T S**

**Index** ..... **161**



# Chapter 1

## Getting started with SMART Notebook software

About SMART Notebook software .....	2
About the other SMART software on your computer .....	2
Starting SMART Notebook software .....	3
Navigating the user interface .....	3
Menu .....	3
Toolbar .....	3
Actions panel .....	4
Plug-ins panel .....	4
Tools panel .....	4
Contextual panel .....	4
Customizing the toolbar .....	5
Page Sorter .....	5
Opening the Page Sorter .....	5
Customizing the Page Sorter .....	5
Gallery tab .....	6
Opening the Gallery tab .....	6
Customizing the Gallery tab .....	6
Attachments tab .....	6
Opening the Attachments tab .....	6
Customizing the Attachments tab .....	6
Properties tab .....	7
Opening the Properties tab .....	7
Customizing the Properties tab .....	7
Add-ons tab .....	7
Opening the Add-ons tab .....	7
Customizing the Add-ons tab .....	7
SMART Response tab .....	8
Page area .....	8
Using gestures .....	8
Undoing and redoing actions .....	10

---

## CHAPTER 1

Getting started with SMART Notebook software

This chapter introduces you to SMART Notebook™ collaborative learning software and explains how to get started with the software.

### About SMART Notebook software

In SMART Notebook software, you can create .notebook files that include graphics, text, tables, lines, shapes, animations and more. Present your file and keep your class's attention as you move and interact with these objects. When your class provides comments and suggestions, write their input on the page using digital ink. You can open .notebook files in SMART Notebook software on a Windows®, Mac or Linux® computer. You can also export your file in a variety of formats, including HTML and PDF.

You can install SMART Notebook Tools as well as third-party add-ons to add special features to SMART Notebook software. SMART Notebook Tools include the following:

- 3D Tools for SMART Notebook software
- Mixed Reality Tools for SMART Document Camera™

### About the other SMART software on your computer

Your computer might include the following other SMART software.

- **SMART Product Drivers**

Your interactive product detects contact with its screen and sends each contact point, along with Pen tool information, to the connected computer. SMART Product Drivers translates the information into mouse clicks and digital ink. SMART Product Drivers enables you to perform normal computer operations by using your finger or a pen.

- **SMART Ink™**

Using SMART Ink, you can write or draw on the screen in digital ink using a pen, and then save or erase your notes.

- **SMART Board® Tools**

You can draw attention to specific parts of a page using SMART Board Tools, such as the Screen Shade, Spotlight, Magnifier and Pointer.



## Starting SMART Notebook software

Start SMART Notebook software by pressing **Notebook** in the Dock.

### NOTE

If your computer's display refresh rate is less than 60 Hz, a warning message appears when you first start SMART Notebook software. You can change the display refresh rate by opening **System Preferences > Displays** in Mac OS X operating system software.

When you start SMART Notebook software the first time, a tutorial file opens automatically. You can read the contents of this file to learn more about the software and the new features in the latest release. When you're done, select **File > New** to create a new, blank file.

### NOTE

When you start the software subsequent times, a new, blank file opens automatically. To open the tutorial file, select **Help > Tutorial**.

## Navigating the user interface

The SMART Notebook software user interface consists of the following components:

- Menu
- Toolbar
- Tabs (Page Sorter, Gallery, Attachments, Properties, Add-ons and SMART Response™)
- Page area

### Menu

The menu contains all the commands you can use to manipulate files and objects in SMART Notebook software.

### Toolbar

The toolbar enables you to select and use a variety of commands. The buttons on the toolbar are organized in panels.

### NOTE

The commands in the toolbar are also accessible from the menu (see *Menu* above).

## CHAPTER 1

Getting started with SMART Notebook software

### Actions panel

The *Actions* panel of the toolbar includes buttons that enable you to browse and make changes to .notebook files:



### Plug-ins panel

If you install SMART Notebook Tools, such as SMART Response software, or third-party plug-ins, an additional panel appears to the right of the *Actions* panel:



### Tools panel

The *Tools* panel includes buttons that enable you to create and work with basic objects on pages:



### Contextual panel

When you select one of the buttons in the *Tools* panel, additional buttons appear. For example, if you select **Pens** , the following additional buttons appear:

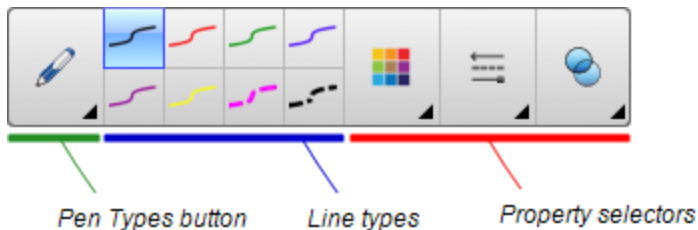

Press the **Pen Types** button to select a pen type and then press one of the line type buttons to write or draw digital ink in that line type. You can customize a selected line type using the options in the Properties tab and then save your changes for future use (see *Saving tool settings* on page 55).

The three property selectors beside the line type buttons enable you to set the color, thickness, style and transparency of digital ink.

If you click any of the other buttons in the *Tools* panel, similar sets of additional buttons appear.

## CHAPTER 1

Getting started with SMART Notebook software

### Customizing the toolbar

You can add, remove and change the position of buttons on the toolbar by pressing **Customize the toolbar**  (see *Customizing the toolbar* on page 141).

By default, the toolbar appears at the top of the SMART Notebook software window. However, you can move it to the bottom of the window by pressing **Move toolbar to top/bottom of window** . This is useful in situations where you or your students can't reach the toolbar when it's at the top of the window.

## Page Sorter

The Page Sorter displays all of the pages in the open file as thumbnails and automatically updates these thumbnails as you change the contents of the pages.

Using the Page Sorter, you can do the following:

- Display pages
- Create pages
- Clone pages
- Clear pages
- Delete pages
- Rename pages
- Rearrange pages
- Move objects from one page to another
- Group pages

### Opening the Page Sorter

To open the Page Sorter, press **Page Sorter** .

### Customizing the Page Sorter

You can move the Page Sorter from one side of the SMART Notebook software window to the other by pressing **Move Sidebar** .

You can resize the Page Sorter by dragging its border left or right. You can also hide the Page Sorter when you aren't using it by selecting the **Auto-hide** check box. (To display the Page Sorter when it's hidden, press **Page Sorter** .)



#### NOTE

If you reduce the Page Sorter to its minimum size, the auto-hide feature turns on automatically.

## CHAPTER 1

Getting started with SMART Notebook software

### Gallery tab

The Gallery tab contains clip art, backgrounds, multimedia content, files and pages that you can use in your lessons, and displays preview images of this content. The Gallery tab also provides access to other online resources. For more information, see *Inserting content from the Gallery* on page 70.

You can also include your own content and content from other teachers in your school in the Gallery tab (see *Organizing and sharing content using the Gallery* on page 81).

#### Opening the Gallery tab

To open the Gallery tab, press **Gallery** .

#### Customizing the Gallery tab

You can move the Gallery tab from one side of the SMART Notebook software window to the other by pressing **Move Sidebar** .

You can resize the Gallery tab by dragging its border left or right. You can also hide the Gallery tab when you aren't using it by selecting the **Auto-hide** check box. (To display the Gallery tab when it's hidden, press **Gallery** .)

#### NOTE

If you reduce the Gallery tab to its minimum size, the auto-hide feature turns on automatically.

### Attachments tab

The Attachments tab displays the files and web pages attached to the current file. For more information, see *Attaching files and web pages* on page 80.

#### Opening the Attachments tab

To open the Attachments tab, press **Attachments** .

#### Customizing the Attachments tab

You can move the Attachments tab from one side of the SMART Notebook software window to the other by pressing **Move Sidebar** .

You can resize the Attachments tab by dragging its border left or right. You can also hide the Attachments tab when you aren't using it by selecting the **Auto-hide** check box. (To display the Attachments tab when it's hidden, press **Attachments** .)

#### NOTE

If you reduce the Attachments tab to its minimum size, the auto-hide feature turns on automatically.

## CHAPTER 1

Getting started with SMART Notebook software

### Properties tab

The Properties tab enables you to format objects on a page, including digital ink, shapes, lines, text and tables. Depending on the object you select, you can change the following:

- The color, thickness and style of lines
- The transparency and fill effects of objects
- The font type, size and style of text
- The animation of objects

The Properties tab displays only the options that are available for the object you select. For more information on displaying and setting object properties in the Properties tab, see *Changing objects' properties* on page 52.

The Properties tab also includes a **Page Recording** button. You can use this feature to record your actions on the current page (see *Recording pages* on page 97).

#### Opening the Properties tab

To open the Properties tab, press **Properties** .

#### Customizing the Properties tab

You can move the Properties tab from one side of the SMART Notebook software window to the other by pressing **Move Sidebar** .

You can resize the Properties tab by dragging its border left or right. You can also hide the Properties tab when you aren't using it by selecting the **Auto-hide** check box. (To display the Properties tab when it's hidden, press **Properties** )

#### NOTE

If you reduce the Properties tab to its minimum size, the auto-hide feature turns on automatically.

### Add-ons tab

The Add-ons tab enables you to work with SMART Notebook software add-ons (see *Enhancing SMART Notebook software with add-ons* on page 137).

#### Opening the Add-ons tab

To open the Add-ons tab, press **Add-ons** .

#### Customizing the Add-ons tab

You can move the Add-ons tab from one side of the SMART Notebook software window to the other by pressing **Move Sidebar** .

## CHAPTER 1

Getting started with SMART Notebook software

You can resize the Add-ons tab by dragging its border left or right. You can also hide the Add-ons tab when you aren't using it by selecting the **Auto-hide** check box. (To display the Add-ons tab when it's hidden, press **Add-ons** )

### NOTE

If you reduce the Add-ons tab to its minimum size, the auto-hide feature turns on automatically.

## SMART Response tab

The SMART Response tab is part of SMART Response software and is available only if you have SMART Response software installed.

## Page area

The page area displays the contents of a selected page in a file. This is the area of the page where you create and work with objects (see *Creating basic objects* on page 25).

## Using gestures

You can interact with objects in SMART Notebook software using the following gestures (if supported by your interactive product):

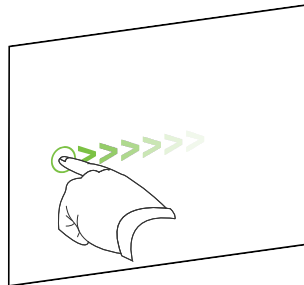

Swipe (left to right)

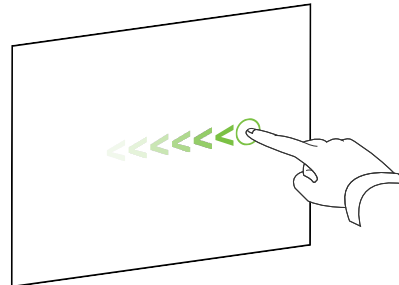

Swipe (right to left)

**CHAPTER 1**

Getting started with SMART Notebook software

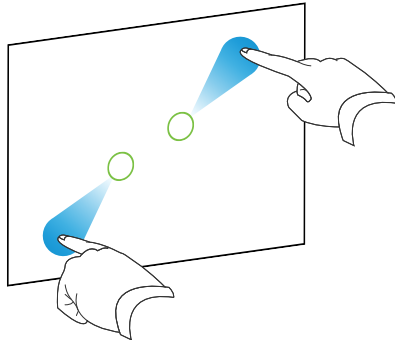

Pinch to zoom in / scale (enlarge)

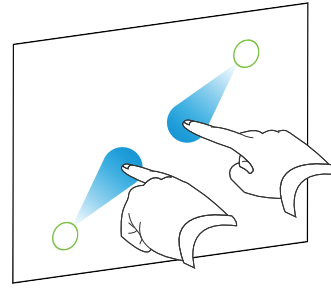

Pinch to zoom out / scale (reduce)

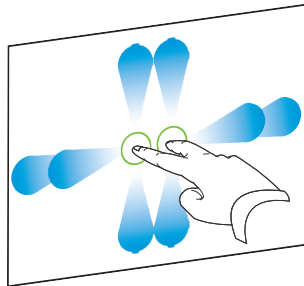

Pan

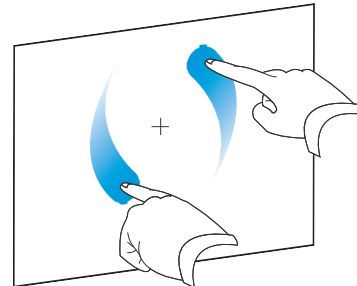

Rotate

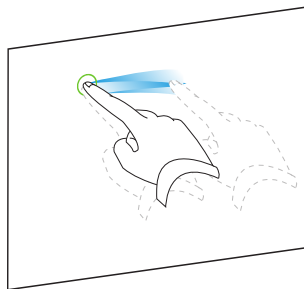

Shake

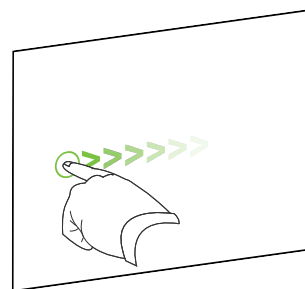

Flick

## Undoing and redoing actions

When you make changes to a file, you can reverse the effects of your previous actions and commands.

 **NOTE**

If two people are using your interactive product, pressing **Undo** and **Redo** affects the actions of both users.

 **To reverse the effect of the last action**

Press **Undo** .

 **NOTE**

You can undo an unlimited number of actions.

 **To reinstate the last action reversed with the Undo command**

Press **Redo** .



## Chapter 2

# Creating and working with files

Creating files .....	11
Opening files .....	11
Saving files .....	12
Exporting files .....	13
Printing files .....	15

---

In SMART Notebook software, you can create or open SMART Notebook software (.notebook) files. After creating or opening a .notebook file, you can save it, print it and complete other common tasks.

## Creating files

When you start SMART Notebook software for the first time, a tutorial file opens automatically. When you start the software subsequent times, a new .notebook file opens automatically. However, you can create a new file at any time.

### To create a file

Select **File > New**.

## Opening files

With SMART Notebook 11 software, you can open the following:

- .notebook files (the default file format for SMART Notebook 9.5, 9.7, 10 and 11 software)
- .xbk files (the default file format for SMART Notebook 8.x, 9.0 and 9.1 software)

After you open a file, you can save the file as a .notebook file.

The method by which you open a file is the same for all versions of SMART Notebook software.

## CHAPTER 2

Creating and working with files

### To open a file

1. Press **Open File** .  
The *Open* dialog box appears.
2. Browse to and select the file.
3. Press **Open**.

#### TIP

You can open a recently opened file by selecting **File > Open Recent**, and then selecting the file name.

## Saving files

By default, SMART Notebook software saves your files in .notebook format. Anyone with SMART Notebook 9.5 or later software for Windows operating systems, Mac OS X operating system software or Linux operating systems installed on his or her computer can open a .notebook file.

### To save a new file

1. Press **Save** .  
A dialog box appears.
2. Browse to where you want to save the new file.
3. Type a name for the file in the *Save As* box.
4. Press **Save**.

### To save an existing file

Press **Save** .

### To save an existing file with a new name or location

1. Select **File > Save As**.  
A dialog box appears.
2. Browse to where you want to save the new file.
3. Type a name for the file in the *Save As* box.
4. Press **Save**.

### To save all open files

Select **File > Save All**.

## Exporting files

You can export your .notebook files to the following formats:

- Web pages
- Picture formats
  - BMP
  - JPEG
  - PNG
  - TIFF
- PDF
- Interactive Whiteboard Common File Format (CFF)



### NOTES

- SMART Notebook software doesn't include links when you export files as web pages, picture files or PDF.
- SMART Notebook software doesn't include attachments when you export files as picture files or PDF. To include attachments, you must export your file as web pages.
- SMART Notebook software doesn't export files that you attach to your .notebook file as aliases. If you want to include an attachment, attach a copy of the file (see *Attaching files and web pages* on page 80).
- SMART Notebook software doesn't export some gradient, pattern and image effects. These effects might appear as a solid fill or appear incorrectly in the exported file.

### To export a file as web pages

1. Select **File > Export As > Web Page**.  
A dialog box appears.
2. Browse to where you want to export the file.
3. Type a name for the file in the *Save As* box.
4. Press **Save**.

## CHAPTER 2

Creating and working with files

### To export a file as picture files

1. Select **File > Export As > Image Files**.  
A dialog box appears.
2. Select a folder where you want to export the files.
3. Select a picture format in the *Image Format* drop-down list.
4. Select a picture size in the *Image Size* drop-down list.
5. Type a name for the files in the *Save As* box.
6. Press **Save**.

### To export a file as a PDF file

1. Select **File > Export As > PDF**.  
A dialog box appears.
2. Press **Thumbnails, Handouts** or **Full Page**.
3. Optionally, type header text in the *Header* box, footer text in the *Footer* box and the current date in the *Date* box.
4. Optionally, select the **Show page borders** check box to show a border around each printed page.
5. Optionally, select the **Show page numbers** check box to show a page number on each page.
6. If you pressed **Thumbnails** or **Handouts** in step 2, select a thumbnail size in the *Thumbnail Size* drop-down list and, optionally, select the **Show Thumbnail titles** check box to show titles under each thumbnail.
7. Press **Continue**.  
The *Save* dialog box appears.
8. Browse to where you want to export the file.
9. Type a name for the file in the *Save As* box.
10. Press **Save**.

### To export a file as a CFF file

1. Select **File > Export As > CFF**.  
A dialog box appears.
2. Browse to where you want to export the file.

## CHAPTER 2

Creating and working with files

3. Type a name for the file in the *Save As* box.
4. Press **Save**.



### NOTE

You can also import CFF files (see *Importing files from other interactive whiteboard programs* on page 78).

## Printing files

You can print all pages or select pages in a .notebook file. You can print the pages as thumbnails, handouts or full pages.

### To print a file

1. Select **File > Print**.  
A dialog box appears.
2. Press **Thumbnails**, **Handouts** or **Full Page**.
3. Optionally, type header text in the *Header* box, footer text in the *Footer* box and the current date in the *Date* box.
4. Optionally, select the **Show page borders** check box to show a border around each printed page.
5. Optionally, select the **Show page numbers** check box to show a page number on each page.
6. If you pressed **Thumbnails** or **Handouts** in step 2, select a thumbnail size in the *Thumbnail Size* drop-down list and, optionally, select the **Show Thumbnail titles** check box to show titles under each thumbnail.
7. Press **Continue**.  
A dialog box appears.
8. If all print settings aren't visible, press the disclosure triangle beside the *Printer* drop-down list.
9. Select **All** to include all pages.  
OR  
Select **From** to include select pages, and then type the page range.
10. Select other print settings, including the printer name and the number of copies.
11. Press **Print**.



## Chapter 3

# Creating and working with pages

Displaying pages in a file .....	17
Creating pages .....	18
Cloning pages .....	19
Extending pages .....	19
Renaming pages .....	20
Rearranging pages .....	20
Grouping pages .....	21
Deleting pages .....	22

---

A .notebook file is composed of a series of pages, each with its own objects and properties.

A thumbnail of each page appears in the Page Sorter. Using either the Page Sorter or menu commands, you can display an existing page, create a blank page, create a clone of an existing page or delete an existing page.

## Displaying pages in a file

You can display any page in the file using the Page Sorter. You can display the next or previous page in the file using buttons or gestures.

### ■ To display a page

1. If the Page Sorter isn't visible, press **Page Sorter** .
2. Press the thumbnail of the page you want to display.

### ■ To display the next page in a file

Press **Next Page** .

OR

Swipe your finger across the page from right to left.

## CHAPTER 3

Creating and working with pages

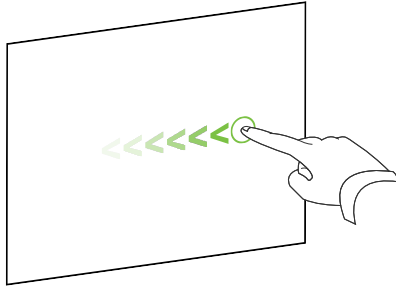

A message appears, displaying the current page's number.

2

### ■ To display the previous page in a file

Press **Previous Page** .

OR

Swipe your finger across the page from left to right.

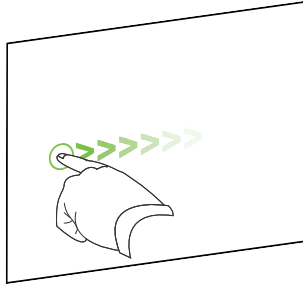

A message appears, displaying the current page's number.

2

## Creating pages

You can add a blank page to the open file using the *Add Page* button or the Page Sorter.

### ■ To insert a page using the Add Page button

Press **Add Page** .

The new page appears after the current page.



### To insert a page using the Page Sorter

1. If the Page Sorter isn't visible, press **Page Sorter** .
2. Select the thumbnail of the page you want the new page to appear after.
3. Press the thumbnail's menu arrow, and then select **Insert Blank Page**.

The new page appears after the selected page.

## Cloning pages

As an alternative to creating a blank page, you can create a duplicate (or “clone”) of an existing page.

### NOTE

You can clone a page only if it contains content.

### To clone a page

1. If the Page Sorter isn't visible, press **Page Sorter** .
2. Select the thumbnail of the page you want to clone.
3. Press the thumbnail's menu arrow, and then select **Clone Page**.

The cloned page appears immediately after the current page.

### NOTE

You can repeat this process as many times as you want.

## Extending pages

If you need more room at the bottom of a page, you can extend the page vertically without affecting the page's width. You can turn this feature off to prevent your pages from becoming longer.

### To extend a page

1. If you're displaying the page in Entire Page view, select a different zoom level.
2. Press the **Extend Page** link at the bottom of the page.

## CHAPTER 3

Creating and working with pages

### ■ To turn Extend Page on or off

1. Select **View > Extend Page**
2. Select **Off** to turn the Extend Page feature off.

OR

Select **On** to turn the Extend Page feature on.

## Renaming pages

When you create a page, SMART Notebook software automatically names the page with the date and time of its creation. You can change this name.

### ■ To rename a page

1. If the Page Sorter isn't visible, press **Page Sorter** .
2. Double-click the page's name.
3. Type a new name for the page.
4. Press elsewhere.

## Rearranging pages

If you want, you can rearrange the order of the pages in a file.

### ■ To rearrange pages

1. If the Page Sorter isn't visible, press **Page Sorter** .
2. Press the thumbnail of the page you want to move in the file.  
A blue border appears around the thumbnail.
3. Drag the thumbnail to its new position in the Page Sorter.  
A blue line indicates the page's new position.
4. Release the thumbnail.

## Grouping pages

You can group pages in a file. This enables you to find a particular group quickly in the Page Sorter, and then display its pages. This is useful when there are a lot of pages in a file.

### To create or edit a group

1. If the Page Sorter isn't visible, press **Page Sorter** .
2. Press the first group's menu arrow, and then select **Edit Page Groups**.

All the groups and pages for the current file are displayed. Groups appear as blue bars and pages appear as thumbnails:

- If you created and edited the groups in this file, the pages appear under the blue bars you created and renamed.
- If you haven't edited the groups, a default group titled *Group 1* appears and includes all of the pages and their thumbnails below its blue bar.



#### NOTE

Thumbnails below each blue bar include the same menu arrow options as thumbnails in the Page Sorter. This enables you to press a thumbnail in a group, select its menu arrow, and then delete the page, clear the page, insert a new page, clone the page, rename the page, add a Screen Shade to the page or add the page to the Gallery.

3. Press the **Add New Group** button in the upper-right corner.  
A new group, with a new, blank page, appears.
4. Type a new name for the group.

## CHAPTER 3

Creating and working with pages

5. Do the following:

- To move a page into a group, press the page's thumbnail, and then drag it below the group's blue bar and to the right of the thumbnail you want it to follow.
- To rearrange the order of pages in a group, press a page's thumbnail, and then drag it to the right of the thumbnail you want it to follow.
- To rearrange the order of groups, press a group's blue bar, and then drag it below the blue bar of the group you want it to follow.

### NOTES

- You can also change the order of the groups by pressing a blue bar's menu arrow, and then selecting **Move Up** or **Move Down**.
  - SMART Notebook software numbers pages sequentially across a file. If you change the order of groups, SMART Notebook software rennumbers the pages in the groups accordingly.
- To delete a group and keep its pages, move all of its pages to different groups. When a group contains no pages, SMART Notebook software automatically deletes it.
  - To delete a group and all pages in the group, press the blue bar's menu arrow, and then select **Delete Group**.

6. Press .

### To access a group in the Page Sorter

1. If the Page Sorter isn't visible, press **Page Sorter** .
2. Press the first group's menu arrow, and then select the name of the group you want to access.

The Page Sorter displays the thumbnail for the first page in the group you want to access.

## Deleting pages

You can delete a page from the current file using the *Delete Page* button or the Page Sorter.

### TIP

As an alternative to deleting a page, you can clear all of its objects (see *Clearing pages* on page 132).

## CHAPTER 3

Creating and working with pages

### ■ To delete a page using the Delete Page button

1. If you haven't done so already, display the page you want to delete.
2. Select **Delete Page** .

### ■ To delete a page using the Page Sorter

1. If the Page Sorter isn't visible, press **Page Sorter** .
2. Select the thumbnail of the page you want to delete.
3. Press the thumbnail's menu arrow, and then select **Delete Page**.



# Chapter 4

## Creating basic objects

Writing, drawing and erasing digital ink .....	26
Writing or drawing digital ink .....	26
Erasing digital ink .....	28
Creating shapes and lines .....	29
Creating shapes with the Shapes tool .....	29
Creating shapes with the Regular Polygons tool .....	30
Creating shapes with the Shape Recognition Pen tool .....	31
Creating straight lines and arcs .....	32
Creating text .....	32
Typing text .....	33
Converting handwriting to typed text .....	33
Formatting text .....	34
Resizing text objects .....	36
Inserting mathematical symbols .....	37
Checking the spelling of text objects .....	37
Cutting and pasting text .....	38
Creating tables .....	39
Creating tables .....	39
Pasting tables from other programs .....	41
Adding objects to tables .....	41
Selecting tables, columns, rows or cells .....	42
Moving tables .....	43
Changing a table's properties .....	43
Resizing tables, columns or rows .....	45
Adding or removing columns, rows or cells .....	46
Splitting or merging table cells .....	47
Deleting tables and the contents of tables .....	48

---

Objects are the building blocks of content in your .notebook files. An object is simply an item on a page that you create or import and then work with. Basic types of objects include the following:

- Digital ink (freehand writing and drawing)
- Shapes

## CHAPTER 4

### Creating basic objects

- Straight lines
- Arcs
- Text
- Tables

## Writing, drawing and erasing digital ink





Digital ink is freehand text or objects that you create using your interactive display's pen or pens, or the SMART Notebook software Pens tool. Writing or drawing digital ink enables you to quickly add content to your SMART Notebook software files, either when creating the files or when presenting the files to students.

After you create digital ink, you can erase it.

### Writing or drawing digital ink

The easiest way to write or draw digital ink is to use your interactive display's pen or pens.



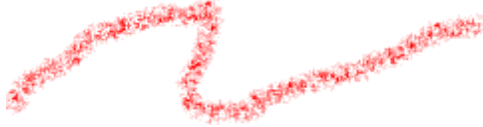

You can also create freehand objects using the Pens tool. The Pens tool enables you to write or draw digital ink using the following pen types:

Pen type	Purpose and example	Notes
 Standard	Write or draw digital ink in a variety of colors and line styles. 	Using the Standard pen type, you can write or draw digital ink that fades after a few seconds (see <i>Using the Standard pen type to create fading objects</i> on page 123).
 Calligraphic	Write or draw digital ink, like you do with the Standard pen type, but with lines of varying thickness. 	The Calligraphic pen type is useful for teaching students handwriting. The Calligraphic pen type is available only if your computer is connected to a SMART interactive product.
 Crayon	Write or draw crayon-like digital ink. 	The Crayon pen type is intended for artistic work such as painting, coloring pictures and so on rather than writing.

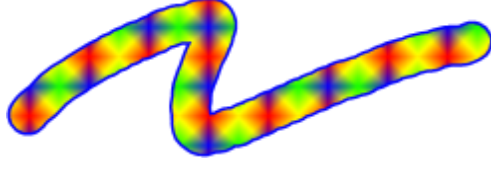

## CHAPTER 4

### Creating basic objects

Pen type	Purpose and example	Notes
 Highlighter	Highlight text and other objects. 	
 Creative	Add colorful elements to your presentations. 	You can create custom Creative pen styles (see <i>Creating custom Creative pen styles</i> on page 90).
 Magic	Write or draw digital ink that fades after a few seconds.	You can also use the Magic Pen to open a magnification window or a spotlight window (see <i>Using the Magic Pen</i> on page 119).
 Shape Recognition	Draw a variety of shapes with digital ink.	You can draw circles, ovals, squares, rectangles, triangles and arcs (see <i>Creating shapes with the Shape Recognition Pen tool</i> on page 31).

### To write or draw digital ink

1. Press **Pens** .

The Pens tool buttons appear.

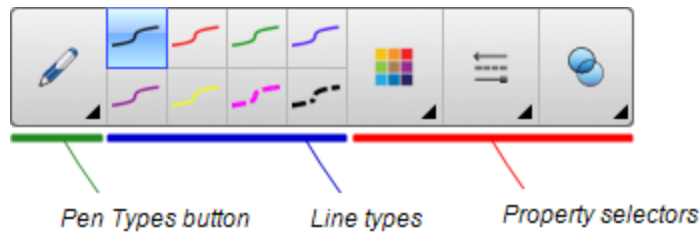

2. Press **Pen Types**, and then select a pen type.
3. Select a line type.

## CHAPTER 4

### Creating basic objects

4. Optionally, customize the line type using the property selectors.

#### NOTE

You can also customize the line type using the Properties tab (see *Changing objects' properties* on page 52).

5. Write or draw digital ink on the page.

#### TIPS

- Don't rest your elbow or the palm of your hand on your interactive product's surface while you write or draw.
- If you write or draw multiple lines, SMART Notebook software automatically combines the lines into a single object. For example, if you write the letters of a word, SMART Notebook software combines the individual letters, enabling you to interact with the whole word. If you want to write words on the same line but don't want them combined, leave a large gap between them, use different pens, or briefly put the pen in the pen tray before writing another word (interactive whiteboards only).
- If you want to write diagonally, write in a straight line, and then rotate it (see *Rotating objects* on page 63).
- If you want to write in small letters, write large letters, and then reduce their size (see *Resizing objects* on page 61).
- You can fill areas that you've enclosed with digital ink (see *Filling digital ink drawings* on page 54).

## Erasing digital ink

You can erase digital ink from your interactive display using the eraser or the erasing gesture. If you're erasing digital ink from a .notebook file page, you can also erase objects using the Eraser tool.

#### NOTE

Although you can erase digital ink, you're unable to erase other types of objects, including shapes, lines, text and pictures. To remove these types of objects, you must delete them (see *Deleting objects* on page 67).

### To erase digital ink

1. Press **Eraser** , and then select an eraser type.
2. Erase the digital ink.

## Creating shapes and lines

In addition to creating freehand shapes and lines by drawing digital ink, you can create shapes and lines using the tools in SMART Notebook software.

### NOTE

To remove a shape or line from a page, you must delete it (see *Deleting objects* on page 67). The Eraser tool doesn't remove shapes.

### Creating shapes with the Shapes tool

You can use the Shapes tool to create a variety of shapes, including perfect circles, perfect squares, perfect triangles, other geometric shapes, hearts, check marks and Xs.

You can add a shape to your page, and then edit its properties. Alternatively, you can customize a shape's outline color, fill color and line thickness, and then add it to your page.

#### To create a shape

1. Press **Shapes** .

The Shapes tool buttons appear.



2. Select a shape on the toolbar.  
OR  
Press ▼ and then select a shape.
3. Optionally, customize the shape using the property selectors.

### NOTE

You can also customize the shape using the Properties tab (see *Changing objects' properties* on page 52).



## CHAPTER 4

### Creating basic objects

4. Create a shape by pressing where you want to place the shape and dragging until the shape is the size you want.



#### TIP

- You can create perfect circles, squares, triangles and other shapes by holding down SHIFT as you draw the shape.
- You can select a shape while the **Shapes** tool  is active without having to switch to the **Select** tool . Press the shape once, and a selection rectangle appears around the shape.

## Creating shapes with the Regular Polygons tool

In addition to creating shapes using the Shapes tool, you can create regular polygons with 3 to 15 sides using the Regular Polygons tool.

### To create a shape with the Regular Polygons tool

1. Press **Regular Polygons** .

The Regular Polygons tool buttons appear.

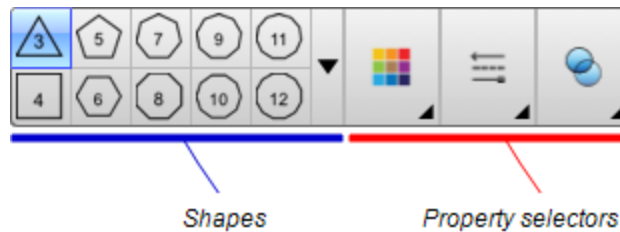

2. Select a shape on the toolbar.

OR

Press ▼ and then select a shape.



#### NOTE

The number in the shape indicates its number of sides.

3. Optionally, customize the shape using the property selectors.



#### NOTE

You can also customize the shape using the Properties tab (see *Changing objects' properties* on page 52).

## CHAPTER 4

### Creating basic objects

4. Create a shape by pressing where you want to place the shape and dragging until the shape is the size you want.

## Creating shapes with the Shape Recognition Pen tool

You can use the Shape Recognition Pen tool to draw circles, ovals, squares, rectangles, triangles and arcs.

### NOTE

You can also create shapes using the Shapes tool (see *Creating shapes with the Shapes tool* on page 29) or the Regular Polygons tool (see *Creating shapes with the Regular Polygons tool* on the previous page).

### To draw a shape

1. Press **Pens** .

The Pens tool buttons appear.

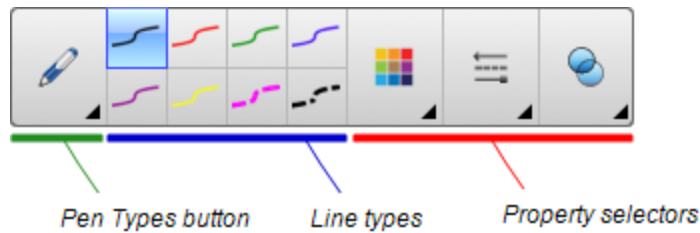

2. Press **Pen Types**, and then select **Shape Recognition Pen**.
3. Draw a shape on the page.

If SMART Notebook software recognizes your drawing as a circle, oval, square, rectangle, triangle or arc, it adds this shape to the page.



## Creating straight lines and arcs

You can use the Lines tool to draw straight lines and arcs.

You can add a line to your page, and then edit its properties. Alternatively, you can customize the line, and then add it to your page.

### To create a straight line or arc

1. Press **Lines** .

The Lines tool buttons appear.

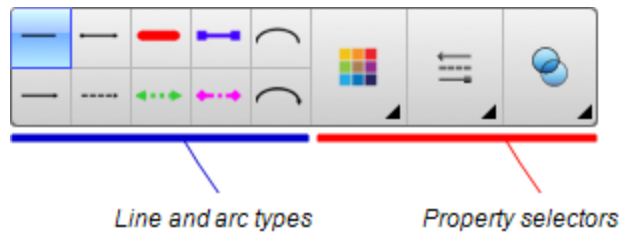

2. Select a line or arc type.
3. Optionally, customize the line or arc type using the property selectors.



#### NOTE

You can also customize the line or arc type using the Properties tab (see *Changing objects' properties* on page 52).

4. Create a line by pressing where you want the line to start and dragging to where you want the line to end.

## Creating text

You can create text in SMART Notebook software by doing any of the following:



- Typing the text using a keyboard connected to your computer
- Typing the text using SMART Keyboard
- Writing the text (see *Writing, drawing and erasing digital ink* on page 26) and then converting it to typed text using the software's handwriting recognition feature

After creating text, you can edit it, check its spelling and change its properties, including font style, size and color.

## Typing text

You can type new text or edit existing text.

### To type new text

1. If a keyboard isn't accessible, press and hold **SMART Board Tools**  in the Dock, and then select **Keyboard**.
2. Press **Text** , and then select an available font style.
3. Optionally, customize the font style (see *Formatting text* on the next page).
4. Press where you want the text to start.
5. Type your text.
6. When you're done, press outside the text object.

### To edit existing text

1. Double-click the text object.
2. Edit the text.
3. When you're done, press outside the text object.

## Converting handwriting to typed text

You can write on your interactive product's screen using the Standard or Calligraphic pen types and convert your writing to typed text. SMART Notebook software can convert handwriting in multiple languages.

### To convert handwriting to typed text

1. Press **Pens** .

The Pens tool buttons appear.

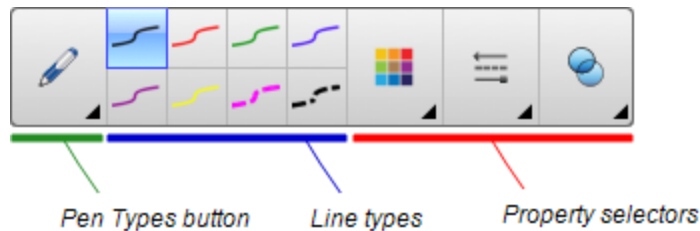

2. Press **Pen Types**, and then select **Pen** or **Calligraphic Pen**.

## CHAPTER 4

### Creating basic objects

3. Write your text.

#### TIP

Write tidy, printed characters on a horizontal line. Although SMART Notebook software can convert slanted or cursive writing, it doesn't always do so consistently.

4. Select the text object.

The SMART Notebook software handwriting recognition feature compares your written word with its dictionary and identifies words that most resemble what you've written.

5. Press the text object's menu arrow.

A menu appears and displays the list of matching words, each preceded by *Recognize*.

#### NOTES

- If you want SMART Notebook software to identify words in a different language, select **Recognize Languages**, and then select another language in the list. SMART Notebook software updates the list of matching words to include words in the selected language.
- If you change the handwriting recognition language, you don't change the default language of the SMART Notebook software user interface or your operating system.

6. Select a word in the list of matching words.

The selected word appears on the page.

## Formatting text

If you want to format all text in a text object, select the text object.

OR

If you want to format specific text in a text object, double-click the text object, and then select the text.

You can format text using the buttons in the toolbar or the options in the Properties tab or the Format menu.

#### NOTE

If the Properties tab isn't visible, press **Properties** , and then press **Text Style**.



## CHAPTER 4

### Creating basic objects

The following table presents the formatting changes that you can make using the above tools:

Change	Toolbar	Properties tab	Format menu
<b>Character, paragraph or object level</b>			
Change the font face	✓	✓	
Change the font size	✓	✓	
<b>TIP</b> To select a font size that doesn't appear in the drop-down list (including font sizes with decimal values such as 20.5), type the font size in the <i>Font Size</i> box on the toolbar.			
Change the color	✓	✓	
Bold, italicize or underline text	✓	✓	✓
Strike out text	✓ <sup>1</sup>	✓	✓
Superscript or subscript text	✓ <sup>2</sup>	✓	✓
<b>Paragraph or object level</b>			
Change justification (left, right or center)	✓	✓	✓
Change indentation	✓ <sup>3</sup>	✓	✓
Create a bulleted or numbered list	✓ <sup>4</sup>	✓	✓
Insert a drop cap		✓	✓
<b>TIP</b> To insert a drop cap at the beginning of a paragraph, press <b>Drop Cap</b>  in the <i>Properties</i> tab under <i>Text Style</i> . OR Select <b>Format &gt; Paragraph &gt; Drop Cap</b> .			

<sup>1</sup>Under *More Text Options* 



<sup>2</sup>Under *More Text Options* 

<sup>3</sup>Under *More Text Options* 

<sup>4</sup>Under *More Text Options* 

## CHAPTER 4

### Creating basic objects

Change	Toolbar	Properties tab	Format menu
Change line spacing		✓	✓
 <b>TIP</b> To add spacing between paragraphs, select the <b>Add space after paragraphs</b> check box in the Properties tab or select <b>Format &gt; Paragraph &gt; Line Spacing &gt; Add space after paragraphs</b> .			
Change language direction (left-to-right or right-to-left)			✓
 <b>NOTE</b> Select <b>Format &gt; Paragraph &gt; Direction &gt; Left to Right</b> for languages that read left to right (for example, English and French). OR Select <b>Format &gt; Paragraph &gt; Direction &gt; Right to Left</b> for languages that read right to left (for example, Arabic and Hebrew).			
<b>Object level</b>			
Change text direction (horizontal or vertical)	✓ <sup>5</sup>	✓	✓
Change transparency	✓	✓	

## Resizing text objects

When you resize a text object following the procedure in *Resizing objects* on page 61, the text in the object changes size.

If you want to resize the text object without changing the size of the text in the object, complete the following procedure.

### To resize a text object

1. Double-click the text object.
2. Press one of the two white circles on either side of text object, and then drag the circle to increase or reduce the text object's size.

---

<sup>5</sup>Under *More Text Options* 

## Inserting mathematical symbols



You can insert a variety of mathematical and scientific symbols into a page.



### NOTE

The mathematical symbols are characters only. They don't perform mathematical operations.

#### To insert a mathematical symbol



1. Type text on a page.
2. Press **More Text Options**  and then select **Insert Symbol** .  
The *Characters* dialog box appears.
3. Press a category.  
A list of symbols appears.
4. Press the symbol you want to add to the text.
5. Press **Insert**.  
The symbol appears in the text object.

## Checking the spelling of text objects

As you type text, SMART Notebook software checks the spelling. If you spell a word incorrectly, SMART Notebook software underlines the word red. You can then right-click the word and select the correct spelling from a list of options.

If you prefer, you can disable this feature and check the spelling using the *Spelling Check* dialog box.

#### To disable automatic spell checking

1. Press **Text** .
2. Press **More Text Options** , and then select **Check Spelling** .

#### To manually check spelling of a text object

1. Select the text object.
2. Press the object's menu arrow, and then select **Check Spelling**.

If SMART Notebook software finds a misspelled word, the *Spelling Check* dialog box appears. This dialog box displays the misspelled word and suggests alternatives.

## CHAPTER 4

### Creating basic objects

3. For each misspelled word, do one of the following:
  - To keep the word's current spelling for this instance, press **Ignore Once**.
  - To keep the word's current spelling for all instances in the file, press **Ignore All**.
  - To keep the word's current spelling for all instances in the file and add the spelling to the dictionary, press **Add to Dictionary**.
  - To change the word's spelling for this instance, select the correct word in the *Suggestions* list, and then press **Change**.
  - To change the word's spelling for all instances in the file, select the correct word in the *Suggestions* list, and then press **Change All**.



#### NOTE

If you pressed a button by mistake, press **Undo** to undo the resulting change.

After you complete this step for each misspelled word, a dialog box appears asking whether you want to check the spelling in the rest of the file.

4. Press **Yes** to check the remainder of the file.

OR

Press **No** to close the *Spelling Check* dialog box without checking the rest of the file.

## Cutting and pasting text

You can cut, copy and paste text objects like any other objects (see *Cutting, copying and pasting objects* on page 59). You can also cut and paste text in a text object.

### To cut and paste text to another location on the same page

1. Double-click the text object.
2. Select the text you want to cut.
3. Drag the selected text to another location on the same page.

### To cut and paste text to another page

1. If the Page Sorter tab isn't visible, press **Page Sorter** .
2. Double-click the text object.
3. Select the text you want to copy.
4. Drag the selected text to the other page's icon in the Page Sorter tab.

## Creating tables

You can create tables in SMART Notebook software or paste them from other programs. After you create a table, you can insert objects into the table's cells.

If you want to customize a table, you can select a table, column, row, cell or selection of cells, and then do any of the following:

- Move the table
- Change line type, fill and text properties
- Resize the table, a column or a row
- Insert or remove columns, rows or cells
- Split or merge cells
- Delete the table

## Creating tables

### To insert a table using the Table button

1. Press **Table** .

A grid appears.

2. Move the pointer over the grid to select the number of columns and rows that you want in the table.



#### NOTE

The cells of the grid correspond to the cells of your table.



#### TIP

The grid displays eight rows and eight columns by default. You can add rows by moving the pointer past the bottom row. Similarly, you can add columns by moving the pointer past the right row.

If you're using a mouse, click and hold the mouse button while moving the pointer.

3. Press the screen or click your mouse.

The table appears on the page.

**To insert a table using the Insert Table dialog box**

1. Select **Insert > Table**.

The *Insert Table* dialog box appears.

2. Type the number of rows and columns in the boxes.
3. Optionally, select **Make cells square** to make the table cells square.
4. Optionally, select **Remember dimensions for new tables** to use the current table dimensions for all future tables that you create in SMART Notebook software.
5. Press **OK**.

The table appears on the page.

**To draw a table**

1. Press **Pens** .

The Pens tool buttons appear.

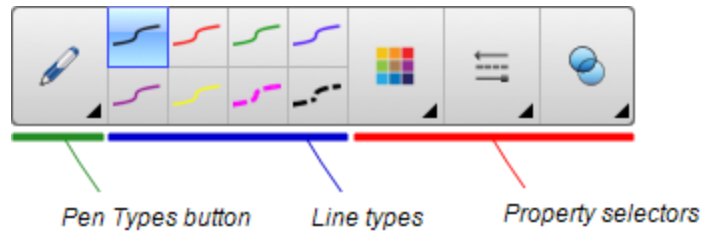

2. Press **Pen Types**, and then select **Pen** or **Calligraphic Pen**.
3. Select a line type.
4. Draw a table on the screen.



**TIP**

Make the lines of the table as straight as possible and connect the corners.

5. Press **Select** .
6. Select your drawing.
7. Press the menu arrow, and then select **Recognize Table**.

If SMART Notebook software recognizes your drawing as a table, it removes your drawing and adds a table to the page.

## Pasting tables from other programs

You can cut or copy a table from Word or PowerPoint®, and then paste it into a .notebook file. The table's formatting and layout can vary when the table appears in the .notebook file.

If you want to cut or copy more than one table, you must cut or copy each table individually.

### NOTE

You can also cut or copy a table from a .notebook file, and then paste it into Word or PowerPoint. However, the table's formatting and layout can vary when the table appears in Word or PowerPoint.

If you're pasting a table into PowerPoint which has cells that contain non-text objects, the non-text objects appear outside of the table in PowerPoint.

## Adding objects to tables

After you insert a table on a page, you can insert objects into the table's cells.

### NOTE

You can add only one object to each cell. If you want to add multiple objects to a cell, do one of the following:

- Group the objects before adding them to the table (see *Grouping objects* on page 65).
- Select all of the objects at once, and then add them to the table as described in the following procedure. SMART Notebook software automatically groups the objects in the table cell.

### To add an object to a table

1. Select the object.
2. Drag the object to the table cell.

### NOTE

You're unable to move an object if it's locked in place (see *Locking objects* on page 96).

The object appears in the table cell.

### NOTE

If you add a text object to a table, the cell resizes to fit to the text object. If you add other object types to the table, the object resizes to fit the cell.

## CHAPTER 4

### Creating basic objects

#### To remove an object from a table

1. Select the object.
2. Drag the object out of the table.

### Selecting tables, columns, rows or cells

You can select a table, column, row, cell or selection of cells. After you select a table or part of a table, you can do the following:

- Move the table
- Change the table's or cells' properties
- Resize the table, columns or rows
- Add or remove columns, rows or cells
- Split or merge cells
- Delete the table

#### To select a table

1. Press **Select** .
2. Press outside, but near to, a corner of the table, and then drag to the opposite corner.



#### NOTE

Don't start dragging from inside the table. If you do, you select a table cell instead of the table.

#### To select a column

1. Press **Select** .
2. Press inside the column's top cell, and then drag to the bottom cell.

#### To select a row

1. Press **Select** .
2. Press inside the row's leftmost cell, and then drag to the rightmost cell.

#### To select a cell

1. Press **Select** .
2. Press inside the cell.



### To select multiple cells

1. Press **Select** .
2. Press inside the top and leftmost cell, and then drag to the bottom and rightmost cell.



#### NOTE

If you select multiple cells and drag them to a different position on the page, you create a new table consisting of the selected cells and their contents.

## Moving tables

After you create a table, you can move it on the page.

### To move a table

Select the table, and then drag it to a different position on the page.

OR

Select all of the table's cells, and then drag the cells to a different position on the page.

## Changing a table's properties

You can use the Properties tab to change the table's properties, including its transparency, cell color and line color.



### To change a table's fill

1. Select a table, column, row, cell or selection of cells.
2. Press the table's, column's, row's or cell's menu arrow, and then select **Properties**.
3. Press **Fill Effects**.

## CHAPTER 4

### Creating basic objects

#### 4. Select a fill style:

Fill style	Procedure
None (transparent)	Select <b>No fill</b> .
Solid color	<ol style="list-style-type: none"><li>Select <b>Solid fill</b>.</li><li>Do one of the following:<ul style="list-style-type: none"><li>Select one of the 40 colors in the palette.</li><li>Press <b>More</b>, and then select a color in the dialog box.</li><li>Press the eyedropper , and then select a color on the screen.</li></ul></li></ol>
Gradient of two colors	<ol style="list-style-type: none"><li>Select <b>Gradient fill</b>.</li><li>For each color, do one of the following:<ul style="list-style-type: none"><li>Select one of the 40 colors in the palette.</li><li>Press <b>More</b>, and then select a color in the dialog box.</li><li>Press the eyedropper , and then select a color on the screen.</li></ul></li><li>Select an option in the <i>Style</i> drop-down list.</li></ol>
Pattern	<ol style="list-style-type: none"><li>Select <b>Pattern fill</b>.</li><li>Select a pattern.</li></ol>
Picture	<ol style="list-style-type: none"><li>Select <b>Image fill</b>.</li><li>Press <b>Browse</b>.</li><li>Browse to and select the picture you want to use as a background, and then press <b>Open</b>.</li></ol> <div data-bbox="722 1266 1461 1476" style="background-color: #f0f0f0; padding: 10px;"><p> <b>NOTE</b></p><p>If you insert a large picture, a dialog box may appear and prompt you to either reduce the picture's file size or retain the picture's file size. For more information, see <i>Setting image optimization preferences</i> on page 145.</p></div> <ol style="list-style-type: none"><li>Select <b>Keep image size</b> to keep the picture's size, regardless of whether the picture is larger or smaller than the object. OR Select <b>Scale image to fit</b> to resize the picture to fit the object.</li></ol>

#### 5. Optionally, drag the **Object transparency** slider to the right to make the table transparent.

### To change a table's line style

1. Select a table.



#### NOTE

You can only change the line style of an entire table, not individual cells, columns or rows.

2. Press the table's, column's, row's or cell's menu arrow, and then select **Properties**.
3. Press **Line Style**.
4. Change the table's line style.

### To change a table's text style

1. Select a table, column, row, cell or selection of cells.
2. Press the table's, column's, row's or cell's menu arrow, and then select **Properties**.
3. Press **Text Style**.
4. Change the table's text style (see *Formatting text* on page 34).

## Resizing tables, columns or rows

If you want to customize a table, you can resize the table, a column or a row.

### To resize a table

1. Select the table.
2. Press the table's resize handle (the gray circle), and then drag it to increase or reduce the size of the table.

### To resize a column

1. Press **Select** .
2. Press the vertical border to the right of the column.  
A resize pointer appears.
3. Drag the vertical border to resize the column.

## CHAPTER 4

### Creating basic objects

#### To resize a row

1. Press **Select** .
2. Press the horizontal border below the row.  
A resize pointer appears.
3. Drag the horizontal border to resize the row.

#### To resize all cells in a table

1. Select the table.
2. Press the table's menu arrow, and then select **Adjust size**.
3. Select one of the following options:
  - **Make same height** to make all cells in the table the same height.
  - **Make same width** to make all cells in the table the same width.
  - **Make same size** to make all cells in the table the same height and width.
  - **Make cells square** to make all cells in the table square.

## Adding or removing columns, rows or cells

If you want to customize a table, you can add columns or rows.

#### To add a column

1. Select a column.
2. Press the column's menu arrow, and then select **Insert Column**.  
A new column appears to the right of the current column.

#### To remove a column

1. Select the column.
2. Press the column's menu arrow, and then select **Delete Column**.

#### To add a row

1. Select a row.
2. Press the row's menu arrow, and then select **Insert Row**.  
A new row appears below the current row.

## CHAPTER 4

### Creating basic objects

#### To remove a row

1. Select the row.
2. Press the row's menu arrow, and then select **Delete Row**.

#### To remove a cell

1. Select the cell.
2. Press the cell's menu arrow, and then select **Delete Cells**.



#### NOTE

- Removing a cell deletes the contents of the cell.
- You're unable to remove a cell if it provides the only connection between two halves of a table.

## Splitting or merging table cells

You can add tables to your page and insert objects into the table's cells. If you want to customize a table, you can split or merge cells.

#### To split a cell

1. Select the cell.
2. Press the cell's menu arrow, and then select **Split**.
3. Select an option to split the cell into multiple rows and/or columns.



#### NOTE

If you split a cell that contains content, the content appears in the upper-left cell after the split.

#### To merge cells

1. Select the cells.
2. Press the cells' menu arrow, and then select **Merge Cells**.



#### NOTE

If you merge cells that contain content, the merged cell contains the contents of the top-left cell. If the top-left cell is empty, the merged cell contains the contents of the next available non-empty cell, moving from left to right, top to bottom.

## Deleting tables and the contents of tables

You can delete the contents of a table or the table itself.



### NOTE

You can delete all objects on a page, including tables, by clearing the page (see *Clearing pages* on page 132).

#### ■ To delete the contents of a table

1. Select the cells containing the content you want to delete.
2. Press **Delete** .

#### ■ To delete a table

1. Select the table.
2. Press the table's menu arrow, and then select **Delete**.

# Chapter 5

## Working with objects

Selecting objects .....	50
Changing objects' properties .....	52
Changing the fill .....	52
Filling digital ink drawings .....	54
Changing other properties .....	55
Saving tool settings .....	55
Positioning objects .....	55
Moving objects .....	56
Moving objects to another page .....	57
Aligning objects .....	57
Rearranging stacked objects .....	59
Cutting, copying and pasting objects .....	59
Cloning objects .....	60
Resizing objects .....	61
Using the resize handle .....	61
Using the scale gesture .....	62
Rotating objects .....	63
Using the rotation handle .....	63
Using the rotate gesture .....	64
Flipping objects .....	65
Grouping objects .....	65
Grouping objects manually .....	65
Using the menu .....	65
Using the shake gesture .....	66
Grouping objects automatically .....	66
Deleting objects .....	67

---

After creating an object, you can select it and work with it as described in this chapter.



### NOTE

The tasks described in this chapter are for all objects, not just basic objects.

## Selecting objects

Before you can work with an object, you must select it. You can select an individual object, multiple objects or all objects on a page. When you select an object, a selection rectangle appears around it.

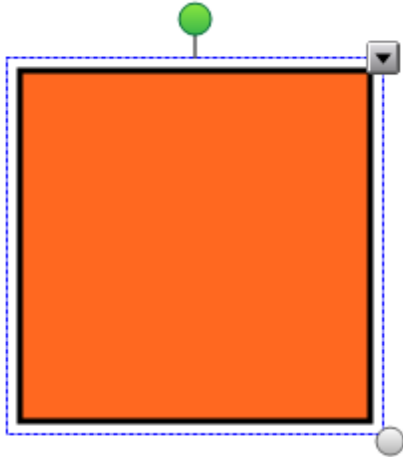

The gray circle in the object's lower-right corner is a resize handle (see *Resizing objects* on page 61).

The green circle above the object is a rotation handle (see *Rotating objects* on page 63).

The downward arrow in the object's upper-right corner is a menu arrow. Press the menu arrow to display a menu of commands.

### NOTE

Pressing an object's menu arrow gives you access to the same menu as Control-clicking the object.

### To select an object

1. Press **Select** .
2. Press the object you want to select.

A selection rectangle appears around the object.

### NOTE

If you press an object and a lock symbol appears instead of the menu arrow, the object is locked. Depending on the type of lock, you might have to unlock the object before you can manipulate it (see *Locking objects* on page 96).



**To select multiple objects**

1. Press **Select** .
2. Press the interactive screen and drag until a rectangle surrounds the objects you want to select.

OR

Hold down the COMMAND (⌘) key, and then press the objects you want to select.

A selection rectangle appears around the selected objects.



**NOTE**

If you draw a rectangle around multiple objects and some of the objects are locked (see *Locking objects* on page 96), you select only the unlocked objects.

**To select all objects on a page**

Select **Edit > Select All**.

A selection rectangle appears around all objects on the page.



**NOTE**

If some of the objects are locked (see *Locking objects* on page 96), you select only the unlocked objects.

**To select all locked objects on the page**

Select **Edit > Select All Locked Notes**.

A selection rectangle appears around all locked objects on the page.

## Changing objects' properties

You can change an object's properties. The properties you can change depend on the object you select. You can also select several objects and change their properties at the same time.



### Changing the fill

You can change an object's fill by selecting the object and then setting the fill in the Properties tab or by clicking **Fill** , setting the fill, and then selecting the object.

#### To change an object's fill by first selecting the object

1. Select the object.
2. If the Properties tab isn't visible, press **Properties** .
3. Press **Fill Effects**.

## 4. Select a fill style:

Fill style	Procedure
None (transparent)	Select <b>No fill</b> .
Solid color	<ol style="list-style-type: none"> <li>Select <b>Solid fill</b>.</li> <li>Do one of the following: <ul style="list-style-type: none"> <li>Select one of the 40 colors in the palette.</li> <li>Press <b>More</b>, and then select a color in the dialog box.</li> <li>Press the eyedropper , and then select a color on the screen.</li> </ul> </li> </ol>
Gradient of two colors	<ol style="list-style-type: none"> <li>Select <b>Gradient fill</b>.</li> <li>For each color, do one of the following: <ul style="list-style-type: none"> <li>Select one of the 40 colors in the palette.</li> <li>Press <b>More</b>, and then select a color in the dialog box.</li> <li>Press the eyedropper , and then select a color on the screen.</li> </ul> </li> <li>Select an option in the <i>Style</i> drop-down list.</li> </ol>
Pattern	<ol style="list-style-type: none"> <li>Select <b>Pattern fill</b>.</li> <li>Select a pattern.</li> </ol>
Picture	<ol style="list-style-type: none"> <li>Select <b>Image fill</b>.</li> <li>Press <b>Browse</b>.</li> <li>Browse to and select the picture you want to use as a background, and then press <b>Open</b>.</li> </ol> <div data-bbox="722 1260 1461 1480" style="background-color: #f0f0f0; padding: 5px; margin: 5px 0;"> <p> <b>NOTE</b></p> <p>If you insert a large picture, a dialog box may appear and prompt you to either reduce the picture's file size or retain the picture's file size. For more information, see <i>Setting image optimization preferences</i> on page 145.</p> </div> <ol style="list-style-type: none"> <li>Select <b>Keep image size</b> to keep the picture's size, regardless of whether the picture is larger or smaller than the object. OR Select <b>Scale image to fit</b> to resize the picture to fit the object.</li> </ol>

5. Optionally, drag the **Object transparency** slider to the right to make the object transparent. **TIP**

You can also change an object's properties using the property selectors on the toolbar.

**To change an object's fill by first pressing the Fill button**

1. Press **Fill** , and then select a color.
2. Select the object.
3. Repeat step 2 for each object you want to apply the fill to.

**Filling digital ink drawings**

In addition to filling shapes, regular polygons and irregular polygons, you can fill areas enclosed by digital ink using the *Fill* button.

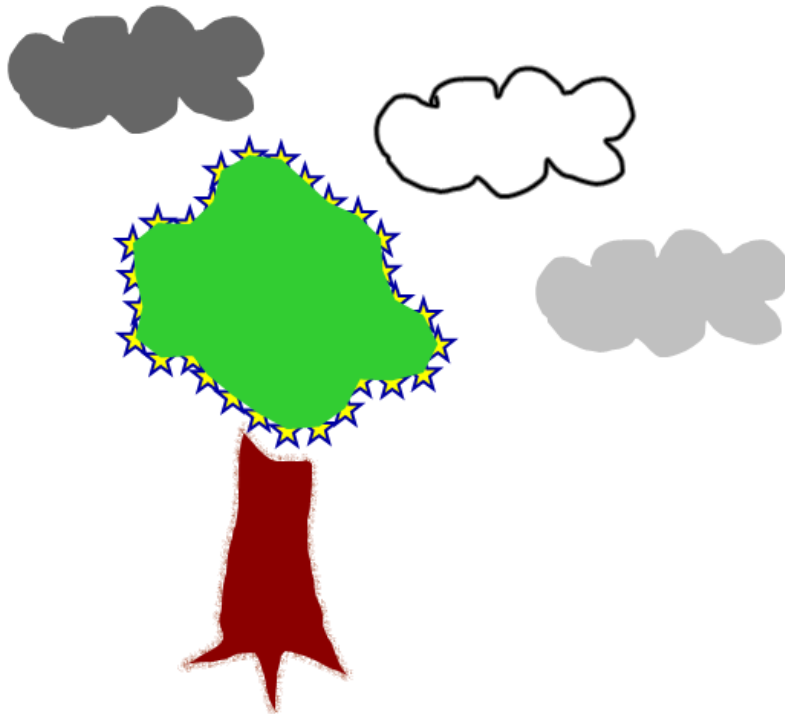

 **NOTES**

- To fill an area, you must enclose it with a single digital ink path.
- You're unable to fill an enclosed area if that area is part of a group (see *Grouping objects* on page 65).
- When you fill an enclosed area, the fill becomes a separate object, which you can move away from the original enclosed area. You can fill the enclosed area and move the resulting fill object multiple times.

## Changing other properties

In addition to fill, you can change objects' line style and text style.

### To change an object's line style

1. Select the object.
2. If the Properties tab isn't visible, press **Properties** .
3. Press **Line Style**.
4. Change the object's line style.

### To change an object's text style

1. Select the object.
2. If the Properties tab isn't visible, press **Properties** .
3. Press **Text Style**.
4. Change the object's text style (see *Formatting text* on page 34).

## Saving tool settings

When you select a tool in the toolbar, you can change its default settings using the Properties tab and then save your changes by clicking **Save Tool Properties**.

When you save your changes to a tool's default settings, the tool's button displays those changes:



To restore the default settings, see *Customizing the toolbar* on page 141.

## Positioning objects

You can change the position of an object by moving it to another area of the existing page or to another page. You can also align objects and change the order of stacked objects.

## Moving objects

You can move objects to another position on the page. You can also flick objects.



### NOTE

You're unable to move an object if it's locked in place (see *Locking objects* on page 96).



### TIP

You can manipulate multiple objects by selecting them, and then creating a group (see *Grouping objects* on page 65).

### To move an object or objects

1. Select the object or objects.
2. Drag the object or objects to a new position on the page.



### TIP

You can move an object in small increments by pressing the arrow keys on your keyboard.

### To move an Adobe® Flash® Player compatible file

1. Press the colored bar at the top of the Adobe Flash Player compatible file.
2. Drag the file to its new position.

### To flick an object

1. Select the object.
2. Quickly flick your finger in any direction.

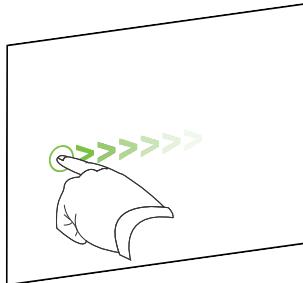

### Moving objects to another page

You can move objects to another page in a file.

#### To move an object or objects to another page

1. If the Page Sorter isn't visible, press **Page Sorter** .
2. If you don't see the page that you want to move the object to, scroll in the Page Sorter until you see the page's thumbnail.
3. Select the object or objects you want to move.
4. Drag the object or objects into the Page Sorter above the thumbnail of the page you want to move the objects to.

#### To move an Adobe Flash Player compatible file to another page

1. If the Page Sorter isn't visible, press **Page Sorter** .
2. If you don't see the page that you want to move the object to, scroll in the Page Sorter until you see the page's thumbnail.
3. Press the colored bar at the top of the Adobe Flash Player compatible file.
4. Drag the file into the Page Sorter above the thumbnail of the page you want to move the object to.

### Aligning objects

You can use the Alignment Tools add-on to align and distribute objects on a page. You can align selected objects on the bottom, left, right, top, vertically or horizontally. You can also align stacked objects vertically or horizontally.

If you want, you can display guidelines on a page to assist you in manually aligning objects with other objects, as well as the page's vertical and horizontal centers. You can also set objects to align automatically with these guidelines when you move the objects on a page (see page 56).









#### To align objects on a page

1. Select the objects you want to align (see *Selecting objects* on page 50).
2. Press **Add-ons**  on the toolbar to display the Alignment Tools buttons.

## CHAPTER 5

### Working with objects

3. Press an alignment button:

Button	Name	Select this button to:
	Align bottom	Align selected objects along their bottom edge.
	Align left	Align selected objects along their left edge.
	Align middle X	Align selected objects vertically through the middle of the objects.
	Align middle Y	Align selected objects horizontally through the middle of the objects.
	Align right	Align selected objects along their right edge.
	Align top	Align selected objects along their top edge.
	Stack horizontally	Align selected stacked objects horizontally.
	Stack vertically	Align selected stacked objects vertically.

### To display guidelines

1. Select **View > Alignment**.

A dialog box appears.

2. Select check boxes to specify which guidelines you want to display:

Check box	Select this check box to:
<b>Show guides for active objects</b>	Display a guideline when you move an object into alignment with another object.
<b>Show vertical page center guide</b>	Display a guideline when you move an object into alignment with the page's vertical center.
<b>Show horizontal page center guide</b>	Display a guideline when you move an object into alignment with the page's horizontal center.
<b>Snap objects to guides</b>	Automatically align objects to guidelines when you move the objects on a page.

3. If you want to change the color of the guidelines, press the colored bar to the left of *Guide color*, and then select a color.
4. Press **OK**.



## Rearranging stacked objects

If objects overlap on a page, you can rearrange the order of the stack (that is, you can control which objects appear in front of others).



### NOTE

You're unable to move an object in the stack if it's locked in place (see *Locking objects* on page 96).

#### To move an object to the front of the stack

1. Select the object.
2. Press the object's menu arrow, and then select **Order > Bring to Front**.

#### To move an object to the back of the stack

1. Select the object.
2. Press the object's menu arrow, and then select **Order > Send to Back**.

#### To move an object one place forward in the stack

1. Select the object.
2. Press the object's menu arrow, and then select **Order > Bring Forward**.

#### To move an object one place backward in the stack

1. Select the object.
2. Select the object's menu arrow, and then select **Order > Send Backward**.

## Cutting, copying and pasting objects

You can cut, copy and paste objects—including text, pictures, straight lines, arcs and shapes—in a .notebook file.



### TIPS

- You can paste text from other programs into SMART Notebook software and cut text from SMART Notebook software and paste it into other programs (see *Cutting, copying and pasting content from other programs* on page 77 and *Cutting and pasting text* on page 38).
- You can create an exact copy of an object by cloning it (see *Cloning objects* on the next page).

### To cut and paste an object

1. Select the object.
2. Press the object's menu arrow, and then select **Cut**.

#### TIP

Alternatively, you can press **Cut**  if you added this button to the toolbar (see *Customizing the toolbar* on page 141).

3. If you want to paste the object onto a different page, display that page.
4. Press **Paste** .

### To copy and paste an object

1. Select the object.
2. Press the object's menu arrow, and then select **Copy**.

#### TIP

Alternatively, you can press **Copy**  if you added this button to the toolbar (see *Customizing the toolbar* on page 141).

3. If you want to paste the item onto a different page, display that page.
4. Press **Paste** .

## Cloning objects

You can create a duplicate of an object by using the Clone command, or you can create multiple copies of an object using the Infinite Cloner command.

#### NOTE

You can also copy and paste objects, including text, images, straight lines, arcs and shapes (see *Cutting, copying and pasting objects* on the previous page).

### To clone an object

1. Select the object.
2. Press the object's menu arrow, and then select **Clone**.

A duplicate object appears on the page.

### To clone an object using the Infinite Cloner

1. Select the object.
2. Press the object's menu arrow, and then select **Infinite Cloner**.
3. Select the object again.  
An infinity symbol appears instead of the object's menu arrow.
4. Drag the object to another position on the page.
5. Repeat step 4 as many times as you want.
6. When you finish cloning the object, select the original object.
7. Press the infinity symbol, and then clear the selection of **Infinite Cloner**.

## Resizing objects

You can resize objects on a page by using the resize handle or the scale gesture (if your interactive product supports multitouch gestures).



### NOTE

You're unable to resize an object if it's locked in place (see *Locking objects* on page 96).

## Using the resize handle

### To resize an object

1. Select the object.
2. Press the object's resize handle (the gray circle), and then drag it to increase or reduce the object's size.

### To resize multiple objects

1. Group the objects (see *Grouping objects* on page 65), and then select the group.  
A selection rectangle appears around the group.
2. Press the resize handle in the lower-right corner of the selection rectangle.
3. Drag the resize handle to increase or reduce the size of the objects.

## Using the scale gesture

### **To resize an object from its center**

1. Select the object.
2. Using one finger on each hand, press the screen at opposite ends of the object.
3. Drag your fingers in opposite directions to increase the object's size.

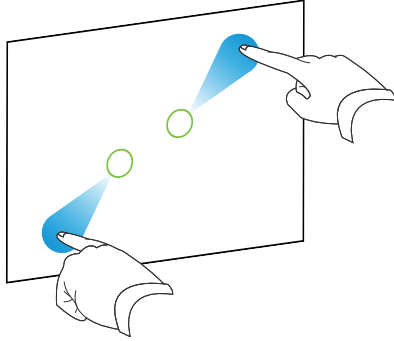

OR

Drag your fingers toward each other to decrease the object's size.

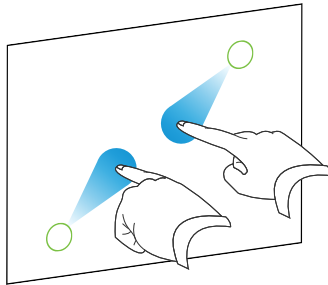

### **To resize an object from its corner or side**

1. Select the object.
2. Using one finger on each hand, press the screen at the corner or side you want to resize the object from.
3. Drag your fingers in opposite directions to increase the object's size.

OR

Drag your fingers toward each other to decrease the object's size.

### To resize multiple objects

1. Select the objects.
2. Using one finger on each hand, press the screen at opposite ends of one of the objects.
3. Drag your fingers in opposite directions to increase the objects' size.

OR

Drag your fingers toward each other to decrease the objects' size.



#### NOTE

The objects resize from their centers regardless of where you press the screen.

## Rotating objects

You can rotate objects on a page by using the rotation handle or the rotate gesture (if your interactive product supports multitouch gestures).



#### NOTES

- You're unable to rotate an object if it's locked in place (see *Locking objects* on page 96).
- You're unable to rotate tables.

## Using the rotation handle

### To rotate an object

1. Select the object.
2. Press the object's rotation handle (the green circle), and then drag it in the direction you want to rotate the object.

### To rotate multiple objects

1. Select the objects.

A selection rectangle appears around each object.

2. Press the rotation handle (the green circle) on any one of the selected objects, and then drag it in the direction you want to rotate the object. When you rotate one object, all other selected objects rotate automatically.

## Using the rotate gesture

### To rotate an object around its center

1. Select the object.
2. Using one finger on each hand, press the screen at opposite ends of the object.
3. Move your fingers in a circle around the center of the object to rotate it.

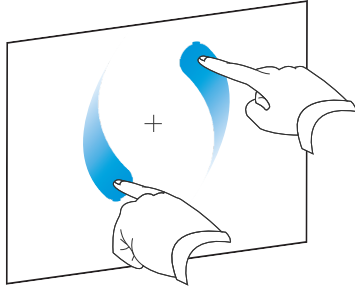

### To rotate an object around a corner

1. Select the object.
2. Using one finger on each hand, press the screen in the corner you want to rotate the object around.
3. Move your fingers in a circle around the corner to rotate the object.

### To rotate multiple objects

1. Select the objects.
2. Using one finger on each hand, press the screen at opposite ends of one of the objects.
3. Move your fingers in a circle.



#### NOTE

The objects rotate around their centers regardless of where you press the screen.

## Flipping objects

You can flip an object on a page.



### NOTE

You're unable to flip an object if it's locked in place (see *Locking objects* on page 96).

#### ■ To flip an object

1. Select the object.
2. Press the object's menu arrow, and then select **Flip > Up/Down** or **Flip > Left/Right**.

#### ■ To flip multiple objects

1. Select the objects.
2. Press the menu arrow on any one of the selected objects, and then select **Flip > Up/Down** or **Flip > Left/Right**.

## Grouping objects

You can create a group of objects, which lets you interact with all grouped items at the same time. After you create a group, you can select, move, rotate or resize the group as if it were an individual object. However, if you want to interact with an individual object in a group, you must ungroup the objects first.

### Grouping objects manually

You can group and ungroup objects manually using the menu or the shake gesture.

#### Using the menu

#### ■ To group objects

1. Select the objects.
2. Press the menu arrow of any one of the selected objects, and then select **Group > Group**.

#### ■ To ungroup objects

1. Select the group.
2. Press the group's menu arrow, and then select **Group > Ungroup**.

## Using the shake gesture

### NOTES

- You're unable to use the shake gesture with a mouse.
- The shake gesture works only when you initially contact your interactive product's surface.

### To group objects

Quickly shake your finger over the objects three times.

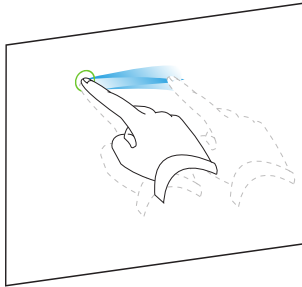

### To ungroup objects

Quickly shake your finger over the group three times.

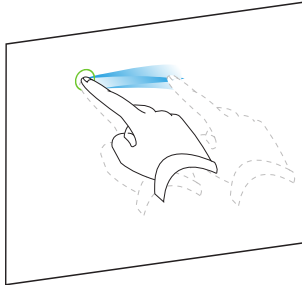

## Grouping objects automatically

If you write or draw multiple lines, SMART Notebook software automatically combines the lines into a single object. For example, if you write the letters of a word, SMART Notebook software combines the individual letters, enabling you to interact with the whole word. If you want to write words on the same line but don't want them combined, leave a large gap between them, use different pens, or briefly put the pen in the pen tray before writing another word (interactive whiteboards only).

If SMART Notebook software combined lines that you want to manipulate individually, ungroup the lines as described above.



## Deleting objects

Although you can erase digital ink (see *Erasing digital ink* on page 28), you're unable to erase some types of objects, including text, shapes, straight lines, arcs and pictures. To remove these types of objects from a page, you must delete them.



### NOTE

You're unable to delete an object if it's locked in place (see *Locking objects* on page 96). To delete a locked object from a page, you must unlock it.

### ■ To delete an object

1. Select the object.
2. Press the object's menu arrow, and then select **Delete**.



## Chapter 6

# Inserting, organizing and sharing content

Inserting content from the Gallery .....	70
Inserting content from the SMART Exchange website .....	72
Inserting content from other sources .....	72
Inserting pictures .....	73
Inserting pictures from files .....	73
Inserting pictures from a SMART Document Camera .....	73
Working with pictures .....	73
Creating transparent areas in a picture .....	74
Inserting multimedia files .....	74
Inserting Adobe Flash Player compatible files .....	74
Inserting Adobe Flash Player compatible video files .....	76
Inserting sound files .....	76
Working with multimedia files .....	76
Installing encoders for additional formats .....	77
Inserting content from other programs .....	77
Cutting, copying and pasting content from other programs .....	77
Importing files from other interactive whiteboard programs .....	78
Inserting Internet browsers .....	78
Inserting an Internet browser .....	79
Configuring proxy servers .....	79
Attaching files and web pages .....	80
Organizing and sharing content using the Gallery .....	81
Adding content to the Gallery .....	82
Organizing content in the Gallery .....	83
Sharing content with other teachers .....	84
Connecting to Team Content categories .....	85
Sharing content using the SMART Exchange website .....	86

---

You can insert pictures, multimedia files and other content into your .notebook files from a variety of sources. These sources include the Gallery, the SMART Exchange™ website and the Internet.

## CHAPTER 6

Inserting, organizing and sharing content

After inserting your content, you can organize it using the Gallery and share it with other teachers using the Gallery or the SMART Exchange website.

# Inserting content from the Gallery

The Gallery is a tab in the SMART Notebook software user interface where you can browse or search for content and then add that content to your .notebook files.

The Gallery contains Lesson Activity Examples, which includes Activity Builder examples (see *Creating a matching lesson activity* on page 102), interactive techniques and 3D models to aid you in creating lesson activities.

When your system administrator installs SMART Notebook software, he or she can install the following additional items:

- Gallery Essentials is a collection of thousands of pictures, multimedia objects and more, organized into subject-specific categories.
- Lesson Activity Toolkit is a collection of customizable tools and templates that you can use to create professional-looking and interactive lessons. The toolkit helps you create engaging content like word games, quizzes and sorting activities. It also offers Adobe Flash Player compatible files like hide-and-reveal and drag-and-drop.

The Gallery is divided into two sections. The top section of the Gallery is the category list. When you select a category or subcategory in the list, its contents appear in the bottom section of the Gallery.

### TIP

You can change the size of the category list and content list by pressing the boundary between them, and then dragging it up or down.

You can browse the category list to view the contents of each category. Thumbnails in the categories provide preview images of the content.

- In *Pictures*, pictures appear as thumbnails.
- In *Interactive and Multimedia*, video objects appear as a single frame from the videos, sound objects appear with a speaker icon in the lower-left corner, and Adobe Flash Player compatible files appear as an Adobe Flash icon or thumbnail of the content with a small Adobe Flash icon in the upper-left corner.
- In *3D Objects*, 3D models appear as thumbnails.

## CHAPTER 6

Inserting, organizing and sharing content

- In *Notebook Files and Pages*, files appear as binders and pages appear with a folded upper-right corner.
- In *Backgrounds and Themes*, backgrounds appear as pages with a folded lower-right corner and themes appear as thumbnails.

You can search for a Gallery item using the keyword search.

After browsing or searching for a Gallery item, you can add it to your .notebook file.

### To browse the Gallery

1. If the Gallery isn't visible, press **Gallery** .
2. Press a category's disclosure triangle to view its subcategories.





#### NOTE

You can close a category by pressing the category's disclosure triangle a second time.

3. Select a category or subcategory to display its contents.

### To search the Gallery

1. If the Gallery isn't visible, press **Gallery** .
  2. Type a keyword into the *Type search terms here* box, and then press **Search** .
- The Gallery displays all content containing the keyword.

### To add a Gallery item to your .notebook file

1. If the Gallery isn't visible, press **Gallery** .
2. Browse or search for the Gallery item you want to add.
3. Double-click the Gallery item's thumbnail.
  - If you add a picture, Adobe Flash Player compatible file, video file or sound file, it appears on the current page.
  - If you add a background, it replaces the page's existing background (see *Applying page backgrounds and themes* on page 98).
  - If you add a page from a .notebook file, SMART Notebook software inserts it before the current page.
  - If you add a .notebook file, SMART Notebook software inserts the file's pages before the current page.

## Inserting content from the SMART Exchange website

The SMART Exchange website ([exchange.smarttech.com](http://exchange.smarttech.com)) includes thousands of lesson plans, question sets, widgets and other content that you can download and then open in SMART Notebook software.



### NOTE

You can also share your lesson plans with other teachers through the SMART Exchange website. For more information, see *Sharing content using the SMART Exchange website* on page 86.

### To insert content from the SMART Exchange website

1. Press **SMART Exchange** .

The SMART Exchange website opens in your web browser.

2. If you're new to the SMART Exchange website, press **Join for free**, and then follow the on-screen instructions to create an account.

OR

If you have an account, press **Sign In**, and then follow the on-screen instructions to log on to the SMART Exchange website with your account.

3. Search or browse for content, and then download it to your computer.
4. Import content into the Gallery (see *Sharing content with other teachers* on page 84).

## Inserting content from other sources

If you or other teachers in your school have created content outside of SMART Notebook software, you can include this content in your .notebook files. Specifically, you can do the following:

- Insert pictures, Adobe Flash Player compatible files and video files, and sound files
- Cut or copy, and then paste content from other programs
- Import content from other programs

## CHAPTER 6

Inserting, organizing and sharing content

### Inserting pictures

You can insert pictures into pages from files, a scanner or a SMART Document Camera.



#### NOTE

You can also insert pictures from the Gallery tab. For more information, see *Inserting content from the Gallery* on page 70.

After inserting a picture, you can define a transparent area in it.

#### Inserting pictures from files

You can insert a picture into a page.

SMART Notebook software supports BMP, GIF, JPEG and PNG formats.

#### To insert a picture from a file

1. Select **Insert > Picture**.

The *Open* dialog box appears.

2. Browse to and select the picture you want to insert.
3. Press **Open**.

The picture appears in the upper-left corner of the page.

#### Inserting pictures from a SMART Document Camera

You can insert pictures from a SMART Document Camera into a page.

#### To insert a picture from a SMART Document Camera

1. Select **Insert > Picture from SMART Document Camera**.

The *SMART Document Camera* window appears on the page.

2. Insert a picture following the instructions in the Help.

#### Working with pictures

When you insert a picture in a .notebook file, the picture becomes an object in the file. Therefore, you can move, resize, rotate and make other changes to the picture like any other object.

For information on how to work with objects, including pictures, in .notebook files, see *Working with objects* on page 49.

## CHAPTER 6

Inserting, organizing and sharing content

### Creating transparent areas in a picture

You can create transparent areas in a picture that you insert into a page. This is useful for removing the picture's background. You can make any color in the picture transparent.

#### NOTE

You can reduce the size of a large picture when you insert it in a file (see *Setting image optimization preferences* on page 145). If you later create a transparent area in the picture, the picture is no longer optimized.

### To create a transparent area in a picture

1. Select the picture.
2. Press the picture's menu arrow, and then select **Set Picture Transparency**.

The *Picture Transparency* dialog box appears.

3. Press any areas in the picture that you want to make transparent.

#### NOTE

Pressing an area makes only that area transparent, even if the picture includes that same color in other areas.

4. Press **OK**.

## Inserting multimedia files

You can insert multimedia files, including Adobe Flash Player compatible files, video files and sound files, into pages.

#### NOTE

You can also insert multimedia files from the Gallery tab. For more information, see *Inserting content from the Gallery* on page 70.

### Inserting Adobe Flash Player compatible files

You can insert Adobe Flash Player compatible files into a page.

After you insert an Adobe Flash Player compatible file into a page, or display a page that already contains an Adobe Flash Player compatible file, the file plays immediately. You can control the playback of the file. If the file has buttons, you can press them on your interactive product. If the file doesn't have buttons, you can use the options in the file's menu arrow.





### NOTES

- Adobe Flash Player compatible files on a page must be self-extracting. You're unable to use Adobe Flash Player compatible files that load or rely on other Adobe Flash Player compatible files.
- You're unable to drag an Adobe Flash Player compatible file from an Internet browser into a page.
- To write on top of an Adobe Flash Player compatible file with a handwriting recognition component, start writing outside the file and continue to write over the file. This enables SMART Notebook software to recognize the digital ink as a separate object from the Adobe Flash Player compatible file.

#### To insert an Adobe Flash Player compatible file

1. Select **Insert > Adobe Flash Player Compatible File**.

The *Open* dialog box appears.

2. Browse to and select the Adobe Flash Player compatible file that you want to insert into the page.
3. Press **Open**.

The Adobe Flash Player compatible file appears in the upper-left corner of the page.

#### To control an Adobe Flash Player compatible file

1. Select the Adobe Flash Player compatible file.
2. Control the file by doing any of the following:
  - To play the file, press the file's menu arrow, and then select **Flash > Play**.
  - To play the file from the beginning, press the file's menu arrow, and then select **Flash > Rewind**.
  - To advance the file slightly and pause playback, press the file's menu arrow, and then select **Flash > Step Forward**.
  - To rewind the file slightly and pause playback, press the file's menu arrow, and then select **Flash > Step Back**.
  - To play the file continuously, press the file's menu arrow, and then select **Flash > Loop**.
  - To stop playing the file continuously, press the file's menu arrow, and then clear the selection of **Flash > Loop**.

## CHAPTER 6

Inserting, organizing and sharing content

### Inserting Adobe Flash Player compatible video files

You can insert Adobe Flash Player compatible video files into a page.



#### NOTE

SMART Notebook software supports the Adobe Flash Player compatible video file (FLV) format. If you want SMART Notebook software to support other file types, you can install additional encoders (see *Installing encoders for additional formats* on the next page).

### To insert an Adobe Flash Player compatible video file

1. Select **Insert > Video**.

The *Open* dialog box appears.

2. Browse to and select the Adobe Flash Player compatible video file that you want to insert into the page.
3. Press **Open**.

### Inserting sound files

You can attach a sound file to any object (except Adobe Flash Player compatible objects) in a .notebook file. For more information, see *Adding sounds to objects* on page 94.

### Working with multimedia files

When you insert a multimedia file in a .notebook file, the multimedia file becomes an object in the file. Therefore, you can move, resize, rotate and make other changes to the multimedia file like any other object.

For information on how to work with objects, including multimedia files, in .notebook files, see *Working with objects* on page 49.

## CHAPTER 6

Inserting, organizing and sharing content

### Installing encoders for additional formats

SMART Notebook software supports the FLV and MP3 formats. If you want SMART Notebook software to support other video and audio formats, you can install the following encoder. If you install this encoder, SMART Notebook software automatically detects it and supports its video and audio formats.

Encoder	Video formats	Audio formats	Link
ffmpegX 0.0.9y	<ul style="list-style-type: none"><li>• WAV</li><li>• WMA</li><li>• ASF</li><li>• AVI</li><li>• MOV</li><li>• MP4</li><li>• MPEG and MPG</li><li>• WMV</li></ul>	<ul style="list-style-type: none"><li>• AIF and AIFF</li><li>• WAV</li><li>• WMA</li></ul>	<a href="http://ffmpegx.com/download.html">ffmpegx.com/download.html</a>



#### NOTE

SMART Technologies ULC provides links to these programs as a courtesy, and makes no representations or warranties regarding the programs or any information related thereto. Any questions, complaints or claims regarding the programs must be directed to the appropriate software vendor.

### Inserting content from other programs

If you have content in other programs that you want to use in your .notebook files, you can move this content to SMART Notebook software by doing one of the following:

- Cutting or copying, and then pasting the content
- Importing the content

#### Cutting, copying and pasting content from other programs

You can cut or copy, and then paste content from other programs into SMART Notebook software.

#### To cut content from another program

1. In the other program, select the content you want to cut, and then select **Edit > Cut**.
2. In SMART Notebook software, press **Paste** .

## CHAPTER 6

Inserting, organizing and sharing content

### To copy content from another program

1. In the other program, select the content you want to copy, and then select **Edit > Copy**.
2. In SMART Notebook software, press **Paste** .

### Importing files from other interactive whiteboard programs

You can import content into .notebook files from a variety of sources, including other interactive whiteboard programs.

If the other interactive whiteboard programs support the Interactive Whiteboard Common File Format (CFF), you can export a CFF file from those programs and then import that CFF file into SMART Notebook software.



#### NOTE

You can also export CFF files (see *Exporting files* on page 13).

### To import CFF files

1. Select **File > Import > All Common File Format Files (.IWB)**.  
A dialog box appears.
2. Browse to and select the file you want to import.
3. Press **Open**.  
The file opens.

## Inserting Internet browsers

You can insert an Internet browser into a .notebook page. In the Internet browser, you can browse to and display web pages. You can modify the Internet browser like any other object in SMART Notebook software (see *Working with objects* on page 49).



#### NOTE

When you resize an Internet browser, the Internet browser's content scales automatically so that you always see the entire web page that you are viewing.

## Inserting an Internet browser

### To insert an Internet browser

1. Select **Insert > Internet Browser**.







An Internet browser appears.

2. Double-click the address bar, type the address of the web page you want to browse to, and then press **Go** .

#### TIP

If there's no keyboard connected to your computer, click **SMART Keyboard**  to display an on-screen keyboard.

3. Interact with the website using the buttons in the Internet browser toolbar:

Button	Command	Action
	Back	Display the previous web page.
	Forward	Display the next web page.
	Return to Pinned Page	Open the pinned web page.
	Pin Page	Pin the current web page. When you first open the .notebook file, the pinned web page appears in the Internet browser. You can return to the pinned page at any time by pressing <b>Return to Pinned Page</b>  .
	Reload	Reload the current web page.
	Move Toolbar	Change the position of the Internet browser toolbar.

## Configuring proxy servers

Internet browsers in SMART Notebook software work with any proxy server that adheres to the RFC 2068 HTTP standard. If your system administrator installed SMART Notebook software behind a proxy server, he or she must create access policy rules for inbound and outbound traffic on that proxy server. Your system administrator can further enhance network security by enabling authentication, such as basic or NT LAN Manager (NTLM) authentication.

#### NOTE

Although proxy servers protect internal networks from intruders, they unavoidably introduce network latency.

## Attaching files and web pages

You can attach copies of files, aliases for files and links to web pages using the Attachments tab.



Attaching files or web pages enables you to find and open these items easily while presenting a .notebook file.



### NOTES

- You can also link a file or web page to an object on a page (see *Adding links to objects* on page 92).
- As an alternative to attaching a link to a web page, you can also insert an Internet browser in your .notebook file (see *Inserting Internet browsers* on page 78).

### To attach a copy of a file

1. If the Attachments tab isn't visible, press **Attachments** .
2. Press **Insert File**  at the bottom of the *Attachments* tab  
The *Open* dialog box appears.
3. Browse to and select the file you want to attach.
4. Select **Copy of File**.
5. Press **Open**.



The file's name and size appear in the *Attachments* tab.



### NOTE

When you attach a file, the size of the .notebook file increases. Although SMART Notebook software compresses files to conserve space, SMART Notebook software can compress some file types more than others.

### To attach an alias for a file

1. If the Attachments tab isn't visible, press **Attachments** .
2. Press **Insert File**  at the bottom of the *Attachments* tab.  
The *Open* dialog box appears.
3. Browse to and select the file you want to attach.
4. Select **Alias**.

## CHAPTER 6

Inserting, organizing and sharing content

### 5. Press **Open**.



The file name and *alias* appear in the *Attachments* tab.



#### NOTES

- SMART Notebook software doesn't export aliases. If you want to export file attachments, attach a copy of your file, not an alias for the file.
- Make sure that the file is accessible on the computer you will use during the lesson.

### To attach a link to a web page

1. If the Attachments tab isn't visible, press **Attachments** .
2. Press **Insert Hyperlink**  at the bottom of the *Attachments* tab.  
A dialog box appears.
3. Type the web page's address in the *Hyperlink* box.
4. Type a name for the link in the *Display Name* box.
5. Press **Insert Hyperlink**.

The display name and *URL* appear in the *Attachments* tab.

### To open a file or web page from the Attachments tab

1. If the Attachments tab isn't visible, press **Attachments** .
- The Attachments tab lists all attachments in the open file.
- If an attached item is a copy of a file, the file's size appears in the *Size* column.
  - If an attached item is an alias for a file, *alias* appears in the *Size* column.
  - If an attached item is a link to a web page, *URL* appears in the *Size* column.
2. To open a file, double-click the file name or alias.

OR

To open a web page, double-click the link.

## Organizing and sharing content using the Gallery

The Gallery is a tab in the SMART Notebook software user interface where you can browse or search for content and then add that content to your .notebook files. The Gallery consists of a set of categories, one of which is the My Content category.

## CHAPTER 6

Inserting, organizing and sharing content

If you find you use the same content across multiple .notebook files, you can add this content to the My Content category. You can share content from the My Content category with other teachers in your school by importing or exporting Gallery collection files. You can also connect to a Team Content category containing content that you and other teachers in your school contribute to.

After adding your content to the Gallery, you can insert it into .notebook files as described in *Inserting content from the Gallery* on page 70.

### Adding content to the Gallery

You can add SMART Notebook software objects and pages as well as supported files to the My Content category in the Gallery.

#### To add an object to the Gallery

1. If the Gallery isn't visible, press **Gallery** .
2. Select the object that you want to add to the Gallery.
3. Drag the object from the page to the Gallery's *My Content* category or one of its subcategories.



#### NOTES

- You're unable to drag an object if it's locked in place (see *Locking objects* on page 96).
- If you want to change a Gallery item's name, select the item, press its menu arrow, and then select **Rename**.

#### To add a page to the Gallery

1. Create and modify objects on the page until the page appears exactly as you want it to.
2. Select **File > Export Page as Gallery Item**.  
A dialog box appears.
3. Browse to the folder where you want to save the page.
4. Type a name for the page in the *Save As* box.
5. Press **Save**.
6. If the Gallery isn't visible, press **Gallery** .



## CHAPTER 6

Inserting, organizing and sharing content

7. Select **My Content** (or one of its subcategories) in the Gallery's category list, press its menu arrow, and then select **Add to My Content**.

The *Open* dialog box appears.

8. Browse to and select the item that you saved in step 5.
9. Press **Open**.

### To add a supported file to the Gallery

1. If the Gallery isn't visible, press **Gallery** .
2. Select **My Content** (or one of its subcategories) in the Gallery's category list, press its menu arrow, and then select **Add to My Content**.

The *Open* dialog box appears.

3. Browse to and select the item you want to add to the Gallery.
4. Press **Open**.



#### NOTE

By default, SMART Notebook software names the new Gallery item based on the original file name. If you want to change the item's name, select the Gallery item's thumbnail, press its menu arrow, and then select **Rename**.

## Organizing content in the Gallery

As you add objects, pages and supported files to the My Content category in the Gallery, you may want to reorganize the category's structure. You can create subcategories and move Gallery items between subcategories.

### To create a subcategory

1. If the Gallery isn't visible, press **Gallery** .
2. Select **My Content** (or one of its subcategories) in the Gallery's category list, press its menu arrow, and then select **New Folder**.

A new subcategory appears.

3. Type a name for the new subcategory, and then press RETURN.

## CHAPTER 6

Inserting, organizing and sharing content

### To rename a subcategory

1. If the Gallery isn't visible, press **Gallery** .
2. Select **My Content** in the Gallery's category list, and then browse to the subcategory that you want to rename.
3. Select the subcategory, press its menu arrow, and then select **Rename**.
4. Type a new name for the subcategory, and then press RETURN.

### To move a Gallery item to a different subcategory

1. If the Gallery isn't visible, press **Gallery** .
2. Browse to the category that contains the Gallery item you want to move.  
  
The Gallery displays the contents of the category.
3. Drag the item to another subcategory.

## Sharing content with other teachers

Importing and exporting collection files is an ideal way to share custom categories with other teachers and to use categories that other teachers have created. You can use collection files to add items to the My Content category in the Gallery. After you import a collection file, all of its items appear in the Gallery as a new subcategory.

### To import a collection file from another teacher

1. If the Gallery isn't visible, press **Gallery** .
2. Select **My Content** (or one of its subcategories) in the Gallery's category list, press its menu arrow, and then select **Add to My Content**.

The *Open* dialog box appears.

3. Browse to the folder that contains the collection file you want to import.



#### NOTE

A collection file has a .gallery extension.

4. Select the collection file, and then press **Open**.

The collection appears as a new subcategory.

### To export a collection file to share with other teachers

1. Select the category that contains the items you want to save in a collection.



#### NOTE

SMART Notebook software exports the selected category but doesn't export any of its subcategories.

2. Press the category's menu arrow, and then select **Export as Collection File**.

The *Save* dialog box appears.

3. Browse to the folder where you want to save the collection file.
4. Type a name for the file in the *Save As* box.
5. Press **Save**.

## Connecting to Team Content categories



The Team Content categories feature enables you to connect to Gallery content in a shared location on your school's network. Multiple teachers can connect to the same folder. SMART Notebook software automatically updates your changes for all other teachers.



#### NOTE

Your access permissions for the Team Content category are the same as your folder access permissions on your school's network. If you have full access to a folder on the network, you can add or remove items in that folder's Team Content category. However, if you have read-only access to the folder, you can copy items from the Team Content category, but you're unable to add, edit or remove items.

### To connect to a Team Content category

1. If the Gallery isn't visible, press **Gallery** .
2. Press **Click here for more Gallery options** , and then select **Connect to Team Content**.  
The *Connect to Team Content* dialog box appears.
3. Browse to and select the folder containing the Team Content category you want to connect to, and then press **Open**.

The Team Content category appears in the Gallery.

## CHAPTER 6

Inserting, organizing and sharing content

### To contribute to a Team Content category

Add content to a Team Content category as you do to the My Content category (see *Adding content to the Gallery* on page 82).

## Sharing content using the SMART Exchange website

In addition to sharing your content with other teachers in your school (see *Sharing content with other teachers* on page 84), you can share .notebook files with teachers from around the world using the SMART Exchange website ([exchange.smarttech.com](http://exchange.smarttech.com)).

### To share a .notebook file on the SMART Exchange website

1. Open the .notebook file you want to share.
2. Select **File > Share on SMART Exchange**.

A dialog box appears.

3. If you're new to the SMART Exchange website, press **Not a member yet**, and then follow the on-screen instructions to create an account.

OR

If you have an account, type your e-mail address in the *Email Address* box and your password in the *Password* box, and then press **Sign In**.



#### TIPS

- If you forgot your password, click **Forgot your password**, and then follow the on-screen instructions to reset it.
- If you don't want to log on to the SMART Exchange website each time you share content, select the **Keep me signed in** check box.

## CHAPTER 6

Inserting, organizing and sharing content

4. Enter the appropriate information:

<b>Control</b>	<b>Instructions</b>
<b>Enter resource details</b>	Type a title for the .notebook file.
<b>Description</b>	Type a description of the .notebook file.
<b>Subject(s)</b>	Select the subjects that the .notebook file is applicable to.
<b>Grade(s)</b>	Select the grades that the .notebook file is applicable to.
<b>Search terms</b>	Type words or phrases that other SMART Exchange users will likely enter to search for the .notebook file. Separate the words or phrases with commas.

5. Read the sharing agreement.
6. If you accept the sharing agreement, press **Agree and Submit**.



# Chapter 7

## Creating lesson activities

Using advanced object features .....	90
Creating custom Creative pen styles .....	90
Adding links to objects .....	92
Adding sounds to objects .....	94
Animating objects .....	96
Locking objects .....	96
Using advanced page features .....	97
Recording pages .....	97
Applying page backgrounds and themes .....	98
Applying backgrounds using the Properties tab .....	98
Applying backgrounds and themes using the Gallery .....	100
Creating themes .....	101
Creating example lesson activities .....	101
Creating a matching lesson activity .....	102
Creating a hide-and-show lesson activity .....	104
Creating a reveal lesson activity .....	106
Creating other types of lesson activities .....	108

---

Using SMART Notebook software, you can not only present information to students but also engage them in interactive lesson activities.

You can create lesson activities by inserting objects such as shapes, pictures and tables, and using features such as the Activity Builder and scaling gesture.

This section documents the advanced features you can use to create lesson activities and shows you how to create a set of example lesson activities. You can use these example lesson activities or develop your own. You can also use resources available to you in the Gallery and SMART Exchange website.

## Using advanced object features

You can use the following advanced object features when creating lesson activities:

- Custom creative pen styles
- Object links
- Object sounds
- Object animation

You can also lock any objects that you don't want moved or otherwise modified during the presentation of a lesson activity.

### Creating custom Creative pen styles

SMART Notebook software includes eight Creative pen styles (see *Writing or drawing digital ink* on page 26). In addition to these styles, you can create your own styles using pictures or objects on the currently selected page.



#### To create a custom Creative pen using a picture

1. Press **Pens** .

The Pens tool buttons appear.

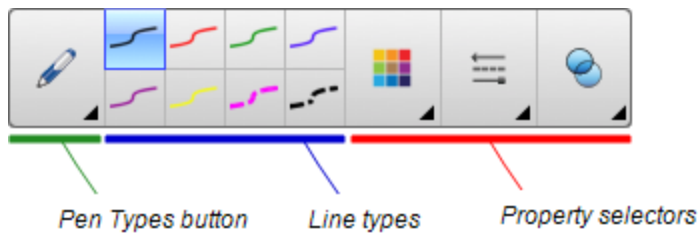

2. Press **Pen Types**, and then select **Creative Pen**.
3. Select a line type.



## CHAPTER 7

### Creating lesson activities

4. If the Properties tab isn't visible, press **Properties** .
5. Press **Line Style**.
6. Select **Use a custom stamp image**.
7. Click **Browse**.

The *Insert Image File* dialog box appears.

8. Browse to and select the picture you want to use for the Creative pen style.
9. Press **Open**.
10. Write or draw digital ink on the page.



#### TIP

- To resume using the default line type, select **Use the default pattern**.
- If you want to save your custom Creative pen style for future use, press **Save Tool Properties**. You can later reset the Creative pen style (see *Customizing the toolbar* on page 141).

### To create a custom Creative pen using an object

1. Press **Pens** .

The Pens tool buttons appear.

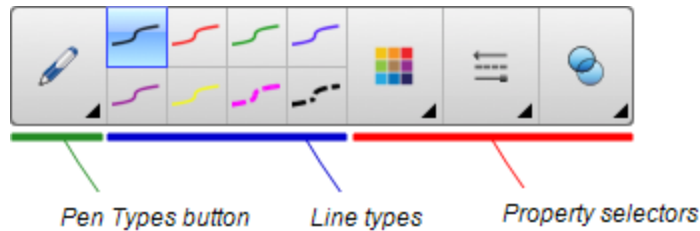

2. Press **Pen Types**, and then select **Creative Pen**.
3. If the Properties tab isn't visible, press **Properties** .
4. Press **Line Style**.
5. Select **Use a custom stamp image**.
6. Press **Select object**, and then select an object on the page.

## CHAPTER 7

### Creating lesson activities

7. Write or draw digital ink on the page.



#### TIP

- To resume using the default line type, select **Use the default pattern**.
- If you want to save your custom Creative pen style for future use, press **Save Tool Properties**. You can later reset the Creative pen style (see *Customizing the toolbar* on page 141).

## Adding links to objects

You can link any object on a page to a web page, another page in the file, a file on your computer or an attachment. An attachment is a copy of a file, a shortcut to a file or a link to a web page that you add to the Attachments tab.



#### NOTE

You can display animated link indicators around all links on a page (see *Displaying links* on page 116).

### To add a link to a web page

1. Select the object.
2. Press the object's menu arrow, and then select **Link**.  
The *Insert Link* dialog box appears.
3. Press **Web Page**, and then type the web address in the *Address* box.
4. If you want to open the link by pressing an icon, select **Corner icon**.

OR

If you want to open the link by pressing anywhere in the object, select **Object**.

5. Press **OK**.

If you selected **Corner icon**, the  icon appears in the lower-left corner of the object.

### To add a link to another page in the file

1. Select the object.
2. Press the object's menu arrow, and then select **Link**.  
The *Insert Link* dialog box appears.
3. Press **Page in this File**, and then select an option in the *Select a page* area.

## CHAPTER 7

### Creating lesson activities

4. If you want to open the link by pressing an icon, select **Corner icon**.

OR

If you want to open the link by pressing anywhere in the object, select **Object**.

5. Press **OK**.

If you selected **Corner icon**, the  icon appears in the lower-left corner of the object.

#### **To add a link to a file on your computer**

1. Select the object.
2. Press the object's menu arrow, and then select **Link**.

The *Insert Link* dialog box appears.

3. Press **File on this Computer**, and then type the file's location and name in the *File* box.
4. If you want to attach a copy of the file, select **Copy of file**.

OR

If you want to insert a shortcut to the file, select **Shortcut to file**.

5. If you want to open the link by pressing an icon, select **Corner icon**.

OR

If you want to open the link by pressing anywhere in the object, select **Object**.

6. Press **OK**.

If you selected **Corner icon**, the  icon appears in the lower-left corner of the object.

#### **To add a link to an attachment**

1. Select the object.
2. Press the object's menu arrow, and then select **Link**.

The *Insert Link* dialog box appears.

3. Press **Current Attachments**, and then select the attachment in the list.
4. If you want to open the link by pressing an icon, select **Corner icon**.

OR

If you want to open the link by pressing anywhere in the object, select **Object**.

5. Press **OK**.

If you selected **Corner icon**, the  icon appears in the lower-left corner of the object.

### To remove a link

1. Select the object.
2. Press the object's menu arrow, and then select **Link**.

The *Insert Link* dialog box appears.

3. Press **Remove Link**.

## Adding sounds to objects

You can add a sound to any object (except Adobe Flash Player compatible files and widgets) by attaching a sound file or recording a sound using a computer microphone. You can play the sound during the lesson by pressing an icon in the corner of the object or the object itself.



### NOTE

SMART Notebook software supports the MP3 audio format. If you want SMART Notebook software to support other file types, you can install additional encoders (see *Installing encoders for additional formats* on page 77).

### To add a sound file to an object

1. Select the object.
2. Press the object's menu arrow, and then select **Sound**.

A dialog box appears.

3. Press **Choose File**.

The *Open* dialog box appears.

4. Browse to and select the sound file, and then press **Open**.
5. Select **Corner Icon** if you want to play the sound file when you press an icon in the object's lower-left corner.

OR

Select **Object** if you want to play the sound file when you press anywhere on the object.

6. Press **Attach Sound**.

### To add a recorded sound to an object

1. Connect a microphone to your computer and turn it on.
2. Select the object.

## CHAPTER 7

### Creating lesson activities

3. Press the object's menu arrow, and then select **Sound**.

A dialog box appears.

4. Click **Start Recording**.
5. Record the sound using the microphone.



#### IMPORTANT

SMART Notebook software stops recording after one minute. Therefore, ensure the sound is no more than one minute long.

6. Click **Stop Recording**.
7. Type a name for the sound in the *Recording name* box.
8. Optionally, click **Preview Recording** to hear the sound before adding it to the object.
9. Select **Corner Icon** if you want to play the sound file when you press an icon in the object's lower-left corner.

OR

Select **Object** if you want to play the sound file when you press anywhere on the object.

10. Press **Attach Recording**.

#### To remove a sound from an object

1. Select the object.
2. Press the object's menu arrow, and then select **Sound**.  
A dialog box appears.
3. Press **Remove Sound**.

## Animating objects

You can animate an object to fly onto a page from the side, spin, fade in, shrink and more. You can set the animation to start when you open a page or when you press the object.

### To animate an object

1. Select the object.
2. If the Properties tab isn't visible, press **Properties** .
3. Press **Object Animation**.
4. Select options in the *Type*, *Direction*, *Speed*, *Occurs* and *Repeats* drop-down lists.

## Locking objects

You can lock an object to prevent its modification, movement or rotation. Alternatively, you can lock an object but allow its movement or its movement and rotation.

You can remove this lock at any time.

### To lock an object

1. Select the object.
2. Press the object's menu arrow, and then select **Lock > Lock in Place**.

You're unable to move, rotate or modify the object until you unlock it.

#### NOTE

If you press a locked object, a lock icon  appears instead of a menu arrow.

### To lock an object but allow its movement

1. Select the object.
2. Press the object's menu arrow, and then select **Lock > Allow Move**.

You can move the object but you're unable to rotate or modify it until you unlock it.

#### NOTE

If you press a locked object, a lock icon  appears instead of a menu arrow.

### To lock an object but allow its movement and rotation

1. Select the object.
2. Press the object's menu arrow, and then select **Lock > Allow Move and Rotate**.

You can move and rotate the object but you're unable to modify it until you unlock it.

#### **NOTE**

If you press a locked object, a lock icon  appears instead of a menu arrow.

### To unlock an object

1. Select the object.
2. Press the object's lock icon , and then select **Unlock**.

## Using advanced page features

You can use the following advanced page features when creating lesson activities:

- Page recording
- Page backgrounds and themes



### Recording pages

The Page Recording options enable you to record your actions on the current page.

#### **NOTE**

SMART Recorder is a different but similar tool. Using SMART Recorder, you can record your actions in programs other than SMART Notebook software. With SMART Recorder, you can record a full screen, specified window or rectangular portion of the screen. If you connect a microphone to your computer, you can also record audio.

### To record a page

1. If the Properties tab isn't visible, press **Properties** .
2. Press **Page Recording**.
3. Press .
- A red circle appears in the upper-left corner of the page.
4. Perform the actions that you want to record on the current page.

## CHAPTER 7

### Creating lesson activities

5. When you finish performing these actions, press  .  
A playback toolbar appears on the page.



#### To play a page recording

1. Display the page.  
If the page includes a page recording, a playback toolbar appears on the page.
2. Press **Play**  .

#### To pause the playback

Press **Pause**  .

#### To stop the playback

Press **Stop**  .

#### To rewind the playback

Press **Rewind**  .

#### To remove a page recording

1. Display the page.  
If the page includes a page recording, a playback toolbar appears on the page.
2. To remove the recording, press **Close**  on the toolbar.

## Applying page backgrounds and themes

You can define the appearance of pages' backgrounds using the Properties tab or the Gallery.

### Applying backgrounds using the Properties tab

You can set a page's background to a solid color, a gradient of two colors, a pattern or a picture using the Properties tab.





**To apply a background**

1. Select **Format > Page > Set Background Fill**.

The Properties tab displays *Fill Effects* options.

2. Select a fill style:

Fill style	Procedure
None (transparent)	Select <b>No fill</b> .
Solid color	<ol style="list-style-type: none"> <li>a. Select <b>Solid fill</b>.</li> <li>b. Do one of the following:                             <ul style="list-style-type: none"> <li>o Select one of the 40 colors in the palette.</li> <li>o Press <b>More</b>, and then select a color in the dialog box.</li> <li>o Press the eyedropper , and then select a color on the screen.</li> </ul> </li> </ol>
Gradient of two colors	<ol style="list-style-type: none"> <li>a. Select <b>Gradient fill</b>.</li> <li>b. For each color, do one of the following:                             <ul style="list-style-type: none"> <li>o Select one of the 40 colors in the palette.</li> <li>o Press <b>More</b>, and then select a color in the dialog box.</li> <li>o Press the eyedropper , and then select a color on the screen.</li> </ul> </li> <li>c. Select an option in the <i>Style</i> drop-down list.</li> </ol>
Pattern	<ol style="list-style-type: none"> <li>a. Select <b>Pattern fill</b>.</li> <li>b. Select a pattern.</li> <li>c. Press <b>Foreground color</b>, select a color in the dialog box, and then press <b>OK</b>.</li> <li>d. Press <b>Background color</b>, select a color in the dialog box, and then press <b>OK</b>.</li> </ol>
Picture	<ol style="list-style-type: none"> <li>a. Select <b>Image fill</b>.</li> <li>b. Press <b>Browse</b>. The <i>Open</i> dialog box appears.</li> <li>c. Browse to and select the picture you want to use as a background, and then press <b>Open</b>.</li> </ol>



**NOTE**

If you insert a large picture, a dialog box may appear and prompt you to either reduce the picture's file size or retain the picture's file size. For more information, see *Setting image optimization preferences* on page 145.

## CHAPTER 7

Creating lesson activities

### To remove a background

1. Select **Format > Page > Set Background Fill**.

The Properties tab displays *Fill Effects* options.

2. Select **No fill**.

### **Applying backgrounds and themes using the Gallery**

You can set a page, all the pages in a group or all the pages in a file using a background or theme from the Gallery.

### To apply a background or theme

1. If the Gallery isn't visible, press **Gallery** .
2. Select **My Content** in the Gallery's category list to view your own backgrounds and themes (see *Creating themes* on the next page).

OR

Select **Gallery Essentials** to view backgrounds and themes you installed with the software.

3. Select **Backgrounds and Themes**.

The Gallery displays thumbnails of the available backgrounds and themes.

4. Press the thumbnail of the theme you want to apply.
5. Press the thumbnail's menu arrow, and then select **Insert in Notebook**.

The *Insert Theme* dialog box appears.

6. Select **Insert theme on all pages** to apply the background or theme to all pages in a file.

OR

Select **Insert theme on all pages of current group** to apply the background or theme to all pages in the current group.

OR

Select **Insert theme on current page only** to apply the background or theme to the current page.

7. Press **Ok**.

### To remove a background or theme

1. Control-click the page.
2. Select **Remove Theme**.

## CHAPTER 7

### Creating lesson activities

3. Select **From All Pages** to remove the background or theme from all the pages to which you applied it.

OR

Select **From Page** to remove the background or theme from the selected page only.

## Creating themes

You can use themes to customize pages. You can create a theme and add it to the Gallery so that it's available in a convenient location. You can then apply this theme to a page, all pages in a group or all pages in a file.

The Gallery also includes some themes.

### To create a theme

1. Select **Format > Theme > Create New Theme**.
2. Type a name for the theme in the *Theme Name* box.
3. Set the background in the same way that you would for a page (see *Applying page backgrounds and themes* on page 98).
4. Add and modify objects on the theme in the same way that you would on a page (see *Creating basic objects* on page 25).
5. Press **Save**.

The theme appears in the *My Content* category of the Gallery.

### To create a theme based on the current page

1. Select **Format > Theme > Create New Theme From Page**.
2. Type a name for the theme in the *Theme Name* box.
3. Press **Save**.

The theme appears in the *My Content* category of the Gallery.

## Creating example lesson activities

This section includes example lesson activities you can create and also explains how to create other types of lesson activities.

## Creating a matching lesson activity

### NOTE

You'll complete the following tasks when creating matching lesson activities:

- Using the Activity Builder
- Adding sounds to objects (see *Adding sounds to objects* on page 94)

The Activity Builder enables you to create matching activities, sorting activities, labeling activities, games and more using your own content.

Using the Activity Builder, you define one object on the page as an activity object. You then define which objects on the page will be accepted and which will be rejected when you drag the objects over the activity object.

### To create a matching lesson activity

1. Create the object you want to use as the activity object and the objects you want to accept or reject when dragged to the activity object.
2. Press **Add-ons** , and then press **Activity Builder**.
3. Select the object you want to use as the activity object, and then press **Edit**.
4. Drag the objects you want to accept to the *Accept these objects* list.

A green check mark  appears beside objects you select to accept.

5. Drag the objects you want to reject to the *Reject these objects* list.

A red X  appears beside objects you select to reject.

### NOTES

- To quickly select any remaining objects on the page to accept or reject, press **Add All Remaining** in the appropriate list.
- To remove an object from a list, drag it to the trash can icon .

6. Press **Done**.

### To change a matching lesson activity's settings

1. Press **Add-ons** , and then press **Activity Builder**.
2. Select the activity object, and then press **Edit**.

#### TIP

If you don't know which object on the page is the activity object, click **Identify**. Blue diagonal lines appear for three seconds over any activity objects on the page.

3. Press **Settings**.
4. Select the desired animation for accepted objects in the first **Animation** drop-down list.
5. Optionally, select the **Also play the object's sound** check box to play sounds attached to accepted objects when they're dragged over the activity object (see *Adding sounds to objects* on page 94).
6. Select the desired animation for rejected objects in the first **Animation** drop-down list.
7. Optionally, select the **Also play the object's sound** check box to play sounds attached to rejected objects when they're dragged over the activity object (see *Adding sounds to objects* on page 94).
8. Press **Done**.

### To present a matching lesson activity

1. Drag the objects (or have students drag the objects) to the activity object.
  - If the object is accepted, the accepted object animation plays (fade out by default).
  - If the object is rejected, the rejected object animation plays (bounce back by default).
2. Press **Add-ons** , press **Activity Builder**, and then press **Reset All** when you're done.

### To remove a matching lesson activity

1. Press **Add-ons** , and then press **Activity Builder**.
2. Select the activity object, and then press **Clear Properties**.

## Creating a hide-and-show lesson activity

 **NOTE**

You'll complete the following tasks when creating hide-and-show lesson activities:

- Moving objects (see *Moving objects* on page 56)
- Locking objects (see *Locking objects* on page 96)
- Resizing objects using the scaling gesture (see *Using the scale gesture* on page 62)

You can hide an object and then reveal it using several techniques:

- Add a Screen Shade to a page. During the presentation, gradually remove the shade to reveal the underlying text and graphics when you're ready to discuss them (see *Using the Screen Shade* on page 118).
- Cover the object with digital ink and then erase the digital ink (see *Writing, drawing and erasing digital ink* on page 26).
- Cover the object with another object and then change the order of the objects in the stack (see *Rearranging stacked objects* on page 59).
- Use the object animation feature (see *Animating objects* on page 96).

Alternatively, you can hide an object behind a locked object and then use the scaling gesture to enlarge and show the hidden object if you're using a SMART interactive product that supports multitouch gestures.

 **To create a hide-and-show lesson activity**

1. Create or insert the object you want to hide.

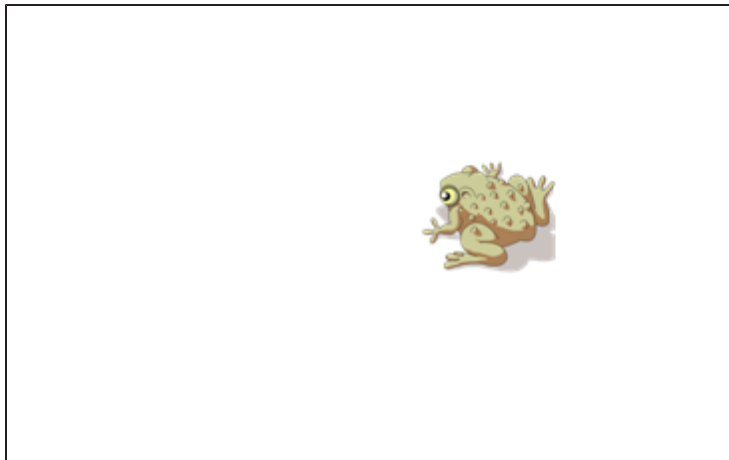

## CHAPTER 7

Creating lesson activities

2. Create or insert the object you want to lock.

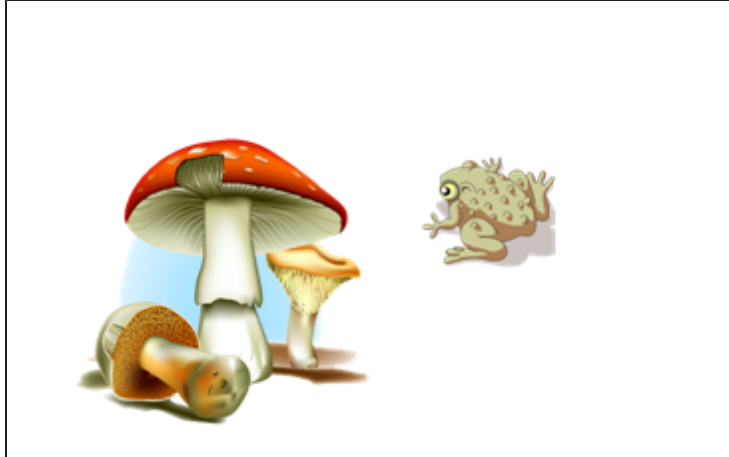

3. Move the object you want to lock so that it covers the object you want to hide.



4. Select the object you want to lock, press its menu arrow, and then select **Locking > Lock in Place**.

## CHAPTER 7

### Creating lesson activities

5. Use the scaling gesture to enlarge and show the hidden object while keeping the locked object in place (see *Using the scale gesture* on page 62).

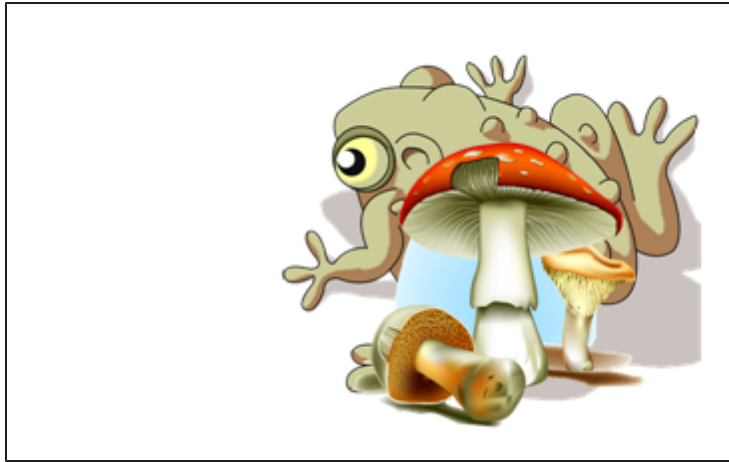

## Creating a reveal lesson activity

### NOTE

You'll complete the following tasks when creating reveal lesson activities:

- Creating tables (see *Creating tables* on page 39)
- Resizing cells (see *Resizing tables, columns or rows* on page 45)
- Filling a table's background with a picture (see *Changing a table's properties* on page 43)
- Adding objects to cells (see *Adding objects to tables* on page 41)
- Adding and removing cell shades (see *Using cell shades* on page 119)

You can use tables and cell shades to create a variety of reveal lesson activities. The following are two examples:

- A puzzle-style reveal lesson activity where you reveal parts of a picture until students can guess what the picture is.

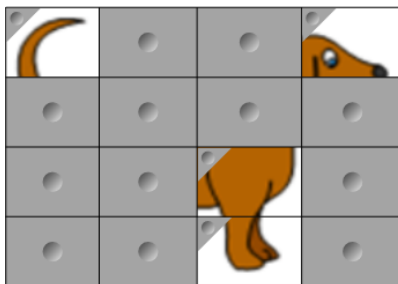



## CHAPTER 7

### Creating lesson activities

- A memory-style reveal lesson activity where you reveal the contents of the cell and then ask students to choose other cells until they find the cell with matching contents.

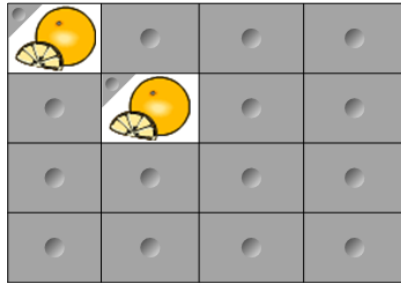

#### **To create a puzzle-style reveal lesson activity**

1. Create a table with the number of cells you want to include in the reveal lesson activity (see *Creating tables* on page 39).
2. Resize the cells as appropriate (see *Resizing tables, columns or rows* on page 45).
3. Select the table, press the table's menu arrow, and then select **Properties**.  
The *Properties* tab appears.
4. Press **Fill Effects**.
5. Select **Image fill**, press **Browse**, browse to and select the picture you want to use in the reveal lesson activity, and then press **Open**.
6. Select **Scale image to fit**.
7. Press the table's menu arrow, and then select **Add Table Shade**.

#### **To create a memory-style reveal lesson activity**

1. Insert the objects you want to include in the lesson activity.
2. Create a table with the number of cells you want to include in the reveal lesson activity (see *Creating tables* on page 39).
3. Resize the cells as appropriate (see *Resizing tables, columns or rows* on page 45).
4. Drag the objects into the cells of the table.
5. Press the table's menu arrow, and then select **Add Table Shade**.

#### **To present a reveal lesson activity**

Press a individual cell's cell shade to reveal the contents of the cell.

To hide the cell behind the cell shade, press  in the corner of the cell.

## CHAPTER 7

### Creating lesson activities

#### Creating other types of lesson activities

The Lesson Activity Toolkit and Lesson Activity Examples in the Gallery include interactive objects you can use to create lesson activities. For more information on the Lesson Activity Toolkit, the Lesson Activity Examples and the Gallery in general, see *Inserting content from the Gallery* on page 70.

The SMART Exchange website includes thousands of lesson plans, question sets and other content that you can download and then open in SMART Notebook software. For more information on the SMART Exchange website, see *Inserting content from the SMART Exchange website* on page 72.

## Chapter 8

# Presenting lesson activities and facilitating collaboration

Preparing before presenting .....	110
Setting the page display .....	110
Zooming in and out .....	111
Panning pages .....	112
Displaying pages in Full Screen view .....	112
Displaying pages in Transparent Background view .....	114
Displaying pages in Dual Page view .....	115
Displaying links .....	116
Moving windows between screens .....	117
Adjusting the volume .....	117
Using presentation tools while presenting .....	118
Using the Screen Shade .....	118
Using cell shades .....	119
Using the Magic Pen .....	119
Selecting the Magic Pen .....	119
Using the Magic Pen to create fading objects .....	120
Using the Magic Pen to open a magnification window .....	120
Using the Magic Pen to open a spotlight window .....	122
Using the Standard pen type to create fading objects .....	123
Using measurement tools .....	123
Using the ruler .....	123
Using the protractor .....	125
Using the Geodreieck protractor .....	128
Using the compass .....	130
Clearing or resetting pages after presenting .....	131
Clearing pages .....	132
Resetting pages .....	133
Enabling two people to use an interactive whiteboard .....	134
Enabling two people to use a SMART Board D600 series interactive whiteboard .....	135
Enabling two people to use a SMART Board 800 series interactive whiteboard .....	135
Selecting tools .....	136

---

## CHAPTER 8

Presenting lesson activities and facilitating collaboration

After creating lesson activities in SMART Notebook software, you can present the lesson activities to students using your interactive product and the presentation features of the software.

In addition to presenting lesson activities to students, you can facilitate collaboration in your classroom using SMART Notebook software and your interactive product. Specifically, you can enable two people to use your SMART Board D600 series or 800 series interactive whiteboard at the same time.

## Preparing before presenting

When you have completed your .notebook files and are ready to present them to students, save the files on a CD, DVD or USB drive. This enables you to access and display the files by inserting the CD, DVD or USB drive into the computer connected to the interactive product. Alternatively, make the files accessible on your local area network, and then browse to them on the interactive product.

Next, prepare for presenting by doing the following:

- Set the page display
- Display any links in the file
- If you have multiple interactive products in your classroom, move windows to the appropriate screens
- If you're presenting video or sound files, adjust the volume

## Setting the page display

You can zoom in and out using the View Screens button or multitouch gestures (if your interactive product supports multitouch gestures).

In addition, SMART Notebook software includes the following views:

- Full Screen view expands the page area to fill the interactive screen by hiding the title bar, toolbar, taskbar and sidebar.
- Transparent Background view enables you to see the desktop and windows behind the SMART Notebook software window and continue to interact with the open, transparent page.
- Dual Page view displays two pages side-by-side.

## CHAPTER 8

Presenting lesson activities and facilitating collaboration

### Zooming in and out

You can zoom in and out using the View Screens button or multitouch gestures (if your interactive product supports multitouch gestures).

#### ■ To zoom in or out using the View Screens button

1. Press **View Screens** .
2. Select a magnification level between 50% and 300%.

OR

Select **Entire Page** to make the entire page fit your display.

OR

Select **Page Width** to set the page's width to the same width as your display.

#### ■ To zoom in or out using multitouch gestures

Drag your fingers in opposite directions to zoom in.

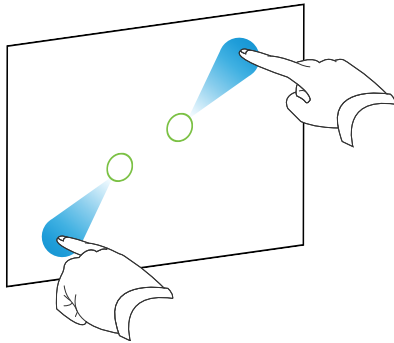

OR

Drag your fingers toward each other to zoom out.

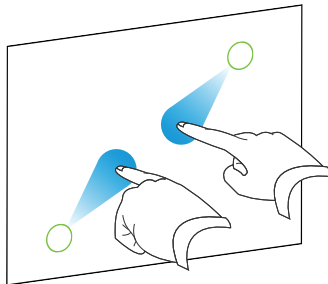

A message appears, displaying the current zoom level.

175%

## CHAPTER 8

Presenting lesson activities and facilitating collaboration

### Panning pages

If your interactive product supports the pan gesture, you can pan a page when zoomed in (see *Zooming in and out* on the previous page).

#### To pan

1. Using two fingers on the same hand, press and hold the screen.
2. Keeping your fingers on the screen, move up, down, left or right.

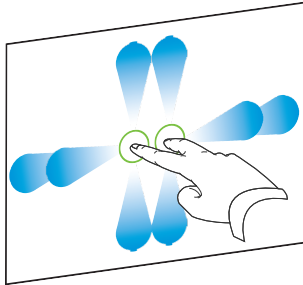

3. When you reach the area you want to view, release your fingers.

### Displaying pages in Full Screen view

In Full Screen view, SMART Notebook software expands the page to fill the screen by hiding the other user interface elements. You can still access commonly used commands using the *Full Screen* toolbar.

#### TIP

Before displaying a page in Full Screen view, select **View > Full Screen Page Border**, and then select the appropriate aspect ratio for your interactive product. A blue line appears, indicating the portion of the page that will appear in Full Screen view without scrolling.







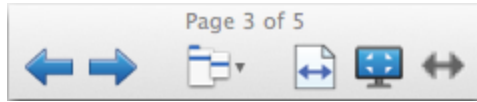

This feature is useful when you're creating content that you want to present in Full Screen view.

**To display a page in Full Screen view**

Press **View Screens** , and then select **Full Screen**.

The page expands to fill the screen, hiding the other user interface elements, and the *Full Screen* toolbar appears.



Button	Command	Action
	Previous Page	Display the previous page in the file.
	Next Page	Display the next page in the file.
	More Options	Open a menu of options.
	Page Width	Change the zoom level to the page's width.
<div data-bbox="722 840 1461 987" data-label="Complex-Block"> <p> <b>TIP</b></p> <p>This is useful if you're using a widescreen interactive product and gray bars appear on the sides of the page.</p> </div>		
	Entire Page	Change the zoom level to Full Page view.
	Exit Full Screen	Return to the standard view.
	Toolbar Options	Display additional toolbar buttons.



 **NOTES**

- The toolbar displays the current page number and the total number of pages in the file.
- If SMART Response software is installed, additional buttons appear that enable you to insert questions and administer assessments.

**To display more toolbar buttons**



Press **Toolbar Options** .

The toolbar expands to include the following buttons:

Button	Command	Action
	Insert Blank Page	Insert a new, blank page in the current file.
	Undo	Reverse the effect of the last action.

## CHAPTER 8

Presenting lesson activities and facilitating collaboration

Button	Command	Action
	Select	Select objects on the current page.
	Magic Pen	Create objects that slowly fade, open a magnification window or open a spotlight window (see <i>Using the Magic Pen</i> on page 119).

### Displaying pages in Transparent Background view

Using Transparent Background view, you can see the desktop and windows behind the SMART Notebook software window and continue to interact with the open, transparent page. You can draw in digital ink on a transparent page and save your notes in the file. You can also display measurement tools, take screen captures and more. If an area of the screen doesn't include any SMART Notebook software objects, you can select and interact with the desktop and applications behind the SMART Notebook software window.





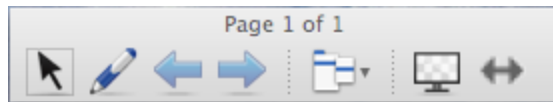

### To display a page in Transparent Background view

Press **View Screens** , and then select **Transparent Background**.

The background of the SMART Notebook software window becomes transparent, enabling you to see the desktop and program behind SMART Notebook software, but any objects on the .notebook file page remain visible.

The *Transparent Background* toolbar appears.



Button	Command	Action
	Select	Select objects on the current page or interact with desktop and application objects that aren't covered by a SMART Notebook software object.
	Pens and Highlighters	Write or draw digital ink on the current page.
	Previous Page	Display the previous page in the current file.
	Next Page	Display the next page in the current file.
	More Options	Open a menu of options that enable you to add a screen shade, select different digital ink, select a Creative pen style, add straight lines, add shapes and more.
	Exit Transparent Background	Return to the standard view.
	Toolbar Options	Display additional toolbar buttons.



## CHAPTER 8

Presenting lesson activities and facilitating collaboration











### NOTES

- The toolbar displays the current page number and the total number of pages in the file.
- If SMART Response software is installed, additional buttons appear that enable you to insert questions and administer assessments.

### To display more toolbar buttons

Press **Toolbar Options** .

The toolbar expands to include the following buttons:

Button	Command	Action
	Insert Blank Page	Insert a new, blank page in the current file.
	Undo	Reverse the effect of the last action.
	Delete	Delete all selected objects.
	Clear Page	Erase all digital ink and delete all objects from the page.
	Screen Capture Toolbar	Open the Screen Capture toolbar.
	Insert Ruler	Insert a ruler on the page (see <i>Using the ruler</i> on page 123).
	Insert Protractor	Insert a protractor on the page (see <i>Using the protractor</i> on page 125).
	Insert Geodreieck Protractor	Insert a Geodreieck protractor on the page (see <i>Using the Geodreieck protractor</i> on page 128).
	Insert Compass	Insert a compass on the page (see <i>Using the compass</i> on page 130).

### Displaying pages in Dual Page view

You can display two pages side-by-side. You can draw, make notes, import files and add links on either page in the same way as you would on a single page.

When you're displaying dual pages, you can pin a page to continue displaying it in the page area while you view other pages in the Page Sorter.

## CHAPTER 8

Presenting lesson activities and facilitating collaboration

### To display a page in Dual Page view

Press **View Screens** , and then select **Dual Page Display**.

A second page appears. A red border indicates the active page.

### To pin a page

1. If you haven't done so already, display dual pages.
2. Select the page you want to continue displaying.
3. Select **View > Dual Page Display > Pin Page**.

Pin icons  appear in the top corners of the pinned page.

### To unpin a page

Clear the selection of **View > Dual Page Display > Pin Page**.

### To return to standard view

Press **View Screens** , and then select **Single Page Display**.

## Displaying links

You can attach a copy of a file, a shortcut to a file, a link to a web page or a sound file to any object on a page (see *Adding links to objects* on page 92). You can display an animated indicator around each object that has a link.

### To display links when a page opens

Select **View > Show All Links When Page Opens**.

Each time you open a page, an animated indicator appears around each object that has a link. Depending on how you define the links, each indicator surrounds either the entire object or an icon in the object's lower-left corner. The indicators disappear automatically after several seconds.

#### NOTE

Clear the selection of **View > Show All Links When Page Opens** to stop displaying links when you open a page.

### To display links on the current page

Select **View > Show All Links**.

An animated indicator appears around each object that has a link. Depending on how you define the links, each indicator surrounds either the entire object or an icon in the object's lower-left corner. The indicators disappear automatically after several seconds.

## Moving windows between screens

You can operate multiple interactive products from the same computer. You can split the computer display over two or more screens, or you can display some programs on one screen and other programs on another. For more information, see *Connecting multiple interactive whiteboards to one computer* ([smarttech.com/kb/000315](http://smarttech.com/kb/000315)).

If you connect multiple interactive products to one computer, you can move windows from one screen to another.

### To move a window from one screen to another

1. If you haven't done so already, display the window.



#### NOTE

You can move a window only if it's neither maximized nor minimized.

2. Press and hold the window on the first screen with your finger.
3. Press the second screen with a finger on your other hand.
4. Lift your finger from the first screen.

The window disappears from the first screen and appears on the second screen.

## Adjusting the volume

If you're presenting a video or sound file and want to adjust volume, you can do so pressing the **Volume Control**  button, and then adjusting your operating system's volume controls.



#### NOTE

Ensure your speakers are turned on.

To add this button to the toolbar, see *Customizing the toolbar* on page 141.

## Using presentation tools while presenting

While presenting lesson activities to students, you can use the following tools:

- Screen Shade
- Cell shades
- Magic Pen
- Standard pen type (to create fading objects)
- Measurement tools
  - Ruler
  - Protractor
  - Geodreieck protractor
  - Compass

### Using the Screen Shade

If you want to cover information and reveal it slowly during a presentation, you can add a Screen Shade to a page.

If you add a Screen Shade to a page and save the file, the Screen Shade appears over the page the next time you open the file.

#### ■ To add a Screen Shade to a page

Press **Show/Hide Screen Shade** .

A Screen Shade appears over the entire page.

#### ■ To reveal part of the page

Drag one of the Screen Shade's resize handles (the small circles at the edges of the Screen Shade).

#### ■ To remove the Screen Shade from a page

Press **Show/Hide Screen Shade** .

OR

Press **Close**  in the upper-right corner of the Screen Shade.

## Using cell shades

You can add a cell shade to a table cell. This enables you to reveal the information in the cells during a presentation.



### NOTES

- You must remove the cell shade if you want to change the cell's properties; insert columns or rows; remove columns, rows or cells; or split or merge cells.
- You can also add a screen shade to cover an entire page (see *Using the Screen Shade* on the previous page).

#### To add a cell shade

1. Select the cell.
2. Press the cell's menu arrow, and then select **Add Cell Shade**.

#### To show and hide the contents of a cell

1. Press the cell shade.  
The cell shade disappears, showing the contents of the cell.
2. Press  in the top-left corner of the cell.  
The cell shade appears, hiding the contents of the cell.

#### To remove a cell shade

1. Select the cell.
2. Press the cell's menu arrow, and then select **Remove Cell Shade**.

## Using the Magic Pen

The Magic Pen enables you to do the following:

- Create an object that slowly fades
- Open a magnification window
- Open a spotlight window

### Selecting the Magic Pen

Before you can use the Magic Pen, you must select it.

### To select the Magic Pen

1. Press **Pens** .

The Pens tool buttons appear.

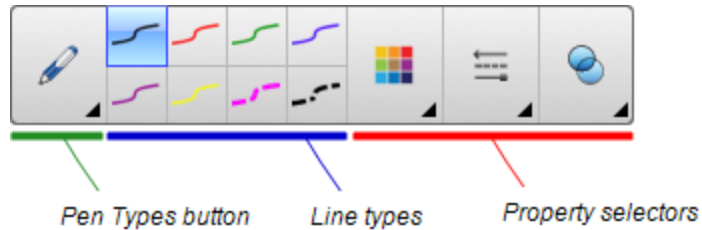

2. Press **Pen Types**, and then select **Magic Pen**.

### Using the Magic Pen to create fading objects

You can create an object that slowly fades using the Magic Pen.

#### NOTE

Fading objects are not saved in .notebook files.

### To create a fading object

1. Select the Magic Pen (see *Selecting the Magic Pen* on the previous page).
2. Using your finger or a pen, write or draw objects on the interactive screen.

The objects slowly fade.

### To set the number of seconds before the object fades

1. Select the Magic Pen (see *Selecting the Magic Pen* on the previous page).
2. If the Properties tab isn't visible, press **Properties** .
3. Press **Fill Effects**.
4. Enter or select the number of seconds before the object fades in the *Fade time* drop-down list.

#### TIP

You can save your changes to the Magic Pen tool's default settings by clicking **Save Tool Properties** (see *Saving tool settings* on page 55).

### Using the Magic Pen to open a magnification window

You can open a magnification window using the Magic Pen.

## CHAPTER 8

Presenting lesson activities and facilitating collaboration

### **To open a magnification window**

1. Select the Magic Pen (see *Selecting the Magic Pen* on page 119).
2. Using your finger or a pen, draw a square or rectangle on the interactive screen.

A magnification window appears.

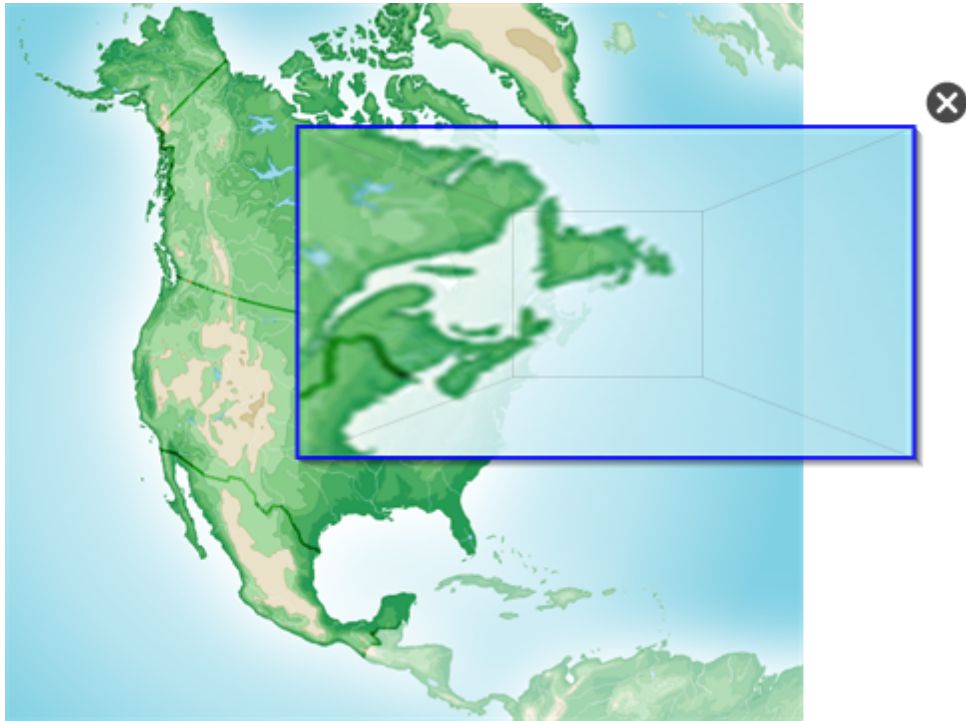

#### **TIP**

You can draw a square but have it fade rather than open a magnification window by using the Standard pen type (see *Using the Standard pen type to create fading objects* on page 123).

3. Do the following:
  - To reduce the magnification window's size, press in the middle of the window, and then drag to the left.
  - To increase the magnification window's size, press in the middle of the window, and then drag to the right.
  - To move the magnification window, press near the edge of the window, and then drag it.
4. Press **Close**  when you're done.

## CHAPTER 8

Presenting lesson activities and facilitating collaboration

### Using the Magic Pen to open a spotlight window

You can open a spotlight window using the Magic Pen.

#### To open a spotlight window

1. Select the Magic Pen (see *Selecting the Magic Pen* on page 119).
2. Using your finger or a pen, draw a circle or ellipse on the interactive screen.

A spotlight window appears.



#### TIP

You can draw a circle but have it fade rather than open a magnification window by using the Standard pen tool (see *Using the Standard pen type to create fading objects* on the next page).

3. Do the following:
  - To reduce the spotlight window's size, press in the middle of the window, and then drag to the left.
  - To increase the spotlight window's size, press in the middle of the window, and then drag to the right.
  - To move the spotlight window, press near the edge of the window, and then drag it.
4. Press **Close**  when you're done.



## Using the Standard pen type to create fading objects

You can create freehand objects that fade after a specified period of time using the Pens tool.

### NOTE

You can also create freehand objects that fade after a specified period of time using the Magic Pen tool (see *Using the Magic Pen to create fading objects* on page 120).

### To write or draw fading digital ink

1. Press **Pens** .

The Pens tool buttons appear.

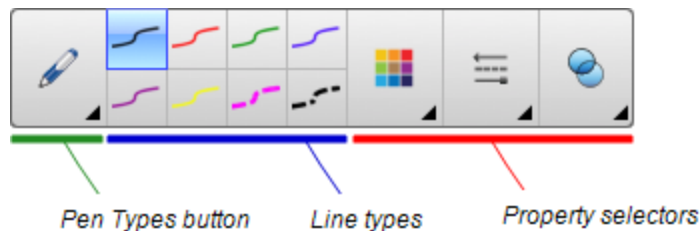

2. Press **Pen Types**, and then select **Pen**.
3. Select a line type.
4. If the Properties tab isn't visible, press **Properties** .
5. Press **Fill Effects**.
6. Select the **Enable ink to fade after you write it** check box, and then enter or select the number of seconds between the time you write or draw the digital ink and the time it fades in the **Fade time** drop-down list.
7. Write or draw digital ink on the page.

## Using measurement tools

Using the SMART Notebook software measurement tools, you can insert a ruler, protractor, Geodreieck protractor or compass into a page.



### Using the ruler

You can insert a ruler into a page, and then manipulate its size, length, rotation and location, and draw along its edges.

## CHAPTER 8

Presenting lesson activities and facilitating collaboration

### To insert a ruler

Press **Measurement Tools** , and then select **Insert Ruler** .

A ruler appears.

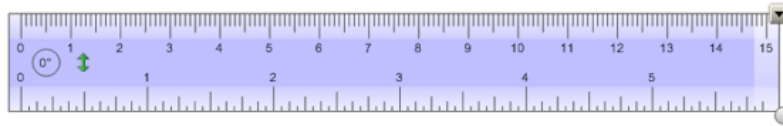

### To move the ruler

Press the middle of the ruler (displayed as a darker shade of blue), and then drag the ruler to a different position on the page.

### To resize the ruler

1. Select the ruler.
2. Drag the ruler's resize handle (the circle in the lower-right corner) to increase or reduce the ruler's size.

### To lengthen the ruler (without changing its scale)

Press the ruler's far edge, between the menu arrow and the resize handle, and then drag away from the ruler.

### To shorten the ruler (without changing its scale)

Press the ruler's far edge, between the menu arrow and the resize handle, and then drag toward the middle of the ruler.

### To rotate the ruler

Press the top or bottom edge of the ruler (displayed as a lighter shade of blue), and then drag the ruler in the direction you want to rotate it.

The ruler displays the current rotation in degrees.

### To reverse the measurements

Press the ruler's flip symbol .

If the metric measurements appeared on the top edge of the ruler, they now appear on the bottom edge and vice versa.

## CHAPTER 8

Presenting lesson activities and facilitating collaboration

### To draw using a pen and the ruler

1. Press **Pens** .

The Pens tool buttons appear.

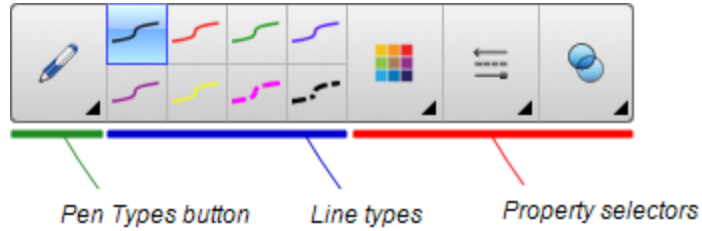

2. Press **Pen Types**, and then select **Pen** or **Calligraphic Pen**.
3. Select a line type.
4. Draw along the edge of the ruler.

Digital ink appears in a straight line along the edge of the ruler.

### To remove the ruler

1. Select the ruler.
2. Press the ruler's menu arrow, and then select **Delete**.

### Using the protractor

You can insert a protractor into a page, manipulate its size, rotation and location, and then draw along its edges.

## CHAPTER 8

Presenting lesson activities and facilitating collaboration

### To insert a protractor

Press **Measurement Tools** , and then select **Insert Protractor** .

A protractor appears.

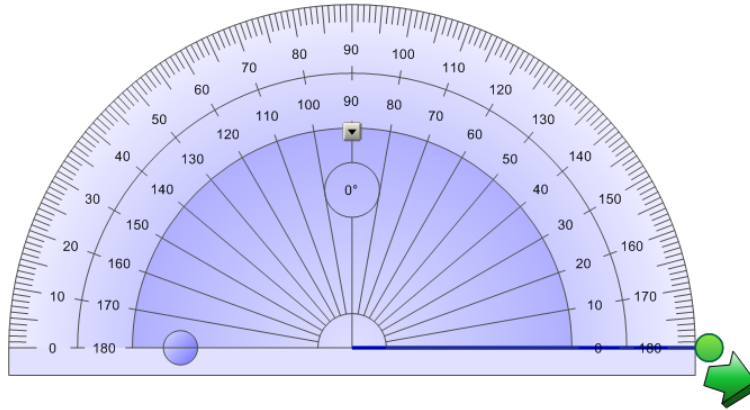

### To move the protractor

Press the inner part of the protractor (displayed as a darker shade of blue), and then drag the protractor to a different position on the page.

### To resize the protractor

Press the inner circle of numbers, and then drag away from the protractor to enlarge it or toward the center of the protractor to shrink it.

### To rotate the protractor

Press the outer circle of numbers, and then drag the protractor in the direction you want to rotate it.

The protractor displays the current rotation in degrees.

## CHAPTER 8

Presenting lesson activities and facilitating collaboration

### To display the protractor as a complete circle

1. Press the blue circle  next to the 180 label on the inner circle of numbers.

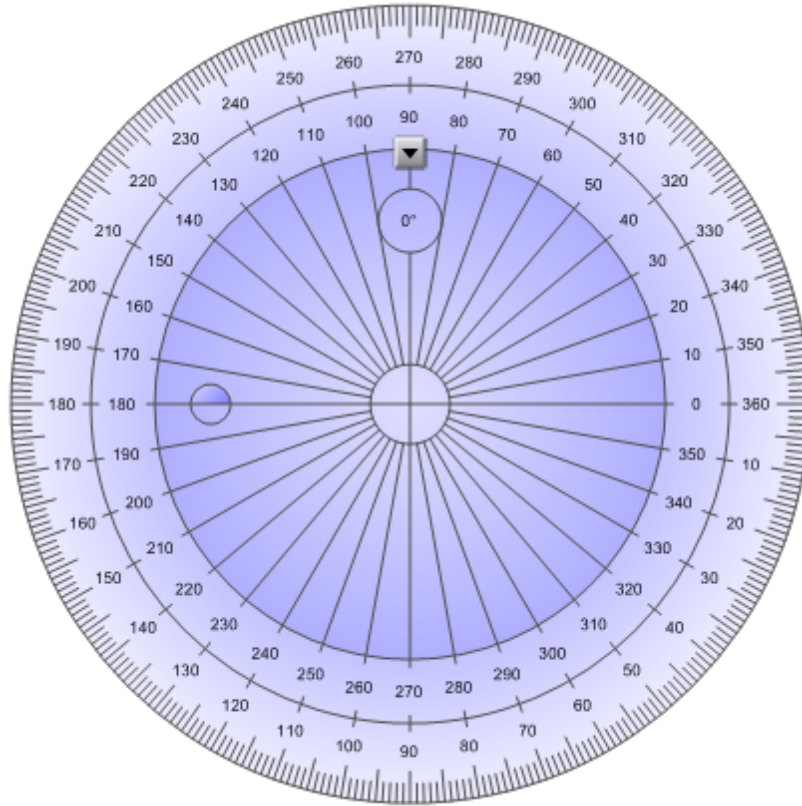

2. Press the blue circle again to return to the semi-circle.

### To draw using a pen and the protractor

1. Press **Pens** .

The Pens tool buttons appear.

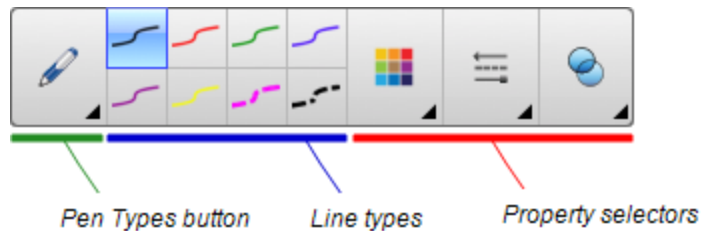

2. Press **Pen Types**, and then select **Pen** or **Calligraphic Pen**.
3. Select a line type.

## CHAPTER 8

Presenting lesson activities and facilitating collaboration

4. Draw along the edge of the protractor.

Digital ink appears in an arc along the edge of the protractor.

### To display angles using the protractor

1. Select the protractor.
2. Drag the green circle until it shows the correct angle for the first of two intersecting lines.
3. Drag the white circle until it shows the correct angle for the second of two intersecting lines.
4. Press the green arrow in the bottom corner.

The lines and the angle between them appear as a separate object.

### To remove the protractor

1. Select the protractor.
2. Press the protractor's menu arrow, and then select **Delete**.

### Using the Geodreieck protractor

You can insert a Geodreieck protractor (also known as a set square or T-square) on a page, and then manipulate its size, rotation and location.

### To insert a Geodreieck protractor

Press **Measurement Tools** , and then select **Insert Geodreieck** .

A Geodreieck protractor appears.

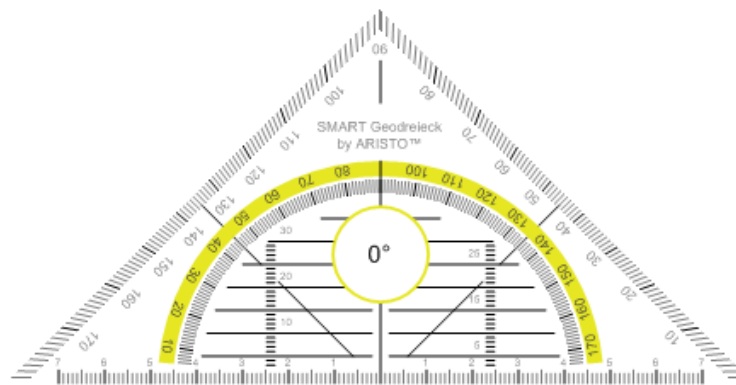

### To move the protractor

Press the inner part of the protractor (within the semi-circle), and then drag the protractor to a different position on the page.

## CHAPTER 8

Presenting lesson activities and facilitating collaboration

### To resize the protractor

Press the semi-circle, and then drag away from the center of the protractor to make it bigger or toward the center of the protractor to make it smaller.

### To rotate the protractor

Press the outer part of the protractor (outside of the semi-circle), and then drag the protractor in the direction you want to rotate it.

The protractor displays the current rotation in degrees.

### To draw using a pen and the Geodreieck protractor

1. Press **Pens** .

The Pens tool buttons appear.

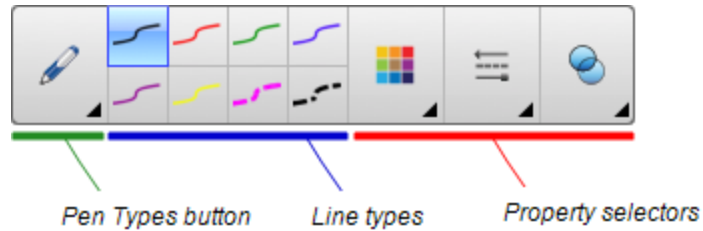

2. Press **Pen Types**, and then select **Pen** or **Calligraphic Pen**.
3. Select a line type.
4. Draw along the edge of the protractor.

Digital ink appears in a straight line along the edge of the protractor.

### To remove the protractor

1. Select the protractor.
2. Press the protractor's menu arrow, and then select **Delete**.

## CHAPTER 8

Presenting lesson activities and facilitating collaboration

### Using the compass

You can insert a compass into a page, manipulate its width, rotation and location, and then use it to draw circles and arcs.

#### ■ To insert a compass

Press **Measurement Tools** , and then select **Insert Compass** .

A compass appears.

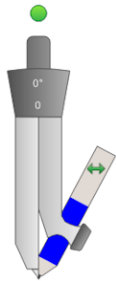

#### ■ To move the compass

Press the arm of the compass that holds the spike, and then drag the compass to a different position on the page.

#### ■ To widen the compass

1. Press the arm of the compass that holds the pen.

Two blue arrows appear.

2. Drag to change the angle between the spike and the pen.

The number on the compass's handle displays the current angle between the spike and the pen.

#### ■ To flip the compass

Press the compass's flip symbol .

The compass's pen appears on the opposite side of the spike.

#### ■ To rotate the compass (without drawing)

Press the compass's rotation handle (the green circle), and then drag the compass in the direction you want to rotate it.



## CHAPTER 8

Presenting lesson activities and facilitating collaboration

### To draw using the compass

1. Press the compass's pen tip.  
The cursor changes to a pen symbol.
2. Drag the compass in the direction you want to rotate it.

### To change the color of the compass's pen

1. Press **Pens** .

The Pens tool buttons appear.

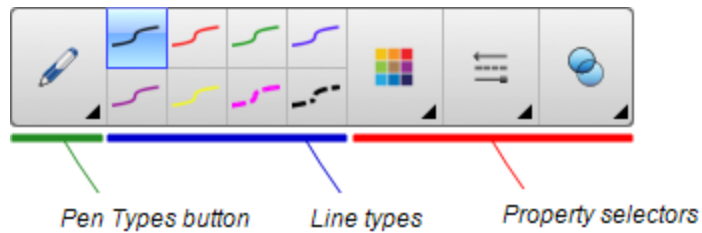

2. Press **Pen Types**, and then select **Pen**.
3. Select a line type.  
The color of the compass's pen changes to display its new color.

### To remove the compass

1. Select the compass.
2. Press the compass's menu arrow, and then select **Delete**.

## Clearing or resetting pages after presenting

After presenting a lesson activity to students, you can clear or reset the pages in your .notebook files to use the files again for future lesson activities.

## CHAPTER 8

Presenting lesson activities and facilitating collaboration

### Clearing pages

You can erase digital ink and delete individual objects from a page. You can also clear all objects or all digital ink objects from a page simultaneously.

#### NOTE

You're unable to clear objects locked in place (see *Locking objects* on page 96) or infinitely cloned objects (see *Cloning objects* on page 60). To clear all objects from a page, you must unlock all locked objects and clear the selection of **Infinite Cloner** on any infinitely cloned objects.

#### To clear all objects from the page

1. If you haven't done so already, display the page you want to clear.
2. Select **Edit > Clear Page**.

#### NOTES

- This option is disabled if there are no objects on the page or if the objects are locked or infinitely cloned.
- You can also select this option by doing one of the following:
  - Control-clicking the page
  - Pressing the page's menu arrow in the Page Sorter
  - Pressing the page's menu arrow while editing page groups (see *Grouping pages* on page 21)
  - Pressing **Clear Page**  if it's included on the toolbar (see *Customizing the toolbar* on page 141)
- You can clear all objects from multiple pages at the same time. Select the pages' thumbnails in the Page Sorter, press the menu arrow, and then select **Clear Page**.

## CHAPTER 8

Presenting lesson activities and facilitating collaboration

### To clear all digital ink objects from the page

1. If you haven't done so already, display the page you want to clear.
2. Select **Edit > Clear Ink from Page**.



#### NOTES

- This option is disabled if there is no digital ink on the page or if the digital ink is locked or infinitely cloned.
- You can also select this option by doing one of the following:
  - Control-clicking the page
  - Pressing the page's menu arrow in the Page Sorter
  - Pressing the page's menu arrow while editing page groups (see *Grouping pages* on page 21)
  - Pressing **Clear Ink**  if it's included on the toolbar (see *Customizing the toolbar* on page 141)
- You can clear all digital ink objects from multiple pages at the same time. Select the pages' thumbnails in the Page Sorter, press the menu arrow, and then select **Clear Ink from Page**.

## Resetting pages

If you make changes to a page (without saving those changes), you can reset the page to the state it was in before you made the changes.



#### NOTE

Resetting a page doesn't reset any Adobe Flash Player compatible files running on the page.

### To reset a page

1. If you haven't done so already, display the page you want to reset.
2. Select **Edit > Reset Page**.

A dialog box appears, prompting you to confirm the reset.



#### NOTES

- This option is disabled if you haven't made changes to the page since last saving the file.
- You can also select this option by doing one of the following:
  - Control-clicking the page
  - Pressing the page's menu arrow in the Page Sorter
  - Pressing the page's menu arrow while editing page groups (see *Grouping pages* on page 21)
  - Pressing **Reset Page**  if it's included on the toolbar (see *Customizing the toolbar* on page 141)
- You can reset multiple pages at the same time. Select the pages' thumbnails in the Page Sorter, press the menu arrow, and then select **Reset Page**.

3. Press **Reset Page**.

## Enabling two people to use an interactive whiteboard

If you have a SMART Board D600 or 800 series interactive whiteboard, two people can create and manipulate objects in SMART Notebook software at the same time. How the two people do this depends on whether you have a SMART Board D600 series interactive whiteboard or a SMART Board 800 series interactive whiteboard.

Allowing two people to use an interactive whiteboard is useful in scenarios such as the following:

- Two students work on an assignment on the interactive whiteboard at the same time
- A teacher and student work on an assignment on the interactive whiteboard at the same time
- A teacher or student poses questions or problems on the interactive whiteboard, and another student responds to these questions or problems

## Enabling two people to use a SMART Board D600 series interactive whiteboard

If you're using a SMART Board D600 series interactive whiteboard, two users can use the interactive whiteboard simultaneously when SMART Notebook software is in Dual-User mode. In Dual-User mode, the screen is divided in half. Each user can press his or her half of the screen with a finger to left-click or drag objects, write using a pen tray pen and erase digital ink using the eraser. Each user can also access frequently used tools using his or her own Floating Tools toolbar.

You can press a toolbar button to switch between Single-User mode and Dual-User mode.

### To display a file in Dual-User mode

Press **View Screens** , and then select **Dual Write Mode**.

### To return to Single-User mode

Press **Exit** .

## Enabling two people to use a SMART Board 800 series interactive whiteboard

If you're using a SMART Board 800 series interactive whiteboard, two people can create and manipulate objects in SMART Notebook software at the same time. Both people can create and manipulate objects in any area of the SMART Notebook software page. Neither user is restricted to a particular section of the page.

Dual-user collaboration mode is enabled when you pick up a pen from the pen tray. One user creates or manipulates objects with his or her finger ("the touch user"). The other user creates or manipulates objects with the pen ("the pen user").

### **NOTE**

In addition to enabling one touch user and one pen user to use the interactive whiteboard at the same time, you can enable two pen users or two touch users to use the interactive whiteboard at the same time. However, the two users must use the same tool.

## CHAPTER 8

Presenting lesson activities and facilitating collaboration

### Selecting tools

To change tools or to set properties for touch, the touch user must press the appropriate button on the toolbar or control in the Properties tab with his or finger. The following is an example:



To change tools or to set properties for the pen, the pen user must press the appropriate button on the toolbar or control in the Properties tab with the pen. The following is an example:



### NOTES

- If the pen user presses a button on the toolbar or sets a property with his or finger instead of the pen, SMART Notebook software changes the selected tool or property for the touch user rather than the pen user.
- When both the touch user and the pen user select multiple objects on the screen, the dashed border of the objects selected by the touch user will be a different color than the dashed border of the object selected by the pen user.

## Chapter 9

# Enhancing SMART Notebook software with add-ons

Installing add-ons .....	137
Using add-ons .....	138
Identifying missing add-ons .....	138
Disabling and removing add-ons .....	139

---

Add-ons are extensions to SMART Notebook software created by SMART Technologies and by third-party software developers.

SMART Notebook software includes the Activity Builder add-on (see *Creating a matching lesson activity* on page 102) and the Alignment Tools add-on (see *Aligning objects* on page 57). You can install other add-ons from the SMART Exchange website to add specialized features to the software. In addition, you can manage all installed add-ons using the Add-on Manager.

## Installing add-ons

You can search for, browse and install add-ons from the SMART Exchange website.

### To install an add-on

1. Select **Add-ons > Manage Add-ons**.

The Add-on Manager appears.

2. Press **Find More**.

The SMART Exchange website opens in your web browser.

## CHAPTER 9

Enhancing SMART Notebook software with add-ons

3. If you're new to the SMART Exchange website, press **Join for free**, and then follow the on-screen instructions to create an account.

OR

If you have an account, press **Sign In**, and then follow the on-screen instructions to log on to the SMART Exchange website with your account.

4. Search or browse for an add-on, and then download it to a temporary location on your computer.
5. Double-click the add-on file.
6. Follow the on-screen instructions to install the add-on.

## Using add-ons

After installing an add-on, you can use the features of that add-on like any other features in SMART Notebook software.

### ■ To view an add-on

1. Press **Add-ons** .
2. Press the add-on's icon.

### ■ To view an add-on's version and other information

1. Select **Add-ons > Manage Add-ons**.

The Add-on Manager appears.

2. Press the add-on's name.
3. Press **About**.

## Identifying missing add-ons

If you open a page in a .notebook file that requires an add-on that isn't installed or is disabled on your computer, a message appears at the top of the page. Press the message to open the Add-on Manager. The Add-on Manager identifies which add-on is required. You can then install that add-on (see *Installing add-ons* on the previous page) or enable it (see *Disabling and removing add-ons* on the next page).



## Disabling and removing add-ons

In some situations, you might want to disable or remove a previously installed add-on.

If you choose to disable an add-on, the add-on no longer appears in SMART Notebook software but is still installed on your computer. You can subsequently enable the add-on.

If you choose to remove an add-on, the add-on no longer appears in SMART Notebook software and is removed from your computer.

### To disable an add-on

1. Select **Add-ons > Manage Add-ons**.

The Add-on Manager appears.

2. Press the add-on's name.
3. Press **Disable**.



#### TIP

To enable the add-on again, press **Enable**.

### To remove an add-on

1. Select **Add-ons > Manage Add-ons**.

The Add-on Manager appears.

2. Press the add-on's name.
3. Press **Remove**.



#### NOTE

You're unable to remove the Activity Builder add-on and the Alignment Tools add-on.



## Chapter 10

# Maintaining SMART Notebook software

Customizing the toolbar .....	141
Configuring SMART Notebook software .....	143
Setting gesture preferences .....	143
Setting hardware acceleration preferences .....	144
Setting image optimization preferences .....	145
Manually reducing the size of large pictures .....	145
Exporting optimized files .....	146
Setting default background color preferences .....	147
Setting measurement tool preferences .....	147
Setting table cell padding preferences .....	149
Setting the language .....	150
Removing SMART software .....	150
Updating and activating SMART software .....	151
Updating SMART software .....	151
Activating SMART software .....	153
Purchasing a product key .....	153
Activating SMART software with a product key .....	153
Sending feedback to SMART .....	155

---

This chapter explains how to maintain SMART Notebook software.

## Customizing the toolbar

The SMART Notebook software toolbar enables you to select and use a variety of commands and tools. You can customize the toolbar so that it includes the tools you use most frequently.

After adding or removing toolbar buttons, you can restore the default set of toolbar buttons. You can also restore the tools' default settings if you customized and saved the settings using the Properties tab (see *Saving tool settings* on page 55).

**To add or remove toolbar buttons**

1. Click **Customize the toolbar** .  
OR  
Right-click the toolbar.  
A dialog box appears.
2. Press **Actions** or **Tools**.
3. Do the following:
  - To add a button to the toolbar, press its icon in the dialog box, and then drag it to the toolbar.
  - To remove a button from the toolbar, press its icon in the toolbar, and then drag it away from the toolbar.
  - To rearrange the buttons, press an icon in the toolbar, and then drag it to a new position in the toolbar.



**NOTES**

- You can only add, remove and rearrange buttons in the panel of the toolbar you selected in step 2. For example, if you pressed **Actions** in step 2, you can only add, remove and rearrange buttons in the *Actions* panel.
- To span a button across rows, drag and hold it between two columns of buttons.



If you're using a smaller screen resolution, only span one or two buttons across rows to prevent issues when the toolbar is wider than the SMART Notebook software window.

4. Press **Done**.

**To restore the default set of toolbar buttons**

1. Click **Customize the toolbar** .  
OR  
Right-click the toolbar.  
A dialog box appears.
2. Press **Restore Default Toolbar**.

### To restore the tools' default settings

1. Click **Customize the toolbar** .  
OR  
Right-click the toolbar.  
A dialog box appears.
2. Press **Restore Default Tool Properties**.

## Configuring SMART Notebook software

This section explains how to configure SMART Notebook software.

### Setting gesture preferences

You can interact with objects in SMART Notebook software using gestures, including the shake gesture and the press-and-hold gesture.

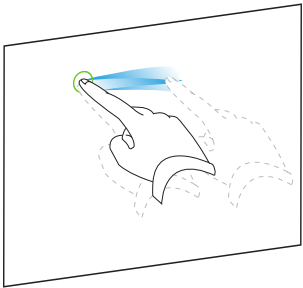
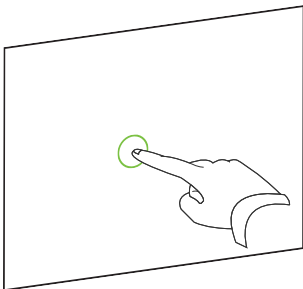
Gesture	Name	Purpose
	Shake gesture	Group two or more objects.
	Press-and-hold gesture	Perform a Control-click.

The shake and press-and-hold gestures are enabled by default. However, you can choose to disable them if you find that you or your students frequently invoke the gestures by accident.

### To disable the shake gesture

1. Select **Notebook > Preferences**.  
A dialog box appears.
2. Press **General**.
3. Clear the **Use the shake gesture to group and ungroup objects** check box.
4. Press **OK**.

### To disable the press-and-hold gesture

1. Select **Notebook > Preferences**.  
A dialog box appears.
2. Press **General**.
3. Clear the **Press and hold to perform a right-click** check box.
4. Press **OK**.

## Setting hardware acceleration preferences

Through hardware acceleration, SMART Notebook software completes some tasks using your computer's graphics processing unit (GPU) rather than its central processing unit (CPU). Hardware acceleration improves the performance of SMART Notebook software on most computers. However, hardware acceleration can cause issues on some computers, such as content not displaying correctly and SMART Notebook software not responding. If you are encountering these issues, you can disable hardware acceleration.

### To disable hardware acceleration

1. Select **Notebook > Preferences**.  
A dialog box appears.
2. Press **General**.
3. Clear the **Use hardware acceleration to increase the speed of SMART Notebook software** check box.
4. Press **OK**.

## Setting image optimization preferences

If your .notebook files contain large pictures (pictures over 1 MB in file size), your files could open and run slowly. You can reduce the pictures' file size without noticeably reducing their quality. As a result, your .notebook files' overall file sizes will be smaller and the files will open and run more quickly.

### To set image optimization preferences

1. Select **Notebook > Preferences**.

A dialog box appears.

2. Press **Defaults**.

3. Select one of the following options in the *Image optimization* drop-down list:

- **Ask every time I insert a large image** to have the option of reducing or not reducing large pictures' file sizes when you insert them.
- **Never change the resolution of inserted images** to never reduce large pictures' file sizes when you insert them.
- **Always change image resolution to optimize file size** to always reduce large pictures' file sizes when you insert them.

4. Press **OK**.

### **Manually reducing the size of large pictures**

If you selected **Ask every time I insert a large image** in the *Image Optimization* drop-down list, you can manually reduce the size of large pictures when you insert those pictures in your file or afterwards.

### To reduce the size of a large picture when inserting it in a file

1. Insert the picture as described in *Inserting pictures* on page 73.

After you press **Open**, the *Image Optimization* dialog box appears.

2. Press **Optimize** to reduce the picture's file size.

OR

Press **Keep Resolution** to not reduce the picture's file size.



### NOTES

- When you insert a BMP file, SMART Notebook software internally converts the file to PNG format. This conversion reduces the size of the file. As a result, you might not need to export an optimized version of the .notebook file (see *Exporting optimized files* below) even if the BMP file is over 1 MB in size.
- SMART Notebook software automatically reduces the file size of pictures over 5 MB or 5 megapixels regardless of which option you choose.

### To reduce the size of a large picture after inserting it in a file

1. Select the picture.
2. Press the picture's menu arrow, and then select **Image Optimization**.

The *Image Optimization* dialog box appears.

3. Click **Optimize**.

### Exporting optimized files

If you have existing files that contain large pictures or if you chose **Never change the resolution of inserted images** in the *Image Optimization* drop-down list, you can export optimized versions of your files that contain reduced pictures. This is particularly useful when you need to present a .notebook file on an older or less powerful computer.

### To export an optimized file

1. Select **File > Export As > Optimized SMART Notebook File**.

A dialog box appears.

2. Browse to where you want to save the new file.
3. Type a name for the file in the *Save As* box.
4. Press **Save**.



## Setting default background color preferences

By default, new pages added to your file have a default white background color. You can change the default background color.



### NOTE

This setting only affects new pages, and will be overridden by any applied Themes.

### To change the default background color

1. Select **Notebook > Preferences**.  
A dialog box appears.
2. Press **Defaults**.
3. Select **Change Color**, and then select a color.
4. Press **OK**.

## Setting measurement tool preferences

By default, the ruler, protractor and Geodreieck protractor in SMART Notebook software are blue and display best with light-colored backgrounds.

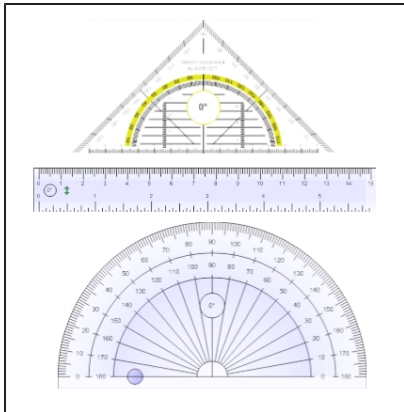

## CHAPTER 10

### Maintaining SMART Notebook software

You can change these measurement tools' color to yellow if you want to use them with dark-colored backgrounds.

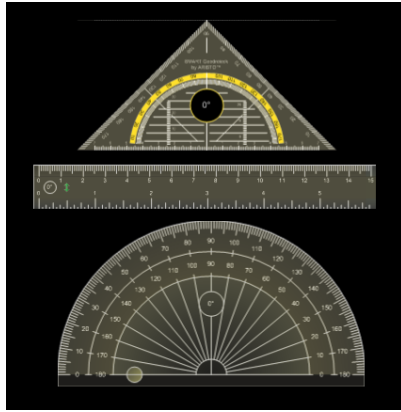

#### NOTE

Completing the following procedure affects the appearance of measurement tools in .notebook files when viewed on your copy of SMART Notebook software only. If you open the same .notebook files on another copy of SMART Notebook software, the measurement tools could display in a different color.

#### To change the measurement tools' color

1. Select **Notebook > Preferences**.

A dialog box appears.

2. Press **Defaults**.
3. Select **Blue tint (recommended for light backgrounds)** in the *Measurement tool color* drop-down list to set the measurement tools' color to blue.

OR

Select **Yellow tint (recommended for dark backgrounds)** in the *Measurement tool color* drop-down list to set the measurement tools' color to yellow.







4. Press **OK**.

## Setting table cell padding preferences

SMART Notebook 11 software adds cell padding to tables.

*Table before upgrading to  
SMART Notebook 11 software  
(without cell padding)*

*Table after upgrading to  
SMART Notebook 11 software  
(with cell padding)*

Complete the following procedure to remove cell padding from tables. This is particularly useful if you created tables prior to upgrading to SMART Notebook 11 software and intended the tables' contents to display without cell padding.



### NOTE

Completing the following procedure affects the appearance of tables in .notebook files when viewed on your copy of SMART Notebook software only. If you open the same .notebook files on another copy of SMART Notebook software, the tables display with cell padding (assuming the procedure hasn't been completed on that copy of SMART Notebook software).

### To remove cell padding from tables

1. Select **Notebook > Preferences**.  
A dialog box appears.
2. Press **Defaults**.
3. Clear the **Add cell padding to table cells** check box.
4. Press **OK**.
5. Close and restart SMART Notebook software.

New and existing tables in your .notebook files display without cell padding.

## Setting the language

You can set the language for the SMART applications installed on your computer using the international system preferences.



### NOTE

This procedure may vary depending on your version of Mac OS X operating system software.

### To set the language

1. Select **Apple > System Preferences**.  
The *System Preferences* window appears.
2. Press **International**.
3. Press **Language**.
4. Drag the appropriate language to the top of the *Languages* list.



### NOTE

The SMART applications installed on your computer may not support all languages in the *Languages* list. The system administrator's guide for each SMART application lists the supported languages.

5. Close the **System Preferences** window.

## Removing SMART software

SMART Support might ask you to remove existing versions of SMART software before you install new versions. You can do this using the SMART Uninstaller.

### To remove SMART software

1. In Finder, browse to and double-click  
**Applications/SMART Technologies/SMART Uninstaller**.

2. Select the software you want to remove.



#### NOTES

- Some SMART software is dependent on other SMART software. For example, if you select **SMART Notebook**, SMART Uninstaller removes SMART Response software automatically because SMART Response software is dependent on SMART Notebook software.
- SMART Uninstaller automatically removes any supporting software that is no longer being used. If you choose to remove all SMART software, SMART Uninstaller automatically removes all supporting software, including itself.



#### TIPS

- To select more than one software application, hold down SHIFT or COMMAND while selecting the software applications.
- To select all software applications, press **Select All**.

3. Press **Remove**, and then press **OK**.
4. If prompted, enter a user name and password with administrator privileges, and then press **OK**.  
SMART Uninstaller removes the selected software.
5. Close SMART Uninstaller when done.

## Updating and activating SMART software

After you install SMART software, you need to activate it. After you activate the software, you need to install updates from SMART.



#### IMPORTANT

To update and activate SMART software, you need to be connected to the Internet.

### Updating SMART software

SMART periodically releases updates to its software and firmware products. (Firmware is software installed in hardware products like the SMART Board interactive whiteboard.) You can use SMART Product Update (SPU) to check for and install these updates.

Your system administrator can install SPU in Full mode or Dashboard mode. In Full mode, you can view installed versions and download and install updates as documented in this section. In Dashboard mode, you can only view installed versions.

### To check for updates automatically

1. In Finder, browse to and double-click **Applications/SMART Technologies/SMART Tools/SMART Product Update**.

The *SMART Product Update* window appears.

2. Select the **Check for updates automatically** check box, and then type the number of days (up to 60) between SPU checks.
3. Close the *SMART Product Update* window.

If an update is available the next time SPU checks, the *SMART Product Update* window appears automatically and the *Update* button of the affected product is enabled.

### To check for updates manually

1. In Finder, browse to and double-click **Applications/SMART Technologies/SMART Tools/SMART Product Update**.

The *SMART Product Update* window appears.

2. Press **Check Now**.

If an update is available for a product, its *Update* button is enabled.

3. If an update is available, install it by following the next procedure.

### To install an update

1. Open the *SMART Product Update* window as described in the previous procedures.
2. Press the product's row.

Product details appear. These product details include the installed version's number and the update's number, date and download size (if an update is available).

#### TIP

Press **View release notes** to view a summary of the changes in the update and the computer requirements for the update.

3. Press **Update**.
4. Follow the on-screen instructions to download and install the update.

#### IMPORTANT

To install updates, you must have full administrator access.

### To disable automatic checking for updates

1. In Finder, browse to and double-click **Applications/SMART Technologies/SMART Tools/SMART Product Update**.

The *SMART Product Update* window appears.

2. Clear the **Check for updates automatically** check box.



#### IMPORTANT

SMART recommends that you do not clear this check box.

## Activating SMART software

Typically, you activate SMART software after installing it. However, in some situations, you activate the software later. For example, you could be evaluating the software before deciding to purchase it.



#### NOTES

- As of version 11.1, you don't need to activate SMART Notebook software or SMART Product Drivers. SMART provides you with the right to use this software when you purchase a SMART interactive product.
- If you want to use SMART Notebook software with a device that isn't a SMART interactive product, you must purchase a product key.

### Purchasing a product key

For some SMART products, you must purchase a product key from your authorized SMART reseller ([smarttech.com/wheretobuy](http://smarttech.com/wheretobuy)).



#### TIPS

- After obtaining a product key, record it in a safe place for future reference.
- If you lose your product key, go to [smarttech.com/findproductkey](http://smarttech.com/findproductkey).

### Activating SMART software with a product key

After obtaining a product key, you can activate SMART software.

### To activate SMART software

1. In Finder, browse to and double-click **Applications/SMART Technologies/SMART Tools/SMART Product Update**.

The *SMART Product Update* window appears.

2. Press **Activate** or **Manage** for the software you want to activate.

The *SMART Software Activation* window appears.

**NOTE**

The value in the *Status* column indicates the status for each product:

<b>Value</b>	<b>Description</b>
<i>Installed</i>	The software is installed.
<i>Activated</i>	The software is installed and activated with a perpetual or maintenance license.
<i>Subscription</i>	The software is installed and activated with a subscription license. The number in parentheses indicates the days remaining in the subscription period.
<i>Expiring</i>	The software is installed but not yet activated. The number in parentheses indicates the days remaining in the evaluation period.
<i>Expired</i>	The software is installed but not yet activated. The evaluation period is over. You're unable to use the software until you activate it.
<i>Unknown</i>	The software's status is unknown.

3. Press **Add**.
4. Follow the on-screen instructions to activate the software using the product key.

### To view product keys

1. In Finder, browse to and double-click **Applications/SMART Technologies/SMART Tools/SMART Product Update**.

The *SMART Product Update* window appears.

2. Select **Tools > View Product Keys**.

The *Product Keys* dialog box appears.

3. Press **OK** when you're done viewing the product keys.

**NOTE**

Alternatively, you can view the product keys for a single product by pressing the product's name in the *SMART Product Update* window, and then pressing **View product key**.



## Sending feedback to SMART

When you start SMART software for the first time, a dialog box could appear asking whether you want to join the SMART Customer Experience Program. If you choose to join the program, the software sends information to SMART that helps us improve the software for future releases. After starting the software for the first time, you can enable or disable this feature through the *Help* menu.

You can also send feature request e-mails to SMART.

### ■ To enable the Customer Experience Program tracking feature

Select **Notebook > Customer Experience Program > Feedback tracking ON**.

### ■ To disable the Customer Experience Program tracking feature

Select **Notebook > Customer Experience Program > Feedback tracking OFF**.

### ■ To send a feature request e-mail

1. Select **Notebook > Submit Feature Request**.

A new e-mail message appears in your default e-mail program.

2. Type your request in the new e-mail message, and then press **Send**.



# Chapter 11

## Troubleshooting SMART Notebook software



Troubleshooting files .....	157
Troubleshooting the SMART Notebook software window and toolbar .....	157
Troubleshooting digital ink .....	158
Troubleshooting objects .....	159
Troubleshooting gestures .....	160

This chapter explains how to troubleshoot issues with SMART Notebook software.

### Troubleshooting files

Issue	Recommendation
Your file contains large pictures and runs slowly when you open it in SMART Notebook software.	Export an optimized version of the file (see <i>Setting image optimization preferences</i> on page 145).

### Troubleshooting the SMART Notebook software window and toolbar



Issue	Recommendation
When using SMART Notebook software on an interactive product, you or your students can't reach the toolbar.	<p>Press <b>Move toolbar to top/bottom of window</b>  to move the toolbar from the top of the window to the bottom.</p> <div style="background-color: #f0f0f0; padding: 5px;"> <p> <b>TIP</b></p> <p>If you have a height-adjustable wall mount, you can also adjust the height of your interactive whiteboard or display so that students can reach it.</p> </div>

Issue	Recommendation
<p>Toolbar buttons described in this documentation don't appear on the toolbar.</p>	<p>If a down arrow ▼ appears on the right side of the toolbar, press it to display additional toolbar buttons.</p> <p>If your desired button doesn't appear when you click the down arrow ▼, you or another user might have removed the button (see <i>Customizing the toolbar</i> on page 141).</p> <p>Don't span more than a few buttons across rows to prevent the toolbar from being wider than the SMART Notebook software window.</p>
<p>There isn't enough room on your interactive product to display the contents of a page.</p>	<p>Press <b>View Screens</b> , and then select <b>Full Screen</b> to display the page in Full Screen mode.</p> <p>OR</p> <p>Select the <b>Auto-hide</b> check box to hide the tabs when not in use.</p>
<p>The Page Sorter, Gallery, Attachments, Properties and other tabs disappear whenever you press outside of the tabs.</p>	<p>Press one of the tab's icons to display it, and then clear the <b>Auto-hide</b> check box.</p>
<p>Two users are creating or manipulating objects in SMART Notebook software on a SMART Board 800 series interactive whiteboard. One user is using his or her finger. The other user is using a pen from the pen tray. When the user using the pen presses a button in the toolbar, the selected tool or option changes for the user using his or her finger instead.</p>	<p>The user using the pen must press buttons in the toolbar with the pen, not with his or her finger.</p> <p>For more information, see <i>Enabling two people to use a SMART Board 800 series interactive whiteboard</i> on page 135.</p>

## Troubleshooting digital ink

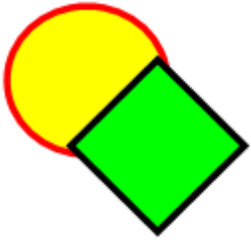
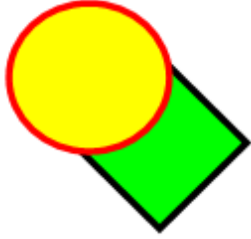

Issue	Recommendation
<p>You want your handwriting to appear more smooth and natural in SMART Notebook software.</p>	<p>Use the Calligraphic pen type rather than the Standard pen type (see <i>Writing or drawing digital ink</i> on page 26).</p> <div style="background-color: #f0f0f0; padding: 5px; border: 1px solid #ccc;"> <p> <b>NOTE</b></p> <p>The Calligraphic pen type is available only if your computer is connected to a SMART interactive product.</p> </div>

## Troubleshooting objects

Issue	Recommendation
<p>When you create a .notebook file on one computer and then open it on another computer, the objects in the file appear differently.</p>	<p>There are several possible causes. The following are the most common:</p> <ul style="list-style-type: none"> <li>• You used a font that's installed on one computer but not on the other.</li> <li>• The two computers have different operating systems.</li> <li>• The two computers have different versions of SMART Notebook software.</li> </ul>
<p>You want to move, resize or otherwise change an object, but when you do so, you also move, resize or otherwise change other objects.</p>	<p>The objects are grouped. Any changes you make to one object affect the other objects. Select the objects, and then select <b>Format &gt; Group &gt; Ungroup</b> to ungroup them. You can then move, resize or otherwise change the individual objects.</p> <p>For more information, see <i>Grouping objects</i> on page 65.</p>
<p>You want to move, resize or otherwise change an object but can't. A lock icon  appears instead of a menu arrow when you select the object.</p>	<p>The object is locked, which prevents you from making changes to it. To unlock the object, select it, press its lock icon , and then select <b>Unlock</b>.</p> <p>For more information, see <i>Locking objects</i> on page 96.</p>
<p>One object on a page covers another:</p>  <p>You want to change this so that the second object covers the first:</p> 	<p>As you create objects, newer objects cover older objects automatically if the objects are in the same position on the page.</p> <p>You can change the order of objects. For more information, see <i>Rearranging stacked objects</i> on page 59.</p>

## CHAPTER 11

### Troubleshooting SMART Notebook software

Issue	Recommendation
<p>When you fill an object with a picture that is larger than the object, the picture is cut off:</p>  <p>Conversely, when you fill an object with a picture that is smaller than the object, the picture is tiled:</p> 	<p>When filling an object with a picture, select <b>Scale image to fit</b> to resize the picture to fit the object:</p>  <p>For more information, see <i>Changing objects' properties</i> on page 52.</p>

## Troubleshooting gestures

Issue	Recommendation
<p>The multitouch gestures described in this guide aren't working in SMART Notebook software.</p>	<p>Ensure that your interactive product supports multitouch gestures and that multitouch gestures are enabled.</p>

# Index

## A

- activation 153
- Activity Builder 102
- add-ons
  - about 137
  - disabling 139
  - identifying missing 138
  - installing 137
  - removing 139
  - using 138
- Adobe Flash Player compatible files 74
- Adobe Flash video files 76
- AIFF files 77
- aliases 80
- animation 96
- arcs 31-32
- arrows 29
- ASF files 77
- attachments 80
- audio encoders 77
- audio files See sound files
- automatic tasks
  - grouping objects 66
- AVI files 77

## B

- backgrounds 98
- BMP files 13, 73, 146
- bold text 35

## C

- Calligraphic pen type 26
- cell padding 149

- CFF files 14, 78
- check marks 29
- circles 29, 31
- cloning
  - objects 60
  - pages 19
- compasses 130
- content
  - inserting in .notebook files 69
  - organizing 83
  - sharing with other teachers 84
- CPUs 144
- Crayon pen type 26
- Creative pen type 27, 90
- crosses 29
- Customer Experience Program 155

## D

- diamonds 29
- digital ink
  - about 26
  - converting to text 33
  - erasing 28
  - troubleshooting 158
  - writing or drawing 26
- document cameras 73
- downloads 77
- drop cap 35
- Dual-User mode 135
- Dual Page view 115

## E

- encoders 77
- eraser 28

## INDEX

Essentials for Educators See Gallery  
Essentials  
exports 13, 85

## F

fading objects 120, 123  
feature request e-mails 155  
feedback 155  
ffmpegX 77  
files  
    attaching to .notebook files 80  
    creating 11  
    cutting, copying, and pasting content from 77  
    displaying in Dual-User mode 135  
    displaying in Dual Page view 115  
    displaying in Full Screen view 112  
    displaying in Transparent Background view 114  
    exporting 13  
    importing 78  
    linking to objects 93  
    opening 11  
    printing 15  
    reducing size of 145  
    saving 12  
    troubleshooting 157  
Flash files See Adobe Flash Player  
    compatible files  
Flash video files See Adobe Flash video  
    files  
footers 14-15  
freehand objects See digital ink  
Full Screen view 112

## G

Gallery  
    adding themes to 101  
    adding your content to 82  
    applying backgrounds and themes from 100  
    exporting content from 85

    finding and working with content from 70  
    importing content to 84  
    organizing your content in 83  
Gallery Essentials 70  
Gallery Sampler See Lesson Activity  
    Examples  
Geodreieck protractors 128  
gestures  
    about 8  
    setting preferences for 143  
    troubleshooting 160  
    types of  
        flick 56  
        panning 112  
        pinch to zoom 111  
        rotate 64  
        scale 62  
        shake 66, 143  
        swipe 17  
GIF files 73  
GPUs 144  
graphics See pictures  
groups  
    object 65, 159  
    pages 21

## H

handouts 15  
handwriting, conversion to text of 33  
hardware acceleration 144  
headers 14-15  
heptagons 30  
hexagons 29-30  
highlighter 27  
HTML files 13

## I

images See pictures  
imports 78, 84  
Interactive Whiteboard Common File  
    Format 14, 78



## INDEX

Internet browsers 78  
invisible areas See transparent areas  
italicized text 35

## J

JPEG files 13, 73

## L

languages 33, 150  
Lesson Activity Examples 70  
Lesson Activity Toolkit 70  
lines 32  
links  
    adding to objects 92  
    showing 116  
Linux operating systems 12  
locked objects 96, 159

## M

Mac OS X operating system software 12  
Magic pen tool 27  
Magic Pen tool 119  
magnification 111, 120  
mathematical symbols 37  
measurement tools  
    about 123  
    setting preferences for 147  
    types of  
        compass 130  
        Geodreieck protractor 128  
        protractor 125  
        rulers 123  
menu arrows 50  
MOV files 77  
MP3 files See sound files  
MP4 files 77  
MPEG files 77  
multimedia files 74  
multiple interactive products 117  
music files See sound files

My Content category 83, 85, See  
    also Team Content categories

## N

names  
    of files 12, 146  
    of page groups 21  
    of pages 20  
.notebook file format 12  
Notebook software See SMART Notebook

## O

objects  
    adding links to 92  
    adding to tables 41  
    adding to the Gallery 82  
    aligning 57  
    animating 96  
    clearing all from a page 132  
    cloning 60  
    cutting, copying and pasting 59  
    deleting 67  
    erasing 28  
    fading 120, 123  
    flipping 65  
    grouping 65  
    locking 96  
    moving 56  
    moving to other pages 57  
    rearranging 59  
    resizing 61  
    resizing text 36  
    rotating 63  
    selecting 50  
    setting fill and line style for 52  
    troubleshooting 159  
octagons 30  
online resources 72  
ovals 31

## P

padding 149

page numbers 14-15

pages

- adding to the Gallery 82
- clearing 132
- cloning 19
- creating 18
- deleting 22
- displaying 17
- displaying in Dual-User mode 135
- displaying in Dual Page view 115
- displaying in Full Screen view 112
- displaying in Transparent Background view 114
- extending 19
- grouping 21
- hiding with Screen Shades 118
- linking to objects 92
- moving objects between 57
- panning 112
- pinning 115
- printing 15
- rearranging 20
- recording 97
- renaming 20
- setting backgrounds for 98
- zooming in and out 111

panning 112

parallelograms 29

PDF files

- exporting 14

pens

- types of
  - Calligraphic 26
  - Crayon 26
  - Creative 27, 90
  - Highlighter 27
  - Magic 27, 119
  - Shape Recognition 27, 31
  - Standard 26

pentagons 29-30

performance, improving 144

photographs See pictures

pictures

- about 73
- creating transparent areas in 74
- exporting files to 14
- inserting from a SMART Document Camera 73
- inserting from files 73
- reducing file sizes of 145

PNG files 13, 73

polygons 30

PowerPoint 41

preferences

- gestures 143
- hardware acceleration 144
- image optimization 145
- measurement tools 147
- table cell padding 149

Preferences

- new page default color 147

printers 15

product keys 153

protractors 125

proxy servers 79

## Q

QuickTime files See MOV files

## R

rectangles 29, 31

regular polygons 30

resize handle 61

rulers 123

## S

Screen Shades 118-119

set squares See Geodreieck protractors

Shape Recognition Pen tool 27, 31

## INDEX

shapes  
    about 29  
    creating with the Regular Polygons tools 30  
    creating with the Shape Recognition Pen tool 31  
    creating with the Shapes tool 29  
shortcuts See aliases  
Single-User mode 135  
SMART Board 800 series interactive whiteboards 135  
SMART Board D600 series interactive whiteboards 135  
SMART Board Tools 2  
SMART Document Cameras 73  
SMART Exchange 72, 86, 137  
SMART Ink  
    about 2  
SMART Notebook 2  
SMART Product Drivers 2  
SMART Product Update 151  
SMART Uninstaller 150  
sound files 94, 117  
spell checker 37  
spotlight 122  
squares 29-31  
stacks of objects 59  
straight lines 32  
SWF files See Adobe Flash Player compatible files

## T

T-squares See Geodreieck protractors  
tables  
    about 39  
    adding cell shades to 119  
    adding columns, rows or cells to 46  
    adding objects to 41  
    changing properties for 43  
    creating 39  
    moving 43  
    removing 48  
    removing cell padding from 149

    removing cell shades from 119  
    removing columns, rows or cells from 46  
    selecting 42  
    splitting or merging cells in 47  
Team Content categories See also My Content category  
text  
    checking spelling of 37  
    converting handwriting to 33  
    cutting 38  
    editing 34  
    including mathematical symbols in 37  
    resizing 36  
    typing 33  
themes  
    applying 100  
    creating 101  
thumbnails  
    in printouts 15  
    in the Page Sorter 17  
TIFF files 13  
toolbars  
    Full Screen 113  
    SMART Notebook 141, 157  
    Transparent Background 114  
transparent areas 74  
Transparent Background view 114  
trapezoids 29  
triangles 29-31  
troubleshooting  
    digital ink 158  
    files 157  
    gestures 160  
    objects 159  
    SMART Notebook software window and toolbar 157

## U

underlined text 35  
updates 151

## INDEX

### V

video encoders 77  
videos 76  
volume 117

### W

WAV files 77  
web browsers See Internet browsers  
web pages 13, 81, 92  
widgets 72  
Windows Media files 77  
Windows operating systems 12  
Word 41

### X

XBK files 11

### Z

zooming in and out 111, 120



SMART Technologies

[smarttech.com/support](https://smarttech.com/support)

[smarttech.com/contactsupport](https://smarttech.com/contactsupport)

[smarttech.com/kb/170615](https://smarttech.com/kb/170615)