



# SMART Notebook® 14 software

## USER'S GUIDE

FOR WINDOWS OPERATING SYSTEMS

**SMART**®

## Product registration

If you register your SMART product, we'll notify you of new features and software upgrades.

Register online at [smarttech.com/registration](http://smarttech.com/registration).

Keep the following information available in case you need to contact SMART Support.

Serial number:

---

Date of purchase:

---

### Trademark notice

SMART Notebook, SMART Document Camera, SMART Ink, SMART Board, SMART Response, SMART Exchange, smarttech, the SMART logo and all SMART taglines are trademarks or registered trademarks of SMART Technologies ULC in the U.S. and/or other countries. Windows, PowerPoint and Internet Explorer are either registered trademarks or trademarks of Microsoft Corporation in the U.S. and/or other countries. Mac, Mac OS, OS X and QuickTime are trademarks of Apple Inc., registered in the U.S. and other countries. Adobe, Reader and Flash are either registered trademarks or trademarks of Adobe Systems Incorporated in the U.S. and/or other countries. GeoGebra is a registered trademark of GeoGebra Inc. All other third-party product and company names may be trademarks of their respective owners.

### Copyright notice

© 2014 SMART Technologies ULC. All rights reserved. No part of this publication may be reproduced, transmitted, transcribed, stored in a retrieval system or translated into any language in any form by any means without the prior written consent of SMART Technologies ULC. Information in this manual is subject to change without notice and does not represent a commitment on the part of SMART.

This product and/or use thereof covered by one or more of the following U.S. patents.

[www.smarttech.com/patents](http://www.smarttech.com/patents)

12/2014

# Contents

<b>Chapter 1: Getting started with SMART Notebook software</b> .....	<b>1</b>
About SMART Notebook software .....	2
About the other SMART software on your computer .....	2
What's new .....	3
Starting SMART Notebook software .....	4
Navigating the user interface .....	5
Viewing tool change notifications .....	11
Using gestures .....	12
Undoing and redoing actions .....	13
<b>Chapter 2: Creating and working with files</b> .....	<b>15</b>
Creating files .....	15
Opening files .....	15
Saving files .....	16
Exporting files .....	17
Printing files .....	19
Saving files automatically .....	20
Attaching files to e-mail messages .....	24
<b>Chapter 3: Creating and working with pages</b> .....	<b>25</b>
Displaying pages in a file .....	25
Creating pages .....	26
Cloning pages .....	27
Extending pages .....	27
Renaming pages .....	28
Cutting or copying and pasting pages .....	28
Rearranging pages .....	29
Grouping pages .....	30
Deleting pages .....	31
<b>Chapter 4: Creating basic objects</b> .....	<b>33</b>
Writing, drawing and erasing digital ink .....	34
Creating shapes and lines .....	37
Creating text .....	41
Creating tables .....	48
<b>Chapter 5: Working with objects</b> .....	<b>59</b>
Selecting objects .....	60
Changing objects' properties .....	62

## CONTENTS

Positioning objects .....	65
Cutting, copying and pasting objects .....	69
Cropping images with a mask .....	70
Cloning objects .....	72
Resizing objects .....	72
Rotating objects .....	75
Flipping objects .....	77
Grouping objects .....	77
Deleting objects .....	79
<b>Chapter 6: Inserting, organizing and sharing content .....</b>	<b>81</b>
Inserting content from the Gallery .....	82
Inserting content from GeoGebra .....	84
Inserting content from the SMART Exchange website .....	85
Inserting content from other sources .....	86
Inserting equations with the Math Editor .....	96
Inserting Internet browsers .....	98
Attaching files and web pages .....	99
Organizing and sharing content using the Gallery .....	101
Sharing content using the SMART Exchange website .....	106
<b>Chapter 7: Creating lesson activities .....</b>	<b>107</b>
Using advanced object features .....	108
Using advanced page features .....	115
Creating example lesson activities .....	121
<b>Chapter 8: Presenting lesson activities and facilitating collaboration .....</b>	<b>129</b>
Preparing before presenting .....	130
Using presentation tools while presenting .....	139
Clearing or resetting pages after presenting .....	174
Enabling two people to use an interactive whiteboard .....	177
<b>Chapter 9: Enhancing SMART Notebook software with add-ons .....</b>	<b>181</b>
Installing add-ons .....	181
Using add-ons .....	182
Identifying missing add-ons .....	183
Disabling and removing add-ons .....	183
Accessing XC Collaboration .....	184
<b>Chapter 10: Accessing RSS feeds with SMART Connect .....</b>	<b>185</b>
Finding, adding and deleting an RSS feed .....	185
Viewing RSS feed content .....	186
Bookmarking articles .....	187
Inserting images and video in the drawing area .....	188

CONTENTS

**Chapter 11: Maintaining SMART Notebook software .....189**

- Customizing the toolbar ..... 189
- Configuring SMART Notebook software ..... 191
- Setting the language .....198
- Removing SMART software .....199
- Updating and activating SMART software .....200
- Sending feedback to SMART ..... 205

**Chapter 12: Troubleshooting SMART Notebook software .....207**

- Troubleshooting files ..... 207
- Troubleshooting the SMART Notebook software window and toolbar ..... 207
- Troubleshooting digital ink ..... 208
- Troubleshooting objects .....209
- Troubleshooting gestures .....211

**Index ..... 213**



## Chapter 1

# Getting started with SMART Notebook software

About SMART Notebook software .....	2
About the other SMART software on your computer .....	2
What's new .....	3
SMART Notebook 14.3 software .....	3
SMART Notebook 14.2 software .....	3
SMART Notebook 14.1 software .....	4
SMART Notebook 14 software .....	4
Starting SMART Notebook software .....	4
Navigating the user interface .....	5
Menu .....	5
Toolbar .....	5
Actions panel .....	5
Plug-ins panel .....	5
Tools panel .....	5
Contextual panel .....	6
Customizing the toolbar .....	6
Page Sorter .....	6
Opening the Page Sorter .....	7
Customizing the Page Sorter .....	7
Gallery tab .....	7
Opening the Gallery tab .....	7
Customizing the Gallery tab .....	8
Attachments tab .....	8
Opening the Attachments tab .....	8
Customizing the Attachments tab .....	8
Properties tab .....	8
Opening the Properties tab .....	9
Customizing the Properties tab .....	9
Add-ons tab .....	9
Opening the Add-ons tab .....	9
Customizing the Add-ons tab .....	9
SMART Response tab .....	10

---

Page area .....	10
Viewing tool change notifications .....	11
Using gestures .....	12
Undoing and redoing actions .....	13

---

This chapter introduces you to SMART Notebook® collaborative learning software and explains how to get started with the software.

## About SMART Notebook software

In SMART Notebook software, you can create .notebook files that include graphics, text, tables, lines, shapes, animations and more. Present your file and keep your class's attention as you move and interact with these objects. When your class provides comments and suggestions, write their input on the page using digital ink. You can open .notebook files in SMART Notebook software on a Windows®, Mac or Linux® computer. You can also export your file in a variety of formats, including HTML and PDF.

You can install SMART Notebook Tools as well as third-party add-ons to add special features to SMART Notebook software. SMART Notebook Tools include the following:

- 3D Tools for SMART Notebook software
- Mixed Reality Tools for SMART Document Camera™
- SMART Notebook Math Tools

## About the other SMART software on your computer

Your computer might include the following other SMART software.

- **SMART Product Drivers**

Your interactive product detects contact with its screen and sends each contact point, along with Pen tool information, to the connected computer. SMART Product Drivers translates the information into mouse clicks and digital ink. SMART Product Drivers enables you to perform normal computer operations by using your finger or a pen.

- **SMART Ink™**

Using SMART Ink, you can write or draw on the screen in digital ink using a pen, and then save or erase your notes.



- **SMART Board® Tools**

You can draw attention to specific parts of a page using SMART Board Tools, such as the Screen Shade, Spotlight, Magnifier and Pointer.

## What's new

SMART Notebook 2014 software introduces the following new features.

### SMART Notebook 14.3 software

Feature	Topic
Lesson Recorder provides an easy way to record activities on a SMART Notebook software page.	<i>Recording pages with the Lesson Recorder</i> on page 139
You can link any object to a tool on your software toolbar to create a customized tool that you can place anywhere on your page.	<i>Linking objects to tools</i> on page 150
You can cut or copy and paste a page using the Page Sorter.	<i>Cutting or copying and pasting pages</i> on page 28
You can use the Text Pen to do the following: <ul style="list-style-type: none"><li>- Insert text in a different color</li><li>- Change the color of selected text</li><li>- Change the color of a whole world</li></ul>	<i>Editing with the Text Pen</i> on page 148
You can lock an object but allow it to move horizontally or vertically.	<i>Locking objects</i> on page 114
The screen shade is available in multiple colors.	<i>Using the Screen Shade</i> on page 141
The picture transparency dialog box is resizable.	<i>Creating transparent areas in a picture</i> on page 87

### SMART Notebook 14.2 software

Feature	Topic
SMART Blocks	<i>Using SMART Blocks</i> on page 152

Feature	Topic
You can use colored ink to write equations in the Math Editor.	<i>Inserting equations with the Math Editor</i> on page 96

### SMART Notebook 14.1 software

Feature	Topic
Math Editor	<i>Inserting equations with the Math Editor</i> on page 96
Tool change notifications	<i>Viewing tool change notifications</i> on page 11

### SMART Notebook 14 software

Feature	Topic
Paint Brush pen type	<i>Writing or drawing digital ink</i> on page 34
Crop images	<i>Cropping images with a mask</i> on page 70
Notebook Connect	<i>Accessing RSS feeds with SMART Connect</i> on page 185
GeoGebra add-on	<i>Inserting content from GeoGebra</i> on page 84
Ink editing	<i>Using the Text Pen</i> on page 147
XC Collaboration add-on	<i>Accessing XC Collaboration</i> on page 184
Calligraphic pen type	<i>Writing or drawing digital ink</i> on page 34

## Starting SMART Notebook software

Start SMART Notebook software by double-clicking the **SMART Notebook** icon on the desktop.

When you start SMART Notebook software the first time, a tutorial file opens automatically. You can read the contents of this file to learn more about the software and the new features in the latest release. When you're done, select **File > New** to create a new, blank file.

#### NOTE

When you start the software subsequent times, a new, blank file opens automatically. To open the tutorial file, select **Help > Tutorial**.

## Navigating the user interface

The SMART Notebook software user interface consists of the following components:

- Menu
- Toolbar
- Tabs (Page Sorter, Gallery, Attachments, Properties, Add-ons and SMART Response®)
- Page area

### Menu

The menu contains all the commands you can use to manipulate files and objects in SMART Notebook software.

### Toolbar

The toolbar enables you to select and use a variety of commands. The buttons on the toolbar are organized in panels.

#### Actions panel

The *Actions* panel of the toolbar includes buttons that enable you to browse and make changes to .notebook files:



#### Plug-ins panel

If you install SMART Notebook Tools such as SMART Notebook Math Tools and SMART Response software, an additional panel appears to the right of the *Actions* panel:



#### Tools panel

The *Tools* panel includes buttons that enable you to create and work with basic objects on pages:



### Contextual panel

When you select one of the buttons in the *Tools* panel, additional buttons appear. For example, if you select **Pens** , the following additional buttons appear:

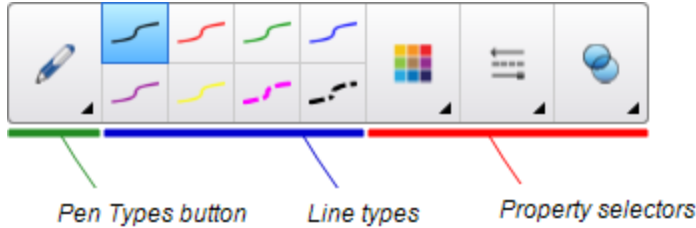



Press the **Pen Types** button to select a pen type and then press one of the line type buttons to write or draw digital ink in that line type. You can customize a selected line type using the options in the Properties tab and then save your changes for future use (see *Saving tool settings* on page 65).

The three property selectors beside the line type buttons enable you to set the color, thickness, style and transparency of digital ink.

If you click any of the other buttons in the *Tools* panel, similar sets of additional buttons appear.

### Customizing the toolbar

You can add, remove and change the position of buttons on the toolbar by pressing **Customize the toolbar**  (see *Customizing the toolbar* on page 189).

By default, the toolbar appears at the top of the SMART Notebook software window. However, you can move it to the bottom of the window by pressing **Move toolbar to top/bottom of window** . This is useful in situations where you or your students can't reach the toolbar when it's at the top of the window.

### Page Sorter

The Page Sorter displays all of the pages in the open file as thumbnails and automatically updates these thumbnails as you change the contents of the pages.

Using the Page Sorter, you can do the following:

- Cut or copy and paste pages
- Display pages
- Cutting, copying, pasting pages
- Create pages

- Clone pages
- Clear pages
- Delete pages
- Rename pages
- Rearrange pages
- Move objects from one page to another
- Group pages

### Opening the Page Sorter

To open the Page Sorter, press **Page Sorter** .

### Customizing the Page Sorter

You can move the Page Sorter from one side of the SMART Notebook software window to the other by pressing **Move Sidebar** .

You can resize the Page Sorter by dragging its border left or right. You can also hide the Page Sorter when you aren't using it by selecting the **Auto-hide** check box. (To display the Page Sorter when it's hidden, press **Page Sorter** .)

#### NOTE

If you reduce the Page Sorter to its minimum size, the auto-hide feature turns on automatically.

## Gallery tab

The Gallery tab contains clip art, backgrounds, multimedia content, files and pages that you can use in your lessons, and displays preview images of this content. The Gallery tab also provides access to other online resources. For more information, see *Inserting content from the Gallery* on page 82.

You can also include your own content and content from other teachers in your school in the Gallery tab (see *Organizing and sharing content using the Gallery* on page 101).

### Opening the Gallery tab

To open the Gallery tab, press **Gallery** .

### Customizing the Gallery tab

You can move the Gallery tab from one side of the SMART Notebook software window to the other by pressing **Move Sidebar** .

You can resize the Gallery tab by dragging its border left or right. You can also hide the Gallery tab when you aren't using it by selecting the **Auto-hide** check box. (To display the Gallery tab when it's hidden, press **Gallery** .)

#### NOTE

If you reduce the Gallery tab to its minimum size, the auto-hide feature turns on automatically.

### Attachments tab

The Attachments tab displays the files and web pages attached to the current file. For more information, see *Attaching files and web pages* on page 99.

#### Opening the Attachments tab

To open the Attachments tab, press **Attachments** .

#### Customizing the Attachments tab

You can move the Attachments tab from one side of the SMART Notebook software window to the other by pressing **Move Sidebar** .

You can resize the Attachments tab by dragging its border left or right. You can also hide the Attachments tab when you aren't using it by selecting the **Auto-hide** check box. (To display the Attachments tab when it's hidden, press **Attachments** .)

#### NOTE

If you reduce the Attachments tab to its minimum size, the auto-hide feature turns on automatically.

### Properties tab

The Properties tab enables you to format objects on a page, including digital ink, shapes, lines, text and tables. Depending on the object you select, you can change the following:

- The color, thickness and style of lines
- The transparency and fill effects of objects

- The font type, size and style of text
- The animation of objects

The Properties tab displays only the options that are available for the object you select. For more information on displaying and setting object properties in the Properties tab, see *Changing objects' properties* on page 62.

The Properties tab also includes a **Page Recording** button. You can use this feature to record your actions on the current page (see *Recording pages with the Lesson Recorder* on page 139).

### Opening the Properties tab

To open the Properties tab, press **Properties** .

### Customizing the Properties tab

You can move the Properties tab from one side of the SMART Notebook software window to the other by pressing **Move Sidebar** .

You can resize the Properties tab by dragging its border left or right. You can also hide the Properties tab when you aren't using it by selecting the **Auto-hide** check box. (To display the Properties tab when it's hidden, press **Properties** .)

#### NOTE

If you reduce the Properties tab to its minimum size, the auto-hide feature turns on automatically.

## Add-ons tab

The Add-ons tab enables you to work with SMART Notebook software add-ons (see *Enhancing SMART Notebook software with add-ons* on page 181).

### Opening the Add-ons tab

To open the Add-ons tab, press **Add-ons** .

### Customizing the Add-ons tab

You can move the Add-ons tab from one side of the SMART Notebook software window to the other by pressing **Move Sidebar** .

You can resize the Add-ons tab by dragging its border left or right. You can also hide the Add-ons tab when you aren't using it by selecting the **Auto-hide** check box. (To display the Add-ons tab when it's hidden, press **Add-ons** .)

 **NOTE**

If you reduce the Add-ons tab to its minimum size, the auto-hide feature turns on automatically.

## SMART Response tab

The SMART Response tab is part of SMART Response software and is available only if you have SMART Response software installed.

## Page area

The page area displays the contents of a selected page in a file. This is the area of the page where you create and work with objects (see *Creating basic objects* on page 33).



## Viewing tool change notifications

If your SMART product has Touch Recognition enabled, SMART Notebook software displays tool change notifications when you select a new hardware tool or change a tool's settings. Pens, the eraser and the mouse are all hardware tools. You can also view tool change notifications when you touch the display with your finger.

### NOTE

Only some SMART hardware products support Touch Recognition. For more information, refer to your SMART hardware product's user's guide.

### To view tool change notifications

Using a hardware tool or your finger, press the toolbar to select tool settings.

A status bar appears under the toolbar and shows the active tool and settings. The status bar updates each time you select another tool or setting.

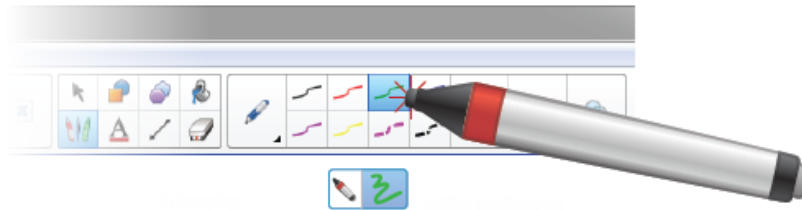

### NOTE

The status bar also appears when you assign ink settings to the hardware pen using the *Properties* tab (see *Changing objects' properties* on page 62).

## Using gestures

You can interact with objects in SMART Notebook software using the following gestures (if supported by your interactive product):

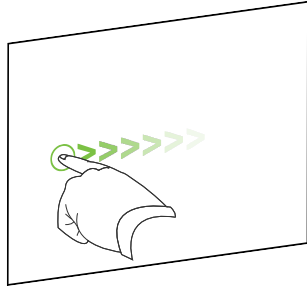

Swipe (left to right)

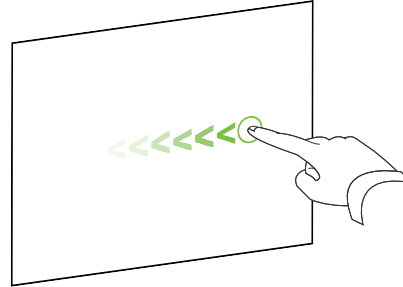

Swipe (right to left)

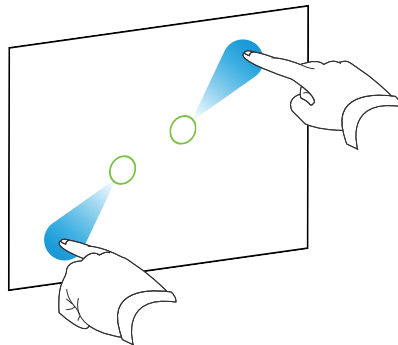

Pinch to zoom in / scale (enlarge)

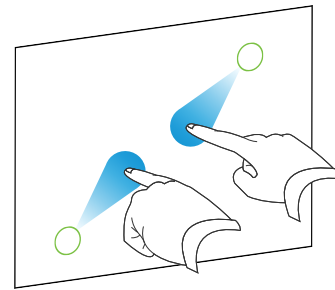

Pinch to zoom out / scale (reduce)

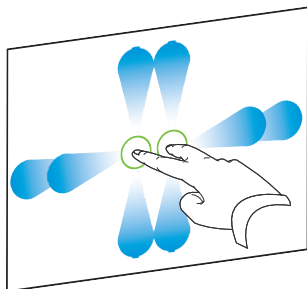

Pan

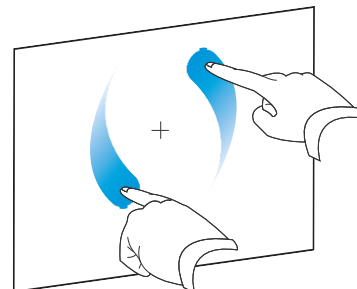

Rotate

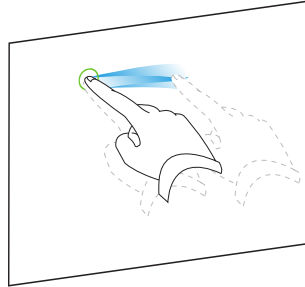

Shake

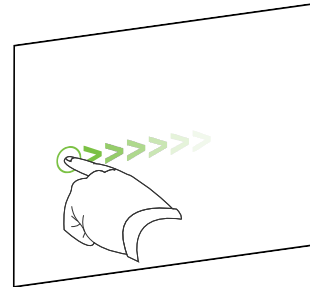

Flick

## Undoing and redoing actions

When you make changes to a file, you can reverse the effects of your previous actions and commands.

### NOTE

If two people are using your interactive product, pressing **Undo** and **Redo** affects the actions of both users.

### To reverse the effect of the last action

Press **Undo** .

### NOTE

You can undo an unlimited number of actions.

### To reinstate the last action reversed with the Undo command

Press **Redo** .



## Chapter 2

# Creating and working with files

Creating files .....	15
Opening files .....	15
Saving files .....	16
Exporting files .....	17
Printing files .....	19
Saving files automatically .....	20
Attaching files to e-mail messages .....	24

---

In SMART Notebook software, you can create or open SMART Notebook software (.notebook) files. After creating or opening a .notebook file, you can save it, print it and complete other common tasks.

## Creating files

When you start SMART Notebook software for the first time, a tutorial file opens automatically. When you start the software subsequent times, a new .notebook file opens automatically. However, you can create a new file at any time.

### To create a file

Select **File > New**.

If you're working on a file with unsaved changes, a dialog box appears and prompts you to save the current file. Press **Yes** to save your changes, and then follow the on-screen instructions.

## Opening files

With SMART Notebook 11 software, you can open the following:

- .notebook files (the default file format for SMART Notebook 9.5, 9.7, 10 and 11 software)
- .xbk files (the default file format for SMART Notebook 8.x, 9.0 and 9.1 software)

After you open a file, you can save the file as a .notebook file.

The method by which you open a file is the same for all versions of SMART Notebook software.

### To open a file

1. Press **Open File** .

The *Open* dialog box appears.

2. Browse to and select the file.
3. Press **Open**.



#### TIP

You can open a recently opened file by selecting the **File** menu, and then selecting the file name.

## Saving files

By default, SMART Notebook software saves your files in .notebook format. Anyone with SMART Notebook 9.5 or later software for Windows operating systems, Mac OS X operating system software or Linux operating systems installed on his or her computer can open a .notebook file.

### To save a new file

1. Press **Save** .

The *Save As* dialog box appears.

2. Browse to where you want to save the new file.
3. Type a name for the file in the *File name* box.
4. Press **Save**.

### To save an existing file

Press **Save** .

### To save an existing file with a new name or location

1. Select **File > Save As**.

The *Save As* dialog box appears.

2. Browse to where you want to save the new file.

3. Type a name for the file in the *File name* box.
4. Press **Save**.

## Exporting files

You can export your .notebook files to the following formats:

- Web pages
- Picture formats
  - BMP
  - GIF
  - JPEG
  - PNG
- PowerPoint®
- PDF
- Interactive Whiteboard Common File Format (CFF)



### NOTES

- SMART Notebook software doesn't include attachments when you export files as picture files. To include attachments, you must export your file as either web pages or PDF (Adobe® Reader® 6.0 or later).
- SMART Notebook software doesn't export files that you attach to your .notebook file as shortcuts. If you want to include an attachment, attach a copy of the file (see *Attaching files and web pages* on page 99).
- SMART Notebook software doesn't export some gradient, pattern and image effects. These effects might appear as a solid fill or appear incorrectly in the exported file.

You can also set SMART Notebook software to save a .notebook file in one of the above formats automatically when you display a different page or after a specified period of time (see *Saving files automatically* on page 20).

### To export a file as web pages

1. Select **File > Export As > Web Page**.  
The *Save As* dialog box appears.
2. Browse to where you want to export the file.

3. Type a name for the file in the *File name* box.
4. Press **Save**.

#### To export a file as picture files

1. Select **File > Export As > Image Files**.  
The *Save As* dialog box appears.
2. Select a folder where you want to export the files.
3. Select a picture format in the *Image Type* drop-down list.
4. Select a picture size in the *Size* drop-down list.
5. Press **OK**.

#### To export a file as a PowerPoint file

1. Select **File > Export As > PowerPoint**.  
The *Save As* dialog box appears.
2. Browse to where you want to export the file.
3. Type a name for the file in the *File name* box.
4. Select **PowerPoint 2007 Files (\*.pptx)** or **PowerPoint Files (\*.ppt)** in the *Save at type* drop-down list.
5. Press **Save**.



#### NOTE

You can also import PowerPoint files (see *Importing PowerPoint files* on page 94).

#### To export a file as a PDF file

1. Select **File > Export As > PDF**.  
The *Export PDF* dialog box appears.
2. Press **Thumbnails, Handouts** or **Full Page**.
3. Optionally, type header text in the *Header* box, footer text in the *Footer* box and the current date in the *Date* box.
4. Optionally, select the **Show page numbers** check box to show a page number on each page.



5. If you pressed **Thumbnails** or **Handouts** in step 2, select a thumbnail size in the *Thumbnail size* drop-down list and, optionally, select the **Page borders** check box to show a border around each thumbnail and the **Thumbnail titles** check box to show titles under each thumbnail.
6. Select **All** to include all pages.

OR

Select **Pages** to include select pages, and then type the page numbers in the box. Separate individual page numbers with commas and separate page ranges with a hyphen (for example, **1,2,4-7**).

7. Press **Save**.  
The *Save as PDF File* dialog box appears.
8. Browse to where you want to export the file.
9. Type a name for the file in the *File name* box.
10. Press **Save**.

#### To export a file as a CFF file

1. Select **File > Export As > CFF**.  
The *Save As* dialog box appears.
2. Browse to where you want to export the file.
3. Type a name for the file in the *File name* box.
4. Press **Save**.



#### NOTE

You can also import CFF files (see *Importing files from other interactive whiteboard programs* on page 95).

## Printing files

You can print all pages or select pages in a .notebook file. You can print the pages as thumbnails, handouts or full pages.

### To print a file

1. Select **File > Print**.

The *Print* dialog box appears.

2. Press **Thumbnails, Handouts** or **Full Page**.
3. Optionally, type header text in the *Header* box, footer text in the *Footer* box and the current date in the *Date* box.
4. Optionally, select the **Show page numbers** check box to show a page number on each page.
5. If you pressed **Thumbnails** or **Handouts** in step 2, select a thumbnail size in the *Thumbnail size* drop-down list and, optionally, select the **Page borders** check box to show a border around each thumbnail and the **Thumbnail titles** check box to show titles under each thumbnail.
6. Select **All** to include all pages.

OR

Select **Pages** to include select pages, and then type the page numbers in the box. Separate individual page numbers with commas and separate page ranges with a hyphen (for example, **1,2,4-7**).

7. Press the **Printer Setup** tab.
8. Specify other print settings, including the printer name and the number of copies.
9. Press **Print**.

## Saving files automatically

You can manually save your .notebook files at any time (see *Saving files* on page 16) and export them to a variety of formats (see *Exporting files* on page 17). You can also set SMART Notebook software to save your file automatically when you display a different page or after a specified period of time.

### NOTES

- SMART Notebook software doesn't include attachments when you export files as picture files. To include attachments, you must export your file as either web pages or PDF (Adobe Reader 6.0 or later).
- SMART Notebook software doesn't export files that you attach to your .notebook file as shortcuts. If you want to include an attachment, attach a copy of the file (see *Attaching files and web pages* on page 99).

- SMART Notebook software doesn't export some gradient, pattern and image effects. These effects might appear as a solid fill or appear incorrectly in the exported file.

### To save a file automatically

1. Select **File > Timed Saves**.

The *Timed Save Wizard* appears.

2. Select **Every time I move to a different page** to save your file automatically every time you select a different page.

OR

Select **1 minute**, **5 minutes**, **15 minutes** or **30 minutes** to save your file automatically after a specified period of time.

3. Press **Next**.
4. Select **Notebook Document**.
5. Press **Next**.

The *Save As* dialog box appears.

6. Browse to where you want to save the new file.
7. Type a name for the file in the *File name* box. SMART Notebook software automatically saves the file with the .notebook file extension.
8. Press **Save**.

### To save a file automatically as web pages

1. Select **File > Timed Saves**.

The *Timed Save Wizard* appears.

2. Select **Every time I move to a different page** to export your file automatically when you display a different page.

OR

Select **1 minute**, **5 minutes**, **15 minutes** or **30 minutes** to export your file automatically after a specified period of time.

3. Press **Next**.
4. Select **Web Page (HTML)**.

5. Press **Next**.

The *Save As* dialog box appears.

6. Browse to where you want to export the file.
7. Type a name for the file in the *File name* box.
8. Press **Save**.

### To save a file automatically as PDF files

1. Select **File > Timed Saves**.

The *Timed Save Wizard* appears.

2. Select **Every time I move to a different page** to export your file automatically when you display a different page.

OR

Select **1 minute**, **5 minutes**, **15 minutes** or **30 minutes** to export your file automatically after a specified period of time.

3. Press **Next**.

4. Select **PDF**.

OR

Select **Time Stamped PDFs**, if you want the exported files' names to include the time of the export.

5. Press **Next**.

The *Save As* dialog box appears.

6. Browse to where you want to export the file.
7. Type a name for the file in the *File name* box.
8. Press **Save**.

### To save a file automatically as picture files

1. Select **File > Timed Saves**.

The *Timed Save Wizard* appears.

2. Select **Every time I move to a different page** to export your file automatically when you display a different page.

OR

Select **1 minute**, **5 minutes**, **15 minutes** or **30 minutes** to export your file automatically after a specified period of time.

3. Press **Next**.
4. Select **Image Files**.
5. Press **Next**.
6. Press **Browse**, browse to where you want to export the files, and then press **Open**.
7. Select the picture format in the *Image Type* drop-down list.
8. Select the picture size in the *Size* drop-down list.
9. Press **OK**.

#### To save a file automatically as a PowerPoint file

1. Select **File > Timed Saves**.

The *Timed Save Wizard* appears.

2. Select **Every time I move to a different page** to export your file automatically when you display a different page.

OR

Select **1 minute**, **5 minutes**, **15 minutes** or **30 minutes** to export your file automatically after a specified period of time.

3. Press **Next**.
  4. Select **PowerPoint**.
  5. Press **Next**.
- The *Save As* dialog box appears.
6. Browse to where you want to export the file.
  7. Type a name for the file in the *File name* box.
  8. Press **Save**.

### ■ To cancel automatic file saving

1. Select **File > Timed Saves**.

The *Timed Save Wizard* appears.

2. Select **Do not save the document automatically**.
3. Press **Next**.

## Attaching files to e-mail messages

You can send your file to others by attaching the file, or a PDF version of the file, to an e-mail message.

### ■ To attach a file to an e-mail message

Select **File > Send To > Mail Recipient**.

Your default e-mail program starts, creates a new message and attaches the current file to the message.

If you haven't saved the file, SMART Notebook software saves it as a temporary file called **untitled.notebook** and your e-mail program attaches this temporary file to the e-mail message.

### ■ To attach a file to an e-mail message as a PDF

Select **File > Send To > Mail Recipient (as PDF)**.

Your default e-mail program starts, creates a new message and attaches a PDF of the current file to the message.

If you haven't saved the file, SMART Notebook software saves the PDF file as a temporary file called **untitled.pdf** and your e-mail program attaches the temporary file to the e-mail message.

## Chapter 3

# Creating and working with pages

Displaying pages in a file .....	25
Creating pages .....	26
Cloning pages .....	27
Extending pages .....	27
Renaming pages .....	28
Cutting or copying and pasting pages .....	28
Rearranging pages .....	29
Grouping pages .....	30
Deleting pages .....	31

---

A .notebook file is composed of a series of pages, each with its own objects and properties.

A thumbnail of each page appears in the Page Sorter. Using either the Page Sorter or menu commands, you can display an existing page, create a blank page, create a clone of an existing page or delete an existing page.

## Displaying pages in a file

You can display any page in the file using the Page Sorter. You can display the next or previous page in the file using buttons or gestures.

### ■ To display a page

1. If the Page Sorter isn't visible, press **Page Sorter** .
2. Press the thumbnail of the page you want to display.

### ■ To display the next page in a file

Press **Next Page** .

OR

Swipe your finger across the page from right to left.

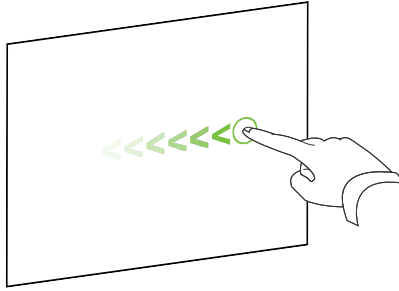

A message appears, displaying the current page's number.

2

**To display the previous page in a file**

Press **Previous Page** .

OR

Swipe your finger across the page from left to right.

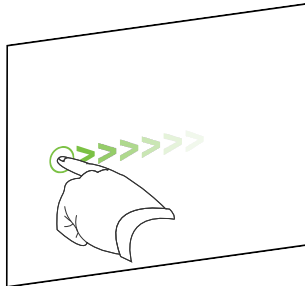

A message appears, displaying the current page's number.

2

## Creating pages

You can add a blank page to the open file using the *Add Page* button or the Page Sorter.



### To insert a page using the Add Page button

Press **Add Page** .

The new page appears after the current page.

### To insert a page using the Page Sorter

1. If the Page Sorter isn't visible, press **Page Sorter** .
2. Select the thumbnail of the page you want the new page to appear after.
3. Press the thumbnail's menu arrow, and then select **Insert Blank Page**.

The new page appears after the selected page.

## Cloning pages

As an alternative to creating a blank page, you can create a duplicate (or “clone”) of an existing page.

### NOTE

You can clone a page only if it contains content.

### To clone a page

1. If the Page Sorter isn't visible, press **Page Sorter** .
2. Select the thumbnail of the page you want to clone.
3. Press the thumbnail's menu arrow, and then select **Clone Page**.

The cloned page appears immediately after the current page.

### NOTE

You can repeat this process as many times as you want.

## Extending pages

If you need more room at the bottom of a page, you can extend the page vertically without affecting the page's width. You can turn this feature off to prevent your pages from becoming longer.

### To extend a page

1. If you're displaying the page in Entire Page view, select a different zoom level.
2. Press the **Extend Page** link at the bottom of the page.

### To turn Extend Page on or off

1. Select **View > Extend Page**
2. Select **Off** to turn the Extend Page feature off.

OR

Select **On** to turn the Extend Page feature on.

## Renaming pages

When you create a page, SMART Notebook software automatically names the page with the date and time of its creation. You can change this name.

### To rename a page

1. If the Page Sorter isn't visible, press **Page Sorter** .
2. Double-click the page's name.
3. Type a new name for the page.
4. Press elsewhere.

## Cutting or copying and pasting pages

You can cut or copy and paste a page from the current file using the Page Sorter.

### To cut or copy and paste a page using the Page Sorter

1. If the Page Sorter isn't visible, press **Page Sorter** .
2. Select the thumbnail of the page you want to cut.
3. Press the thumbnail's menu arrow, and then select **Cut Page** or **Copy Page**.
4. Select the thumbnail of the page you want to follow the pasted page.
5. Press the thumbnail's menu arrow, and then select **Paste Page**.

The new thumbnail appears preceding the thumbnail you selected in the previous step.



**TIP**

You can also copy and paste pages from other SMART Notebook software files.

## Rearranging pages

If you want, you can rearrange the order of the pages in a file.

### To rearrange pages

1. If the Page Sorter isn't visible, press **Page Sorter** .
2. Press the thumbnail of the page you want to move in the file.  
A blue border appears around the thumbnail.
3. Drag the thumbnail to its new position in the Page Sorter.  
A blue line indicates the page's new position.
4. Release the thumbnail.

## Grouping pages

You can group pages in a file. This enables you to find a particular group quickly in the Page Sorter, and then display its pages. This is useful when there are a lot of pages in a file.

### To create or edit a group

1. If the Page Sorter isn't visible, press **Page Sorter** .
2. Press the first group's menu arrow, and then select **Edit Page Groups**.

All the groups and pages for the current file are displayed. Groups appear as blue bars and pages appear as thumbnails:

- If you created and edited the groups in this file, the pages appear under the blue bars you created and renamed.
- If you haven't edited the groups, a default group titled *Group 1* appears and includes all of the pages and their thumbnails below its blue bar.



#### NOTE

Thumbnails below each blue bar include the same menu arrow options as thumbnails in the Page Sorter. This enables you to press a thumbnail in a group, select its menu arrow, and then delete the page, clear the page, insert a new page, clone the page, rename the page, add a Screen Shade to the page or add the page to the Gallery.

3. Press the **Add New Group** button in the upper-right corner.  
A new group, with a new, blank page, appears.
4. Type a new name for the group.

5. Do the following:

- To move a page into a group, press the page's thumbnail, and then drag it below the group's blue bar and to the right of the thumbnail you want it to follow.
- To rearrange the order of pages in a group, press a page's thumbnail, and then drag it to the right of the thumbnail you want it to follow.
- To rearrange the order of groups, press a group's blue bar, and then drag it below the blue bar of the group you want it to follow.



#### NOTES

- You can also change the order of the groups by pressing a blue bar's menu arrow, and then selecting **Move Up** or **Move Down**.
  - SMART Notebook software numbers pages sequentially across a file. If you change the order of groups, SMART Notebook software renumbers the pages in the groups accordingly.
- To delete a group and keep its pages, move all of its pages to different groups. When a group contains no pages, SMART Notebook software automatically deletes it.
  - To delete a group and all pages in the group, press the blue bar's menu arrow, and then select **Delete Group**.

6. Press .

### To access a group in the Page Sorter

1. If the Page Sorter isn't visible, press **Page Sorter** .
2. Press the first group's menu arrow, and then select the name of the group you want to access.

The Page Sorter displays the thumbnail for the first page in the group you want to access.

## Deleting pages

You can delete a page from the current file using the *Delete Page* button or the Page Sorter.



#### TIP

As an alternative to deleting a page, you can clear all of its objects (see *Clearing pages* on page 175).

■ **To delete a page using the Delete Page button**

1. If you haven't done so already, display the page you want to delete.
2. Select **Delete Page** .

■ **To delete a page using the Page Sorter**

1. If the Page Sorter isn't visible, press **Page Sorter** .
2. Select the thumbnail of the page you want to delete.
3. Press the thumbnail's menu arrow, and then select **Delete Page**.

## Chapter 4

# Creating basic objects

Writing, drawing and erasing digital ink .....	34
Writing or drawing digital ink .....	34
Erasing digital ink .....	37
Creating shapes and lines .....	37
Creating shapes with the Shapes tool .....	37
Creating shapes with the Regular Polygons tool .....	38
Creating shapes with the Shape Recognition Pen tool .....	39
Creating straight lines and arcs .....	40
Creating text .....	41
Typing text .....	42
Converting handwriting to typed text .....	42
Formatting text .....	43
Resizing text objects .....	45
Inserting mathematical symbols .....	46
Checking the spelling of text objects .....	46
Cutting and pasting text .....	47
Creating tables .....	48
Creating tables .....	48
Pasting tables from other programs .....	50
Adding objects to tables .....	50
Selecting tables, columns, rows or cells .....	51
Moving tables .....	52
Changing a table's properties .....	52
Resizing tables, columns or rows .....	54
Adding or removing columns, rows or cells .....	55
Splitting or merging table cells .....	56
Deleting tables and the contents of tables .....	57

---

Objects are the building blocks of content in your .notebook files. An object is simply an item on a page that you create or import and then work with. Basic types of objects include the following:

- Digital ink (freehand writing and drawing)
- Shapes

- Straight lines
- Arcs
- Text
- Tables

## Writing, drawing and erasing digital ink







Digital ink is freehand text or objects that you create using your interactive display's pen or pens, or the SMART Notebook software Pens tool. Writing or drawing digital ink enables you to quickly add content to your SMART Notebook software files, either when creating the files or when presenting the files to students.

After you create digital ink, you can erase it.









### Writing or drawing digital ink

The easiest way to write or draw digital ink is to use your interactive display's pen or pens.

You can also create freehand objects using the Pens tool. The Pens tool enables you to write or draw digital ink using the following pen types:

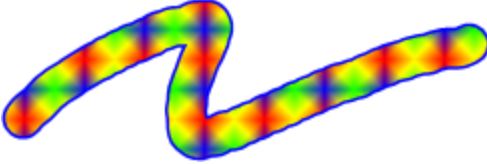
Pen type	Purpose and example	Notes
 Standard	Write or draw digital ink in a variety of colors and line styles. 	Using the Standard pen type, you can write or draw digital ink that fades after a few seconds (see <i>Using the Standard pen type to create fading objects</i> on page 151).
 Calligraphic	Write or draw digital ink, like you do with the Standard pen type, but with lines of varying thickness. 	The Calligraphic pen type is useful for teaching students handwriting.
 Crayon	Write or draw crayon-like digital ink. 	The Crayon pen type is intended for artistic work, such as painting and coloring pictures, rather than writing.



Pen type	Purpose and example	Notes
 Highlighter	Highlight text and other objects. 	
 Text	Write notes that automatically convert to editable text. 	You can edit your text as you work without touching a keyboard (see <i>Using the Text Pen</i> on page 147).
 Creative	Add colorful elements to your presentations. 	You can create custom Creative pen styles (see <i>Creating custom Creative pen styles</i> on page 108).
 Paint Brush	Write or draw paint-like digital ink. 	The Paint Brush pen type is intended for artistic work, such as painting and coloring pictures, rather than writing.
 Magic	Write or draw digital ink that fades after a few seconds.	You can also use the Magic Pen to open a magnification window or a spotlight window (see <i>Using the Magic Pen</i> on page 143).
 Shape Recognition	Draw a variety of shapes with digital ink.	You can draw circles, ovals, squares, rectangles, triangles and arcs (see <i>Creating shapes with the Shape Recognition Pen tool</i> on page 39).

## To write or draw digital ink

1. Press **Pens** .

The Pens tool buttons appear.

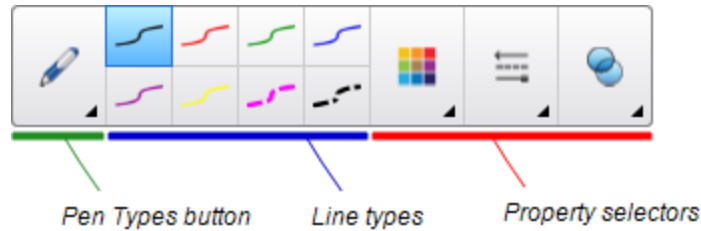

2. Press **Pen Types**, and then select a pen type.
3. Select a line type.
4. Optionally, customize the line type using the property selectors.



### NOTE

You can also customize the line type using the Properties tab (see *Changing objects' properties* on page 62).

5. Write or draw digital ink on the page.



### TIPS

- Don't rest your elbow or the palm of your hand on your interactive product's surface while you write or draw.
- If you write or draw multiple lines, SMART Notebook software automatically combines the lines into a single object. For example, if you write the letters of a word, SMART Notebook software combines the individual letters, enabling you to interact with the whole word. If you want to write words on the same line but don't want them combined, leave a large gap between them, use different pens, or briefly put the pen in the pen tray before writing another word (interactive whiteboards only).
- If you want to write diagonally, write in a straight line, and then rotate it (see *Rotating objects* on page 75).
- If you want to write in small letters, write large letters, and then reduce their size (see *Resizing objects* on page 72).
- You can fill areas that you've enclosed with digital ink (see *Filling digital ink drawings* on page 64).

## Erasing digital ink

You can erase digital ink from your interactive display using the eraser or the erasing gesture. If you're erasing digital ink from a .notebook file page, you can also erase objects using the Eraser tool.

### NOTE

Although you can erase digital ink, you're unable to erase other types of objects, including shapes, lines, text and pictures. To remove these types of objects, you must delete them (see *Deleting objects* on page 79).

### To erase digital ink

1. Press **Eraser**  , and then select an eraser type.
2. Erase the digital ink.

## Creating shapes and lines

In addition to creating freehand shapes and lines by drawing digital ink, you can create shapes and lines using the tools in SMART Notebook software.

### NOTE

To remove a shape or line from a page, you must delete it (see *Deleting objects* on page 79). The Eraser tool doesn't remove shapes.

## Creating shapes with the Shapes tool

You can use the Shapes tool to create a variety of shapes, including perfect circles, perfect squares, perfect triangles, other geometric shapes, hearts, check marks and Xs .

You can add a shape to your page, and then edit its properties. Alternatively, you can customize a shape's outline color, fill color and line thickness, and then add it to your page.

## To create a shape

1. Press **Shapes** .

The Shapes tool buttons appear.



2. Select a shape on the toolbar.  
OR  
Press ▼ and then select a shape.
3. Optionally, customize the shape using the property selectors.





### NOTE

You can also customize the shape using the Properties tab (see *Changing objects' properties* on page 62).

4. Create a shape by pressing where you want to place the shape and dragging until the shape is the size you want.



### TIPS

- You can create perfect circles, squares, triangles and other shapes by holding down SHIFT as you draw the shape.
- You can select a shape while the **Shapes** tool  is active without having to switch to the **Select** tool . Press the shape once, and a selection rectangle appears around the shape.

## Creating shapes with the Regular Polygons tool

In addition to creating shapes using the Shapes tool, you can create regular polygons with 3 to 15 sides using the Regular Polygons tool.

## To create a shape with the Regular Polygons tool

1. Press **Regular Polygons** .

The Regular Polygons tool buttons appear.



2. Select a shape on the toolbar.  
OR  
Press ▼ and then select a shape.



### NOTE

The number in the shape indicates its number of sides.

3. Optionally, customize the shape using the property selectors.



### NOTE

You can also customize the shape using the Properties tab (see *Changing objects' properties* on page 62).

4. Create a shape by pressing where you want to place the shape and dragging until the shape is the size you want.

## Creating shapes with the Shape Recognition Pen tool

You can use the Shape Recognition Pen tool to draw circles, ovals, squares, rectangles, triangles and arcs.



### NOTE

You can also create shapes using the Shapes tool (see *Creating shapes with the Shapes tool* on page 37) or the Regular Polygons tool (see *Creating shapes with the Regular Polygons tool* on the previous page).

### To draw a shape

1. Press **Pens** .

The Pens tool buttons appear.

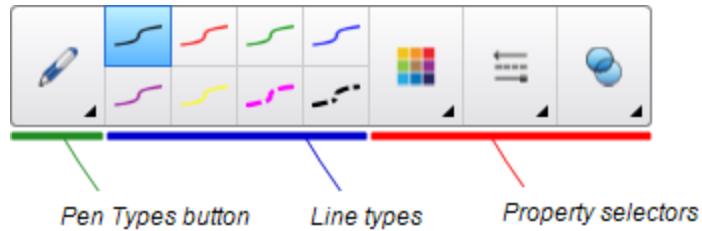

2. Press **Pen Types**, and then select **Shape Recognition Pen**.
3. Draw a shape on the page.

If SMART Notebook software recognizes your drawing as a circle, oval, square, rectangle, triangle or arc, it adds this shape to the page.



### Creating straight lines and arcs

You can use the Lines tool to draw straight lines and arcs.

You can add a line to your page, and then edit its properties. Alternatively, you can customize the line, and then add it to your page.

**To create a straight line or arc**

1. Press **Lines** .

The Lines tool buttons appear.

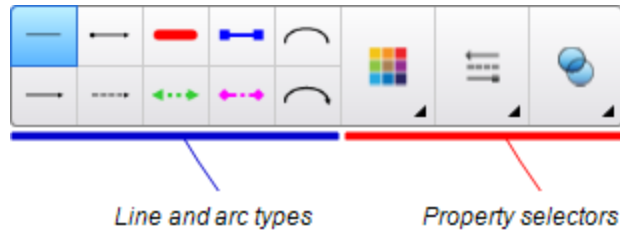

2. Select a line or arc type.
3. Optionally, customize the line or arc type using the property selectors.



**NOTE**

You can also customize the line or arc type using the Properties tab (see *Changing objects' properties* on page 62).

4. Create a line by pressing where you want the line to start and dragging to where you want the line to end.

## Creating text

You can create text in SMART Notebook software by doing any of the following:



- Typing the text using a keyboard connected to your computer
- Typing the text using SMART Keyboard
- Writing the text (see *Writing, drawing and erasing digital ink* on page 34) and then converting it to typed text using the software's handwriting recognition feature

After creating text, you can edit it, check its spelling and change its properties, including font style, size and color.

## Typing text

You can type new text or edit existing text.

### To type new text

1. If a keyboard isn't accessible, press the **SMART Board** icon  in the notification area, and then select **Keyboard**.
2. Press **Text** , and then select an available font style.
3. Optionally, customize the font style (see *Formatting text* on the next page).
4. Press where you want the text to start.
5. Type your text.
6. When you're done, press outside the text object.

### To edit existing text

1. Double-click the text object.
2. Edit the text.
3. When you're done, press outside the text object.

## Converting handwriting to typed text

You can write on your interactive product's screen using the Standard or Calligraphic pen types and convert your writing to typed text. SMART Notebook software can convert handwriting in multiple languages.

### To convert handwriting to typed text

1. Press **Pens** .

The Pens tool buttons appear.

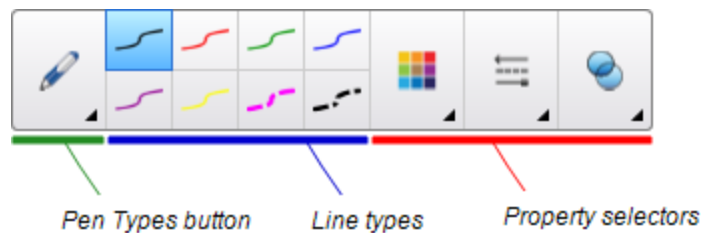

2. Press **Pen Types**, and then select **Pen** or **Calligraphic Pen**.



3. Write your text.



**TIP**

Write tidy, printed characters on a horizontal line. Although SMART Notebook software can convert slanted or cursive writing, it doesn't always do so consistently.

4. Select the text object.

The SMART Notebook software handwriting recognition feature compares your written word with its dictionary and identifies words that most resemble what you've written.

5. Press the text object's menu arrow.

A menu appears and displays the list of matching words, each preceded by *Recognize*.



**NOTES**

- If you want SMART Notebook software to identify words in a different language, select **Recognize Languages**, and then select another language in the list. SMART Notebook software updates the list of matching words to include words in the selected language.
- If you change the handwriting recognition language, you don't change the default language of the SMART Notebook software user interface or your operating system.

6. Select a word in the list of matching words.

The selected word appears on the page.

## Formatting text

If you want to format all text in a text object, select the text object.

OR

If you want to format specific text in a text object, double-click the text object, and then select the text.



You can format text using the buttons in the toolbar or the options in the Properties tab or the Format menu.



**NOTE**

If the Properties tab isn't visible, press **Properties** , and then press **Text Style**.

The following table presents the formatting changes that you can make using the above tools:



Change	Toolbar	Properties tab	Format menu
<b>Character, paragraph or object level</b>			
Change the font face	✓	✓	
Change the font size	✓	✓	
 <b>TIP</b> To select a font size that doesn't appear in the drop-down list (including font sizes with decimal values such as 20.5), type the font size in the <i>Font Size</i> box on the toolbar.			
Change the color	✓	✓	
Bold, italicize or underline text	✓	✓	✓
Strike out text	✓ <sup>1</sup>	✓	✓
Superscript or subscript text	✓ <sup>2</sup>	✓	✓
<b>Paragraph or object level</b>			
Change justification (left, right or center)	✓	✓	✓
Change indentation	✓ <sup>3</sup>	✓	✓
Create a bulleted or numbered list	✓ <sup>4</sup>	✓	✓
Insert a drop cap		✓	✓
 <b>TIP</b> To insert a drop cap at the beginning of a paragraph, press <b>Drop Cap</b>  in the <i>Properties</i> tab under <i>Text Style</i> .  OR Select <b>Format &gt; Paragraph &gt; Drop Cap</b> .			

<sup>1</sup>Under *More Text Options* 

<sup>2</sup>Under *More Text Options* 

<sup>3</sup>Under *More Text Options* 

<sup>4</sup>Under *More Text Options* 

Change	Toolbar	Properties tab	Format menu
Change line spacing		✓	✓
<div style="background-color: #f0f0f0; padding: 5px;">  <b>TIP</b>            To add spacing between paragraphs, select the <b>Add space after paragraphs</b> check box in the Properties tab or select <b>Format &gt; Paragraph &gt; Line Spacing &gt; Add space after paragraphs</b>.         </div>			
Change language direction (left-to-right or right-to-left)			✓
<div style="background-color: #f0f0f0; padding: 5px;">  <b>NOTE</b>            Select <b>Format &gt; Paragraph &gt; Direction &gt; Left to Right</b> for languages that read left to right (for example, English and French).             OR             Select <b>Format &gt; Paragraph &gt; Direction &gt; Right to Left</b> for languages that read right to left (for example, Arabic and Hebrew).         </div>			
<b>Object level</b>			
Change text direction (horizontal or vertical)	✓ <sup>5</sup>	✓	✓
Change transparency	✓	✓	

## Resizing text objects

When you resize a text object following the procedure in *Resizing objects* on page 72, the text in the object changes size.

If you want to resize the text object without changing the size of the text in the object, complete the following procedure.

### To resize a text object

1. Double-click the text object.
2. Press one of the two white circles on either side of text object, and then drag the circle to increase or reduce the text object's size.

<sup>5</sup>Under *More Text Options* 



## Inserting mathematical symbols

You can insert a variety of mathematical and scientific symbols into a page.

### NOTE

The mathematical symbols are characters only. They don't perform mathematical operations.

#### To insert a mathematical symbol

1. Type text on a page.
2. Press **More Text Options**  and then select **Insert Symbol** .

The *Insert Symbols* dialog box appears.

3. Press a category.  
A list of symbols appears.
4. Press the symbol you want to add to the text.
5. Press **Insert**.



The symbol appears in the text object.

## Checking the spelling of text objects

As you type text, SMART Notebook software checks the spelling. If you spell a word incorrectly, SMART Notebook software underlines the word red. You can then right-click the word and select the correct spelling from a list of options.

If you prefer, you can disable this feature and check the spelling using the *Spelling Check* dialog box.

#### To disable automatic spell checking

1. Press **Text** .
2. Press **More Text Options** , and then select **Check Spelling** .

#### To manually check spelling of a text object

1. Select the text object.
2. Press the object's menu arrow, and then select **Check Spelling**.

If SMART Notebook software finds a misspelled word, the *Spelling Check* dialog box appears. This dialog box displays the misspelled word and suggests alternatives.

3. For each misspelled word, do one of the following:
  - To keep the word's current spelling for this instance, press **Ignore Once**.
  - To keep the word's current spelling for all instances in the file, press **Ignore All**.
  - To keep the word's current spelling for all instances in the file and add the spelling to the dictionary, press **Add to Dictionary**.
  - To change the word's spelling for this instance, select the correct word in the *Suggestions* list, and then press **Change**.
  - To change the word's spelling for all instances in the file, select the correct word in the *Suggestions* list, and then press **Change All**.



**NOTE**

If you pressed a button by mistake, press **Undo** to undo the resulting change.

After you complete this step for each misspelled word, a dialog box appears asking whether you want to check the spelling in the rest of the file.

4. Press **Yes** to check the remainder of the file.

OR

Press **No** to close the *Spelling Check* dialog box without checking the rest of the file.

## Cutting and pasting text

You can cut, copy and paste text objects like any other objects (see *Cutting, copying and pasting objects* on page 69). You can also cut and paste text in a text object.

### **To cut and paste text to another location on the same page**

1. Double-click the text object.
2. Select the text you want to cut.
3. Drag the selected text to another location on the same page.

### **To cut and paste text to another page**

1. If the Page Sorter tab isn't visible, press **Page Sorter** .
2. Double-click the text object.
3. Select the text you want to copy.
4. Drag the selected text to the other page's icon in the Page Sorter tab.

## Creating tables

You can create tables in SMART Notebook software or paste them from other programs. After you create a table, you can insert objects into the table's cells.

If you want to customize a table, you can select a table, column, row, cell or selection of cells, and then do any of the following:

- Move the table
- Change line type, fill and text properties
- Resize the table, a column or a row
- Insert or remove columns, rows or cells
- Split or merge cells
- Delete the table

## Creating tables

### To insert a table using the Table button

1. Press **Table** .

A grid appears.

2. Move the pointer over the grid to select the number of columns and rows that you want in the table.



#### NOTE

The cells of the grid correspond to the cells of your table.



#### TIP

The grid displays eight rows and eight columns by default. You can add rows by moving the pointer past the bottom row. Similarly, you can add columns by moving the pointer past the right row.

If you're using a mouse, click and hold the left mouse button while moving the pointer.

3. Press the screen or click your mouse.

The table appears on the page.

**To insert a table using the Insert Table dialog box**

1. Select **Insert > Table**.

The *Insert Table* dialog box appears.

2. Type the number of rows and columns in the boxes.
3. Optionally, select **Make cells square** to make the table cells square.
4. Optionally, select **Remember dimensions for new tables** to use the current table dimensions for all future tables that you create in SMART Notebook software.
5. Press **OK**.

The table appears on the page.

**To draw a table**

1. Press **Pens** .

The Pens tool buttons appear.

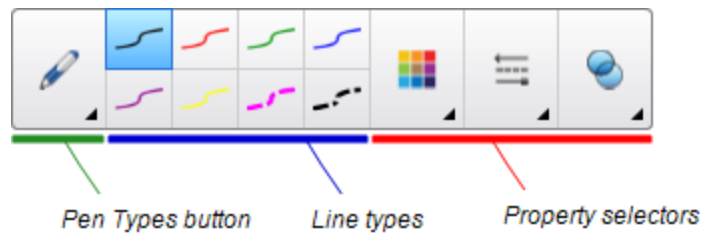

2. Press **Pen Types**, and then select **Pen** or **Calligraphic Pen**.
3. Select a line type.
4. Draw a table on the screen.



**TIP**

Make the lines of the table as straight as possible and connect the corners.

5. Press **Select** .
6. Select your drawing.
7. Press the menu arrow, and then select **Recognize Table**.

If SMART Notebook software recognizes your drawing as a table, it removes your drawing and adds a table to the page.

## Pasting tables from other programs

You can cut or copy a table from Word or PowerPoint, and then paste it into a .notebook file. The table's formatting and layout can vary when the table appears in the .notebook file.

If you want to cut or copy more than one table, you must cut or copy each table individually.

### NOTE

You can also cut or copy a table from a .notebook file, and then paste it into Word or PowerPoint. However, the table's formatting and layout can vary when the table appears in Word or PowerPoint.

If you're pasting a table into PowerPoint which has cells that contain non-text objects, the non-text objects appear outside of the table in PowerPoint.

## Adding objects to tables

After you insert a table on a page, you can insert objects into the table's cells.

### NOTE

You can add only one object to each cell. If you want to add multiple objects to a cell, do one of the following:

- Group the objects before adding them to the table (see *Grouping objects* on page 77).
- Select all of the objects at once, and then add them to the table as described in the following procedure. SMART Notebook software automatically groups the objects in the table cell.

### To add an object to a table

1. Select the object.
2. Drag the object to the table cell.

### NOTE

You're unable to move an object if it's locked in place (see *Locking objects* on page 114).

The object appears in the table cell.

### NOTE

If you add a text object to a table, the cell resizes to fit to the text object. If you add other object types to the table, the object resizes to fit the cell.



### ■ To remove an object from a table

1. Select the object.
2. Drag the object out of the table.

## Selecting tables, columns, rows or cells

You can select a table, column, row, cell or selection of cells. After you select a table or part of a table, you can do the following:

- Move the table
- Change the table's or cells' properties
- Resize the table, columns or rows
- Add or remove columns, rows or cells
- Split or merge cells
- Delete the table

### ■ To select a table

1. Press **Select**  .
2. Press outside, but near to, a corner of the table, and then drag to the opposite corner.



#### NOTE

Don't start dragging from inside the table. If you do, you select a table cell instead of the table.

### ■ To select a column

1. Press **Select**  .
2. Press inside the column's top cell, and then drag to the bottom cell.

### ■ To select a row

1. Press **Select**  .
2. Press inside the row's leftmost cell, and then drag to the rightmost cell.

### To select a cell

1. Press **Select** .
2. Press inside the cell.

### To select multiple cells

1. Press **Select** .
2. Press inside the top and leftmost cell, and then drag to the bottom and rightmost cell.



#### NOTE

If you select multiple cells and drag them to a different position on the page, you create a new table consisting of the selected cells and their contents.

## Moving tables

After you create a table, you can move it on the page.

### To move a table

Select the table, and then drag it to a different position on the page.

OR

Select all of the table's cells, and then drag the cells to a different position on the page.



## Changing a table's properties

You can use the Properties tab to change the table's properties, including its transparency, cell color and line color.

### To change a table's fill

1. Select a table, column, row, cell or selection of cells.
2. Press the table's, column's, row's or cell's menu arrow, and then select **Properties**.
3. Press **Fill Effects**.

4. Select a fill style:

Fill style	Procedure
None (transparent)	Select <b>No fill</b> .
Solid color	<ol style="list-style-type: none"><li>Select <b>Solid fill</b>.</li><li>Do one of the following:<ul style="list-style-type: none"><li>Select one of the 40 colors in the palette.</li><li>Press <b>More</b>, and then select a color in the dialog box.</li><li>Press the eyedropper , and then select a color on the screen.</li></ul></li></ol>
Gradient of two colors	<ol style="list-style-type: none"><li>Select <b>Gradient fill</b>.</li><li>For each color, do one of the following:<ul style="list-style-type: none"><li>Select one of the 40 colors in the palette.</li><li>Press <b>More</b>, and then select a color in the dialog box.</li><li>Press the eyedropper , and then select a color on the screen.</li></ul></li><li>Select an option in the <i>Style</i> drop-down list.</li></ol>
Pattern	<ol style="list-style-type: none"><li>Select <b>Pattern fill</b>.</li><li>Select a pattern.</li></ol>
Picture	<ol style="list-style-type: none"><li>Select <b>Image fill</b>.</li><li>Press <b>Browse</b>.</li><li>Browse to and select the picture you want to use as a background, and then press <b>Open</b>.</li></ol> <div data-bbox="722 1266 1461 1470" style="background-color: #f0f0f0; padding: 5px;"><p> <b>NOTE</b> If you insert a large picture, a dialog box may appear and prompt you to either reduce the picture's file size or retain the picture's file size. For more information, see <i>Setting image optimization preferences</i> on page 193.</p></div> <ol style="list-style-type: none"><li>Select <b>Keep image size</b> to keep the picture's size, regardless of whether the picture is larger or smaller than the object. OR Select <b>Scale image to fit</b> to resize the picture to fit the object.</li></ol>

5. Optionally, drag the **Object transparency** slider to the right to make the table transparent.

### To change a table's line style

1. Select a table.



#### NOTE

You can only change the line style of an entire table, not individual cells, columns or rows.

2. Press the table's, column's, row's or cell's menu arrow, and then select **Properties**.
3. Press **Line Style**.
4. Change the table's line style.

### To change a table's text style

1. Select a table, column, row, cell or selection of cells.
2. Press the table's, column's, row's or cell's menu arrow, and then select **Properties**.
3. Press **Text Style**.
4. Change the table's text style (see *Formatting text* on page 43).

## Resizing tables, columns or rows

If you want to customize a table, you can resize the table, a column or a row.

### To resize a table

1. Select the table.
2. Press the table's resize handle (the gray circle), and then drag it to increase or reduce the size of the table.

### To resize a column

1. Press **Select**  .
2. Press the vertical border to the right of the column.  
A resize pointer appears.
3. Drag the vertical border to resize the column.

### ■ To resize a row

1. Press **Select**  .
2. Press the horizontal border below the row.  
A resize pointer appears.
3. Drag the horizontal border to resize the row.

### ■ To resize all cells in a table

1. Select the table.
2. Press the table's menu arrow, and then select **Adjust size**.
3. Select one of the following options:
  - **Make same height** to make all cells in the table the same height.
  - **Make same width** to make all cells in the table the same width.
  - **Make same size** to make all cells in the table the same height and width.
  - **Make cells square** to make all cells in the table square.

## Adding or removing columns, rows or cells

If you want to customize a table, you can add columns or rows.

### ■ To add a column

1. Select a column.
2. Press the column's menu arrow, and then select **Insert Column**.  
A new column appears to the right of the current column.

### ■ To remove a column

1. Select the column.
2. Press the column's menu arrow, and then select **Delete Column**.

### ■ To add a row

1. Select a row.
2. Press the row's menu arrow, and then select **Insert Row**.  
A new row appears below the current row.

### To remove a row

1. Select the row.
2. Press the row's menu arrow, and then select **Delete Row**.

### To remove a cell

1. Select the cell.
2. Press the cell's menu arrow, and then select **Delete Cells**.



#### NOTE

- Removing a cell deletes the contents of the cell.
- You're unable to remove a cell if it provides the only connection between two halves of a table.

## Splitting or merging table cells

You can add tables to your page and insert objects into the table's cells. If you want to customize a table, you can split or merge cells.

### To split a cell

1. Select the cell.
2. Press the cell's menu arrow, and then select **Split**.
3. Select an option to split the cell into multiple rows and/or columns.



#### NOTE

If you split a cell that contains content, the content appears in the upper-left cell after the split.

### To merge cells

1. Select the cells.
2. Press the cells' menu arrow, and then select **Merge Cells**.



#### NOTE

If you merge cells that contain content, the merged cell contains the contents of the top-left cell. If the top-left cell is empty, the merged cell contains the contents of the next available non-empty cell, moving from left to right, top to bottom.

## Deleting tables and the contents of tables

You can delete the contents of a table or the table itself.

### NOTE

You can delete all objects on a page, including tables, by clearing the page (see *Clearing pages* on page 175).

#### To delete the contents of a table

1. Select the cells containing the content you want to delete.
2. Press **Delete** .

#### To delete a table

1. Select the table.
2. Press the table's menu arrow, and then select **Delete**.





## Chapter 5

# Working with objects

Selecting objects .....	60
Changing objects' properties .....	62
Changing the fill .....	62
Filling digital ink drawings .....	64
Changing other properties .....	65
Saving tool settings .....	65
Positioning objects .....	65
Moving objects .....	66
Moving objects to another page .....	67
Aligning objects .....	67
Rearranging stacked objects .....	69
Cutting, copying and pasting objects .....	69
Cropping images with a mask .....	70
Cloning objects .....	72
Resizing objects .....	72
Using the resize handle .....	73
Using the scale gesture .....	73
Rotating objects .....	75
Using the rotation handle .....	75
Using the rotate gesture .....	76
Flipping objects .....	77
Grouping objects .....	77
Grouping objects manually .....	77
Using the menu .....	77
Using the shake gesture .....	78
Grouping objects automatically .....	78
Deleting objects .....	79

---

After creating an object, you can select it and work with it as described in this chapter.

### NOTE

The tasks described in this chapter are for all objects, not just basic objects.

## Selecting objects

Before you can work with an object, you must select it. You can select an individual object, multiple objects or all objects on a page. When you select an object, a selection rectangle appears around it.

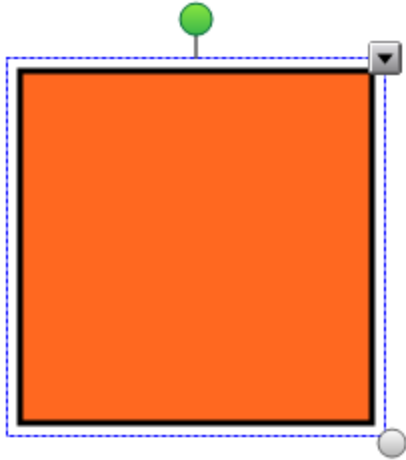

The gray circle in the object's lower-right corner is a resize handle (see *Resizing objects* on page 72).

The green circle above the object is a rotation handle (see *Rotating objects* on page 75).

The downward arrow in the object's upper-right corner is a menu arrow. Press the menu arrow to display a menu of commands.

### NOTE

Pressing an object's menu arrow gives you access to the same menu as right-clicking the object.

### To select an object

1. Press **Select** .
2. Press the object you want to select.

A selection rectangle appears around the object.

### NOTE

If you press an object and a lock symbol appears instead of the menu arrow, the object is locked. Depending on the type of lock, you might have to unlock the object before you can manipulate it (see *Locking objects* on page 114).

### To select multiple objects

1. Press **Select** .
2. Press the interactive screen and drag until a rectangle surrounds the objects you want to select.

OR

Hold down CTRL, and then press the objects you want to select.

A selection rectangle appears around the selected objects.



#### NOTE

If you draw a rectangle around multiple objects and some of the objects are locked (see *Locking objects* on page 114), you select only the unlocked objects.

### To select all objects on a page

Select **Edit > Select All**.

A selection rectangle appears around all objects on the page.



#### NOTE

If some of the objects are locked (see *Locking objects* on page 114), you select only the unlocked objects.

### To select all locked objects on the page

Select **Edit > Select All Locked Notes**.

A selection rectangle appears around all locked objects on the page.

## Changing objects' properties

You can change an object's properties. The properties you can change depend on the object you select. You can also select several objects and change their properties at the same time.



### Changing the fill

You can change an object's fill by selecting the object and then setting the fill in the Properties tab or by clicking **Fill** , setting the fill, and then selecting the object.

#### To change an object's fill by first selecting the object

1. Select the object.
2. If the Properties tab isn't visible, press **Properties** .
3. Press **Fill Effects**.

4. Select a fill style:

Fill style	Procedure
None (transparent)	Select <b>No fill</b> .
Solid color	<ol style="list-style-type: none"><li>Select <b>Solid fill</b>.</li><li>Do one of the following:<ul style="list-style-type: none"><li>Select one of the 40 colors in the palette.</li><li>Press <b>More</b>, and then select a color in the dialog box.</li><li>Press the eyedropper , and then select a color on the screen.</li></ul></li></ol>
Gradient of two colors	<ol style="list-style-type: none"><li>Select <b>Gradient fill</b>.</li><li>For each color, do one of the following:<ul style="list-style-type: none"><li>Select one of the 40 colors in the palette.</li><li>Press <b>More</b>, and then select a color in the dialog box.</li><li>Press the eyedropper , and then select a color on the screen.</li></ul></li><li>Select an option in the <i>Style</i> drop-down list.</li></ol>
Pattern	<ol style="list-style-type: none"><li>Select <b>Pattern fill</b>.</li><li>Select a pattern.</li></ol>
Picture	<ol style="list-style-type: none"><li>Select <b>Image fill</b>.</li><li>Press <b>Browse</b>.</li><li>Browse to and select the picture you want to use as a background, and then press <b>Open</b>.</li></ol> <div data-bbox="722 1266 1461 1470" style="background-color: #f0f0f0; padding: 5px;"><p> <b>NOTE</b> If you insert a large picture, a dialog box may appear and prompt you to either reduce the picture's file size or retain the picture's file size. For more information, see <i>Setting image optimization preferences</i> on page 193.</p></div> <ol style="list-style-type: none"><li>Select <b>Keep image size</b> to keep the picture's size, regardless of whether the picture is larger or smaller than the object. OR Select <b>Scale image to fit</b> to resize the picture to fit the object.</li></ol>

5. Optionally, drag the **Object transparency** slider to the right to make the object transparent.



**TIP**

You can also change an object's properties using the property selectors on the toolbar.

**To change an object's fill by first pressing the Fill button**

1. Press **Fill** , and then select a color.
2. Select the object.
3. Repeat step 2 for each object you want to apply the fill to.

**Filling digital ink drawings**

In addition to filling shapes, regular polygons and irregular polygons, you can fill areas enclosed by digital ink using the *Fill* button.

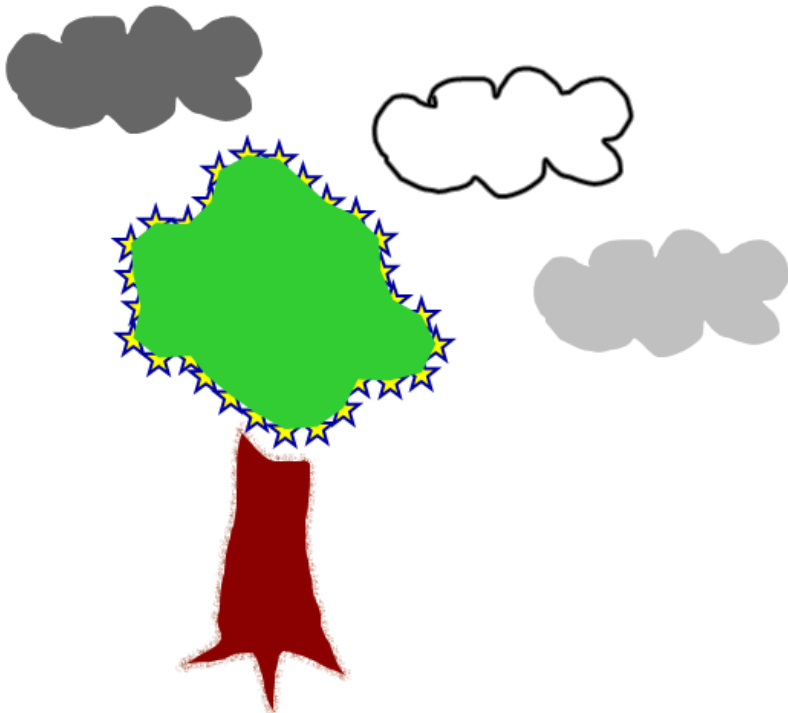

 **NOTES**

- To fill an area, you must enclose it with a single digital ink path.
- You're unable to fill an enclosed area if that area is part of a group (see *Grouping objects* on page 77).
- When you fill an enclosed area, the fill becomes a separate object, which you can move away from the original enclosed area. You can fill the enclosed area and move the resulting fill object multiple times.

## Changing other properties

In addition to fill, you can change objects' line style and text style.

### To change an object's line style

1. Select the object.
2. If the Properties tab isn't visible, press **Properties** .
3. Press **Line Style**.
4. Change the object's line style.

### To change an object's text style

1. Select the object.
2. If the Properties tab isn't visible, press **Properties** .
3. Press **Text Style**.
4. Change the object's text style (see *Formatting text* on page 43).

## Saving tool settings

When you select a tool in the toolbar, you can change its default settings using the Properties tab and then save your changes by clicking **Save Tool Properties**.

When you save your changes to a tool's default settings, the tool's button displays those changes:

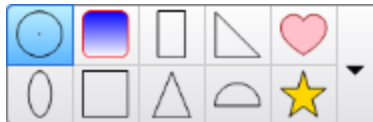

To restore the default settings, see *Customizing the toolbar* on page 189.

## Positioning objects

You can change the position of an object by moving it to another area of the existing page or to another page. You can also align objects and change the order of stacked objects.

## Moving objects

You can move objects to another position on the page. You can also flick objects.

### NOTE

You're unable to move an object if it's locked in place (see *Locking objects* on page 114).

### TIP

You can manipulate multiple objects by selecting them, and then creating a group (see *Grouping objects* on page 77).

### To move an object or objects

1. Select the object or objects.
2. Drag the object or objects to a new position on the page.

### TIP

You can move an object in small increments by pressing the arrow keys on your keyboard.

### To move an Adobe Flash® Player compatible file

1. Press the colored bar at the top of the Adobe Flash Player compatible file.
2. Drag the file to its new position.

### To flick an object

1. Select the object.
2. Quickly flick your finger in any direction.

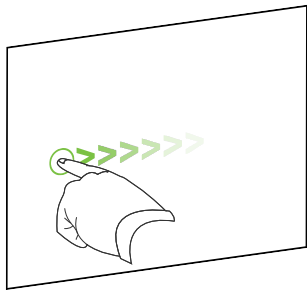





## Moving objects to another page

You can move objects to another page in a file.

### To move an object or objects to another page

1. If the Page Sorter isn't visible, press **Page Sorter** .
2. If you don't see the page that you want to move the object to, scroll in the Page Sorter until you see the page's thumbnail.
3. Select the object or objects you want to move.
4. Drag the object or objects into the Page Sorter above the thumbnail of the page you want to move the objects to.

### To move an Adobe Flash Player compatible file to another page

1. If the Page Sorter isn't visible, press **Page Sorter** .
2. If you don't see the page that you want to move the object to, scroll in the Page Sorter until you see the page's thumbnail.
3. Press the colored bar at the top of the Adobe Flash Player compatible file.
4. Drag the file into the Page Sorter above the thumbnail of the page you want to move the object to.

## Aligning objects









You can use the Alignment Tools add-on to align and distribute objects on a page. You can align selected objects on the bottom, left, right, top, vertically or horizontally. You can also align stacked objects vertically or horizontally.

If you want, you can display guidelines on a page to assist you in manually aligning objects with other objects, as well as the page's vertical and horizontal centers. You can also set objects to align automatically with these guidelines when you move the objects on a page (see page 66).

### To align objects on a page

1. Select the objects you want to align (see *Selecting objects* on page 60).
2. Press **Add-ons**  on the toolbar to display the Alignment Tools buttons.

3. Press an alignment button:

Button	Name	Select this button to:
	Align bottom	Align selected objects along their bottom edge.
	Align left	Align selected objects along their left edge.
	Align middle X	Align selected objects vertically through the middle of the objects.
	Align middle Y	Align selected objects horizontally through the middle of the objects.
	Align right	Align selected objects along their right edge.
	Align top	Align selected objects along their top edge.
	Stack horizontally	Align selected stacked objects horizontally.
	Stack vertically	Align selected stacked objects vertically.

### To display guidelines

1. Select **View > Alignment**.

The *Alignment* dialog box appears.

2. Select check boxes to specify which guidelines you want to display:

Check box	Select this check box to:
<b>Show guides for active objects</b>	Display a guideline when you move an object into alignment with another object.
<b>Show vertical page center guide</b>	Display a guideline when you move an object into alignment with the page's vertical center.
<b>Show horizontal page center guide</b>	Display a guideline when you move an object into alignment with the page's horizontal center.
<b>Snap objects to guides</b>	Automatically align objects to guidelines when you move the objects on a page.

3. If you want to change the color of the guidelines, press the colored bar to the left of *Guide color*, and then select a color.
4. Press **OK**.

## Rearranging stacked objects

If objects overlap on a page, you can rearrange the order of the stack (that is, you can control which objects appear in front of others).

### NOTE

You're unable to move an object in the stack if it's locked in place (see *Locking objects* on page 114).

#### To move an object to the front of the stack

1. Select the object.
2. Press the object's menu arrow, and then select **Order > Bring to Front**.

#### To move an object to the back of the stack

1. Select the object.
2. Press the object's menu arrow, and then select **Order > Send to Back**.

#### To move an object one place forward in the stack

1. Select the object.
2. Press the object's menu arrow, and then select **Order > Bring Forward**.

#### To move an object one place backward in the stack

1. Select the object.
2. Select the object's menu arrow, and then select **Order > Send Backward**.

## Cutting, copying and pasting objects

You can cut, copy and paste objects—including text, pictures, straight lines, arcs and shapes—in a .notebook file.

### TIPS

- You can paste text from other programs into SMART Notebook software and cut text from SMART Notebook software and paste it into other programs (see *Cutting, copying and pasting content from other programs* on page 91 and *Cutting and pasting text* on page 47).
- You can create an exact copy of an object by cloning it (see *Cloning objects* on page 72).

### To cut and paste an object

1. Select the object.
2. Press the object's menu arrow, and then select **Cut**.

#### TIP

Alternatively, you can press **Cut**  if you added this button to the toolbar (see *Customizing the toolbar* on page 189).

3. If you want to paste the object onto a different page, display that page.
4. Press **Paste** .

### To copy and paste an object

1. Select the object.
2. Press the object's menu arrow, and then select **Copy**.

#### TIP

Alternatively, you can press **Copy**  if you added this button to the toolbar (see *Customizing the toolbar* on page 189).

3. If you want to paste the item onto a different page, display that page.
4. Press **Paste** .

## Cropping images with a mask

You can use a mask to crop images. The mask hides the section of the image you crop out instead of deleting it. This enables you to edit the mask if you want to crop a different section of the image. You can also unmask the image to restore the original image.

#### NOTE

You can crop raster images only. For example, you can crop raster pictures you insert from the Gallery or from your computer. You're unable to crop other types of objects.

### **To crop an image with a mask**

1. Select the image.
2. Press the image's menu arrow, and then select **Mask**.

A cropping mask appears on the image. Cropped out sections of the image are shaded gray.

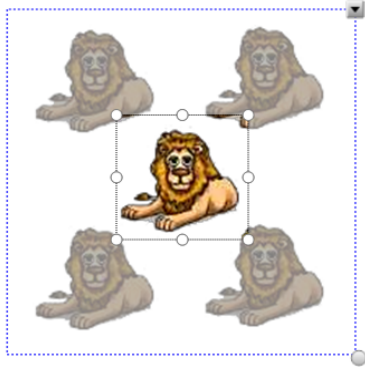

3. Drag the image until the section of the image you want to keep appears in the cropping mask.
4. Optionally, press one of the cropping mask's eight resize handles (the white circles), and then drag it to increase or reduce the cropping mask's size.
5. Press anywhere outside of the image to crop it.

### **To edit the mask**

1. Select the image.
2. Press the image's menu arrow, and then select **Edit Mask**.

A cropping mask appears on the image. Cropped out sections of the image are shaded gray.

3. Drag the image until the section of the image you want to keep appears in the cropping mask.
4. Optionally, press one of the cropping mask's eight resize handles (the white circles), and then drag it to increase or reduce the cropping mask's size.
5. Press anywhere outside of the image to crop it.

### **To restore the image**

1. Select the image.
2. Press the image's menu arrow, and then select **Unmask**.

The original image is restored.

## Cloning objects

You can create a duplicate of an object by using the Clone command, or you can create multiple copies of an object using the Infinite Cloner command.

### NOTE

You can also copy and paste objects, including text, images, straight lines, arcs and shapes (see *Cutting, copying and pasting objects* on page 69).

#### To clone an object

1. Select the object.
2. Press the object's menu arrow, and then select **Clone**.

A duplicate object appears on the page.

#### To clone an object using the Infinite Cloner

1. Select the object.
2. Press the object's menu arrow, and then select **Infinite Cloner**.
3. Select the object again.

An infinity symbol appears instead of the object's menu arrow.

4. Drag the object to another position on the page.
5. Repeat step 4 as many times as you want.
6. When you finish cloning the object, select the original object.
7. Press the infinity symbol, and then clear the selection of **Infinite Cloner**.

## Resizing objects

You can resize objects on a page by using the resize handle or the scale gesture (if your interactive product supports multitouch gestures).

### NOTE

You're unable to resize an object if it's locked in place (see *Locking objects* on page 114).

## Using the resize handle

### To resize an object

1. Select the object.
2. Press the object's resize handle (the gray circle), and then drag it to increase or reduce the object's size.



#### NOTE

To keep the shape's original height-to-width ratio, hold down SHIFT while you drag the resize handle.

### To resize multiple objects

1. Group the objects (see *Grouping objects* on page 77), and then select the group.  
A selection rectangle appears around the group.
2. Press the resize handle in the lower-right corner of the selection rectangle.
3. Drag the resize handle to increase or reduce the size of the objects.

## Using the scale gesture

### To resize an object from its center

1. Select the object.
2. Using one finger on each hand, press the screen at opposite ends of the object.

3. Drag your fingers in opposite directions to increase the object's size.

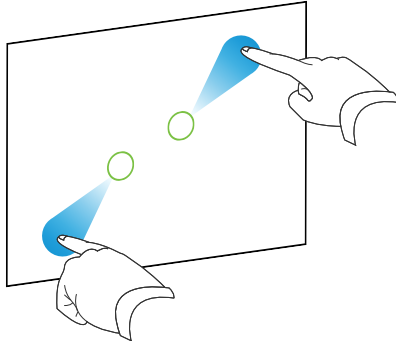

OR

- Drag your fingers toward each other to decrease the object's size.

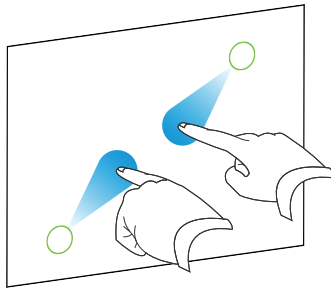

#### **To resize an object from its corner or side**

1. Select the object.
2. Using one finger on each hand, press the screen at the corner or side you want to resize the object from.
3. Drag your fingers in opposite directions to increase the object's size.

OR

- Drag your fingers toward each other to decrease the object's size.

#### **To resize multiple objects**

1. Select the objects.
2. Using one finger on each hand, press the screen at opposite ends of one of the objects.



3. Drag your fingers in opposite directions to increase the objects' size.

OR

Drag your fingers toward each other to decrease the objects' size.



#### NOTE

The objects resize from their centers regardless of where you press the screen.

## Rotating objects

You can rotate objects on a page by using the rotation handle or the rotate gesture (if your interactive product supports multitouch gestures).



#### NOTES

- You're unable to rotate an object if it's locked in place (see *Locking objects* on page 114).
- You're unable to rotate tables.

## Using the rotation handle

### To rotate an object

1. Select the object.
2. Press the object's rotation handle (the green circle), and then drag it in the direction you want to rotate the object.

### To rotate multiple objects

1. Select the objects.  
A selection rectangle appears around each object.
2. Press the rotation handle (the green circle) on any one of the selected objects, and then drag it in the direction you want to rotate the object. When you rotate one object, all other selected objects rotate automatically.

## Using the rotate gesture

### **■** To rotate an object around its center

1. Select the object.
2. Using one finger on each hand, press the screen at opposite ends of the object.
3. Move your fingers in a circle around the center of the object to rotate it.

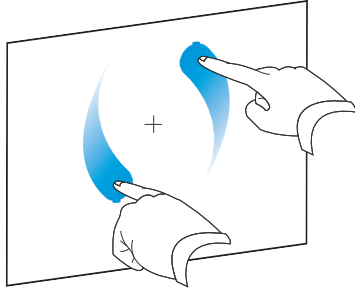

### **■** To rotate an object around a corner

1. Select the object.
2. Using one finger on each hand, press the screen in the corner you want to rotate the object around.
3. Move your fingers in a circle around the corner to rotate the object.

### **■** To rotate multiple objects

1. Select the objects.
2. Using one finger on each hand, press the screen at opposite ends of one of the objects.
3. Move your fingers in a circle.



#### **NOTE**

The objects rotate around their centers regardless of where you press the screen.

## Flipping objects

You can flip an object on a page.

### NOTE

You're unable to flip an object if it's locked in place (see *Locking objects* on page 114).

#### To flip an object

1. Select the object.
2. Press the object's menu arrow, and then select **Flip > Up/Down** or **Flip > Left/Right**.

#### To flip multiple objects

1. Select the objects.
2. Press the menu arrow on any one of the selected objects, and then select **Flip > Up/Down** or **Flip > Left/Right**.

## Grouping objects

You can create a group of objects, which lets you interact with all grouped items at the same time. After you create a group, you can select, move, rotate or resize the group as if it were an individual object. However, if you want to interact with an individual object in a group, you must ungroup the objects first.

### Grouping objects manually

You can group and ungroup objects manually using the menu or the shake gesture.

#### Using the menu

#### To group objects

1. Select the objects.
2. Press the menu arrow of any one of the selected objects, and then select **Group > Group**.

#### To ungroup objects

1. Select the group.
2. Press the group's menu arrow, and then select **Group > Ungroup**.

## Using the shake gesture



### NOTES

- You're unable to use the shake gesture with a mouse.
- The shake gesture works only when you initially contact your interactive product's surface.

### To group objects

Quickly shake your finger over the objects three times.

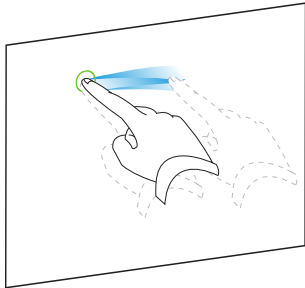

### To ungroup objects

Quickly shake your finger over the group three times.

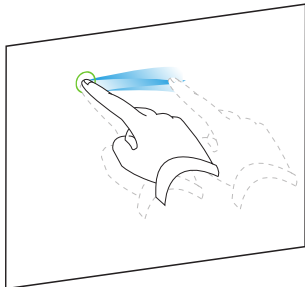

## Grouping objects automatically

If you write or draw multiple lines, SMART Notebook software automatically combines the lines into a single object. For example, if you write the letters of a word, SMART Notebook software combines the individual letters, enabling you to interact with the whole word. If you want to write words on the same line but don't want them combined, leave a large gap between them, use different pens, or briefly put the pen in the pen tray before writing another word (interactive whiteboards only).

If SMART Notebook software combined lines that you want to manipulate individually, ungroup the lines as described above.

## Deleting objects

Although you can erase digital ink (see *Erasing digital ink* on page 37), you're unable to erase some types of objects, including text, shapes, straight lines, arcs and pictures. To remove these types of objects from a page, you must delete them.

### NOTE

You're unable to delete an object if it's locked in place (see *Locking objects* on page 114). To delete a locked object from a page, you must unlock it.

### To delete an object

1. Select the object.
2. Press the object's menu arrow, and then select **Delete**.



## Chapter 6

# Inserting, organizing and sharing content

Inserting content from the Gallery .....	82
Inserting content from GeoGebra .....	84
Inserting content from the SMART Exchange website .....	85
Inserting content from other sources .....	86
Inserting pictures .....	86
Inserting pictures from files .....	86
Inserting pictures from a scanner .....	87
Inserting pictures from a SMART Document Camera .....	87
Working with pictures .....	87
Creating transparent areas in a picture .....	87
Inserting multimedia files .....	88
Inserting Adobe Flash Player compatible files .....	88
Inserting Adobe Flash Player compatible video files .....	90
Inserting sound files .....	90
Working with multimedia files .....	90
Installing encoders for additional formats .....	91
Inserting content from other programs .....	91
Cutting, copying and pasting content from other programs .....	91
Importing content using SMART Notebook Print Capture .....	92
Importing content using SMART Notebook Document Writer .....	93
Importing PowerPoint files .....	94
Importing files from other interactive whiteboard programs .....	95
Inserting equations with the Math Editor .....	96
Inserting Internet browsers .....	98
Inserting an Internet browser .....	98
Configuring proxy servers .....	99
Attaching files and web pages .....	99
Organizing and sharing content using the Gallery .....	101
Adding content to the Gallery .....	101
Organizing content in the Gallery .....	103
Sharing content with other teachers .....	104
Connecting to Team Content categories .....	105

Sharing content using the SMART Exchange website .....106

---

You can insert pictures, multimedia files and other content into your .notebook files from a variety of sources. These sources include the Gallery, the SMART Exchange® website and the Internet.

After inserting your content, you can organize it using the Gallery and share it with other teachers using the Gallery or the SMART Exchange website.

## Inserting content from the Gallery

The Gallery is a tab in the SMART Notebook software user interface where you can browse or search for content and then add that content to your .notebook files.

The Gallery contains Lesson Activity Examples, which includes Activity Builder examples (see *Creating a matching lesson activity* on page 122), interactive techniques and 3D models to aid you in creating lesson activities.

When your system administrator installs SMART Notebook software, he or she can install the following additional items:

- Gallery Essentials is a collection of thousands of pictures, multimedia objects and more, organized into subject-specific categories.
- Lesson Activity Toolkit is a collection of customizable tools and templates that you can use to create professional-looking and interactive lessons. The toolkit helps you create engaging content like word games, quizzes and sorting activities. It also offers Adobe Flash Player compatible files like hide-and-reveal and drag-and-drop.

The Gallery is divided into two sections. The top section of the Gallery is the category list. When you select a category or subcategory in the list, its contents appear in the bottom section of the Gallery.

### TIP

You can change the size of the category list and content list by pressing the boundary between them, and then dragging it up or down.



You can browse the category list to view the contents of each category. Thumbnails in the categories provide preview images of the content.

- In *Pictures*, pictures appear as thumbnails.
- In *Interactive and Multimedia*, video objects appear as a single frame from the videos, sound objects appear with a speaker icon in the lower-left corner, and Adobe Flash Player compatible files appear as an Adobe Flash icon or thumbnail of the content with a small Adobe Flash icon in the upper-left corner.
- In *3D Objects*, 3D models appear as thumbnails.
- In *Notebook Files and Pages*, files appear as binders and pages appear with a folded upper-right corner.
- In *Backgrounds and Themes*, backgrounds appear as pages with a folded lower-right corner and themes appear as thumbnails.

You can search for a Gallery item using the keyword search.

After browsing or searching for a Gallery item, you can add it to your .notebook file.

### To browse the Gallery

1. If the Gallery isn't visible, press **Gallery** .
2. Press a category's plus sign to view its subcategories.





#### NOTE

You can close a category by pressing the category's minus sign.

3. Select a category or subcategory to display its contents.

### To search the Gallery

1. If the Gallery isn't visible, press **Gallery** .
  2. Type a keyword into the *Type search terms here* box, and then press **Search** .
- The Gallery displays all content containing the keyword.

### To add a Gallery item to your .notebook file

1. If the Gallery isn't visible, press **Gallery** .
2. Browse or search for the Gallery item you want to add.

3. Double-click the Gallery item's thumbnail.
  - If you add a picture, Adobe Flash Player compatible file, video file or sound file, it appears on the current page.
  - If you add a background, it replaces the page's existing background (see *Applying page backgrounds and themes* on page 118).
  - If you add a page from a .notebook file, SMART Notebook software inserts it before the current page.
  - If you add a .notebook file, SMART Notebook software inserts the file's pages before the current page.

## Inserting content from GeoGebra

GeoGebra is an interactive mathematics software for all levels of education. When you insert the GeoGebra widget in SMART Notebook software, you can explore geometry, algebra, tables, graphing, statistics and calculus with your students.

You can also search for worksheets from GeoGebraTube using the keyword search. After searching for a worksheet, you can add it to your .notebook file. GeoGebraTube ([geogebra.org](http://geogebra.org)) contains thousands of worksheets created and shared by other teachers.

### NOTE

For more information on how to use GeoGebra software, go to the GeoGebra Wiki ([wiki.geogebra.org](http://wiki.geogebra.org)).

#### To access the GeoGebra widget

Press **Add-ons** , and then press **GeoGebra**.

#### To insert the GeoGebra widget

1. If the GeoGebra widget isn't visible, press **Add-ons** , and then press **GeoGebra**.
2. Select **Insert GeoGebra Widget**.

#### To search GeoGebraTube

1. If the GeoGebra widget isn't visible, press **Add-ons** , and then press **GeoGebra**.
2. Type a keyword into the *Search in Free Materials* box, and then press **Search**.

The GeoGebra widget displays thumbnail images of worksheets containing the keyword.

### To add a GeoGebraTube worksheet to your .notebook file

1. If the GeoGebra widget isn't visible, press **Add-ons** , and then press **GeoGebra**.
2. Search for the GeoGebraTube worksheet you want to add.
3. Press the worksheet's thumbnail, and then select **Insert GeoGebra Widget**.

The worksheet appears on the current page.



#### TIP

For more information on a worksheet, press the thumbnail's title to go to the worksheet's download page in GeoGebraTube.

## Inserting content from the SMART Exchange website

The SMART Exchange website ([exchange.smarttech.com](http://exchange.smarttech.com)) includes thousands of lesson plans, question sets, widgets and other content that you can download and then open in SMART Notebook software.



#### NOTE

You can also share your lesson plans with other teachers through the SMART Exchange website. For more information, see *Sharing content using the SMART Exchange website* on page 106.

### To insert content from the SMART Exchange website

1. Press **SMART Exchange** .

The SMART Exchange website opens in your web browser.

2. If you're new to the SMART Exchange website, press **Join for free**, and then follow the on-screen instructions to create an account.

OR

If you have an account, press **Sign In**, and then follow the on-screen instructions to log on to the SMART Exchange website with your account.

3. Search or browse for content, and then download it to your computer.
4. Import content into the Gallery (see *Sharing content with other teachers* on page 104).

## Inserting content from other sources

If you or other teachers in your school have created content outside of SMART Notebook software, you can include this content in your .notebook files. Specifically, you can do the following:

- Insert pictures, Adobe Flash Player compatible files and video files, and sound files
- Cut or copy, and then paste content from other programs
- Import content from other programs

### Inserting pictures

You can insert pictures into pages from files, a scanner or a SMART Document Camera.

#### NOTE

You can also insert pictures from the Gallery tab. For more information, see *Inserting content from the Gallery* on page 82.

After inserting a picture, you can define a transparent area in it.

### Inserting pictures from files

You can insert a picture into a page.

SMART Notebook software supports BMP, GIF, JPEG, PNG, TIFF and WMF formats.

#### To insert a picture from a file

1. Select **Insert > Picture**.

The *Insert Picture File* dialog box appears.

2. Browse to and select the picture you want to insert.

#### TIP

To select more than one picture, hold down CTRL and then select the pictures.

3. Press **Open**.

The picture appears in the upper-left corner of the page.

### Inserting pictures from a scanner

If a scanner is connected to your computer, you can insert pictures from the scanner into a page.

#### NOTE

You must install your scanner's driver and software on your computer before inserting pictures from the scanner into SMART Notebook software.

#### To insert a picture from a scanner

1. Select **Insert > Picture From Scanner**.  
The *Insert Scanned Picture* dialog box appears.
2. Select a scanner from the list.
3. Press **Scan**.
4. Follow the instructions included with your scanner to scan your picture.

### Inserting pictures from a SMART Document Camera

You can insert pictures from a SMART Document Camera into a page.

#### To insert a picture from a SMART Document Camera

1. Select **Insert > Picture From SMART Document Camera**.  
The *SMART Document Camera* window appears on the page.
2. Insert a picture following the instructions in the Help.

### Working with pictures

When you insert a picture in a .notebook file, the picture becomes an object in the file. Therefore, you can move, resize, rotate and make other changes to the picture like any other object.

For information on how to work with objects, including pictures, in .notebook files, see *Working with objects* on page 59.

### Creating transparent areas in a picture

You can create transparent areas in a picture that you insert into a page. This is useful for removing the picture's background. You can make any color in the picture transparent.

#### NOTE

You can reduce the size of a large picture when you insert it in a file (see *Setting image optimization preferences* on page 193). If you later create a transparent area in the picture, the picture is no longer optimized.

### To create a transparent area in a picture

1. Select the picture.
2. Press the picture's menu arrow, and then select **Set Picture Transparency**.

The *Picture Transparency* dialog box appears.

3. Drag the corners of the dialog box in or out to resize it.
4. Press any areas in the picture that you want to make transparent.



#### NOTE

Pressing an area makes only that area transparent, even if the picture includes that same color in other areas.

5. Press **OK**.

## Inserting multimedia files

You can insert multimedia files, including Adobe Flash Player compatible files, video files and sound files, into pages.



#### NOTE

You can also insert multimedia files from the Gallery tab. For more information, see *Inserting content from the Gallery* on page 82.

### Inserting Adobe Flash Player compatible files

You can insert Adobe Flash Player compatible files into a page.

After you insert an Adobe Flash Player compatible file into a page, or display a page that already contains an Adobe Flash Player compatible file, the file plays immediately. You can control the playback of the file. If the file has buttons, you can press them on your interactive product. If the file doesn't have buttons, you can use the options in the file's menu arrow.



#### NOTES

- Adobe Flash Player compatible files on a page must be self-extracting. You're unable to use Adobe Flash Player compatible files that load or rely on other Adobe Flash Player compatible files.
- You're unable to drag an Adobe Flash Player compatible file from an Internet browser into a page.
- If Adobe Flash Player isn't installed on your computer, SMART Notebook software notifies you when you insert an Adobe Flash Player compatible file into a page.

- You can install Adobe Flash Player by visiting [adobe.com](http://adobe.com), but you must use Internet Explorer® Internet browser to install it. If you use another browser, Adobe Flash Player compatible files don't work in SMART Notebook software.
- To write on top of an Adobe Flash Player compatible file with a handwriting recognition component, start writing outside the file and continue to write over the file. This enables SMART Notebook software to recognize the digital ink as a separate object from the Adobe Flash Player compatible file.

### To insert an Adobe Flash Player compatible file

1. Select **Insert > Adobe Flash Player Compatible File**.

The *Insert Flash File* dialog box appears.

2. Browse to and select the Adobe Flash Player compatible file that you want to insert into the page.
3. Press **Open**.

The Adobe Flash Player compatible file appears in the upper-left corner of the page.

### To control an Adobe Flash Player compatible file

1. Select the Adobe Flash Player compatible file.
2. Control the file by doing any of the following:
  - To play the file, press the file's menu arrow, and then select **Flash > Play**.
  - To play the file from the beginning, press the file's menu arrow, and then select **Flash > Rewind**.
  - To advance the file slightly and pause playback, press the file's menu arrow, and then select **Flash > Step Forward**.
  - To rewind the file slightly and pause playback, press the file's menu arrow, and then select **Flash > Step Back**.
  - To play the file continuously, press the file's menu arrow, and then select **Flash > Loop**.
  - To stop playing the file continuously, press the file's menu arrow, and then clear the selection of **Flash > Loop**.

### Inserting Adobe Flash Player compatible video files

You can insert Adobe Flash Player compatible video files into a page.

#### NOTE

SMART Notebook software supports the Adobe Flash Player compatible video file (FLV) format. If you want SMART Notebook software to support other file types, you can install additional encoders (see *Installing encoders for additional formats* on the next page).

### To insert an Adobe Flash Player compatible video file

1. Select **Insert > Video**.

The *Insert Video File* dialog box appears.

2. Browse to and select the Adobe Flash Player compatible video file that you want to insert into the page.
3. Press **Open**.

### Inserting sound files

You can attach a sound file to any object (except Adobe Flash Player compatible objects) in a .notebook file. For more information, see *Adding sounds to objects* on page 112.

### Working with multimedia files

When you insert a multimedia file in a .notebook file, the multimedia file becomes an object in the file. Therefore, you can move, resize, rotate and make other changes to the multimedia file like any other object.

For information on how to work with objects, including multimedia files, in .notebook files, see *Working with objects* on page 59.



### Installing encoders for additional formats

SMART Notebook software supports the FLV and MP3 formats. If you want SMART Notebook software to support other video and audio formats, you can install the following encoder. If you install this encoder, SMART Notebook software automatically detects it and supports its video and audio formats.

Encoder	Video formats	Audio formats	Link
MediaCoder Full Pack 0.3.9	<ul style="list-style-type: none"><li>• ASF</li><li>• AVI</li><li>• MOV</li><li>• MPEG and MPG</li><li>• WMV</li></ul>	<ul style="list-style-type: none"><li>• AIF and AIFF</li><li>• WAV</li></ul>	<a href="http://mediacoderhq.com/dlfull.htm">mediacoderhq.com/dlfull.htm</a>

#### NOTE

SMART Technologies ULC provides links to these programs as a courtesy, and makes no representations or warranties regarding the programs or any information related thereto. Any questions, complaints or claims regarding the programs must be directed to the appropriate software vendor.

### Inserting content from other programs

If you have content in other programs that you want to use in your .notebook files, you can move this content to SMART Notebook software by doing one of the following:

- Cutting or copying, and then pasting the content
- Importing the content

#### Cutting, copying and pasting content from other programs

You can cut or copy, and then paste content from other programs into SMART Notebook software.

##### To cut content from another program

1. In the other program, select the content you want to cut, and then select **Edit > Cut**.
2. In SMART Notebook software, press **Paste** .

##### To copy content from another program

1. In the other program, select the content you want to copy, and then select **Edit > Copy**.
2. In SMART Notebook software, press **Paste** .

### Importing content using SMART Notebook Print Capture

When you install SMART Notebook software on a computer with Windows XP operating system, you also install SMART Notebook Print Capture. SMART Notebook Print Capture works like any other printer driver, except it captures output in a .notebook file, instead of printing it on paper. Each page of an imported file appears as an object on its own page, with its original formatting and page breaks preserved.

#### NOTE

If you install SMART Notebook software on a computer with Windows 7 or Windows 8 operating system, you can import content using SMART Notebook Document Writer (see *Importing content using SMART Notebook Document Writer* on the next page).

### To use SMART Notebook Print Capture

1. In the source file you want to export to a .notebook file, select **File > Print**.

The *Print* dialog box appears.

2. Select **SMART Notebook Print Capture** in the list of printers.
3. Optionally, change the page orientation and graphics resolution (see *To change the page orientation and graphics resolution* below).
4. Specify a page range, and then press **OK** or **Print**.

If an existing .notebook file isn't open, a new .notebook file opens. Each page of the source file appears on a separate page.

OR

If an existing .notebook file is open, each page of the source file appears in the .notebook file after the current page.

#### NOTE

This process can take several minutes.

### To change the page orientation and graphics resolution

1. Press the **Properties** or **Preferences** button.

The *SMART Notebook Print Capture Properties* dialog box appears.

2. Select **Portrait** or **Landscape**.

3. Select a default resolution in the *Resolution* drop-down list.

OR

Select **CUSTOM Resolution** in the *Resolution* drop-down list, and then type numbers in the *Horizontal Resolution* and *Vertical Resolution* boxes.



#### TIPS

- Use the same value in both boxes to prevent image distortion.
- The higher the resolution, the larger the image.
- Don't use the **Draft**, **Low** or **Medium** options because they might not scale the image proportionally.

4. Press **OK**.

### Importing content using SMART Notebook Document Writer

When you install SMART Notebook software on a computer with Windows 7 or Windows 8 operating system, you also install SMART Notebook Document Writer. SMART Notebook Document Writer works like any other printer driver, except it captures output in a .notebook file, instead of printing it on paper.



#### NOTE

If you install SMART Notebook software on a computer with Windows XP operating system, you can import content using SMART Notebook Print Capture (see *Importing content using SMART Notebook Print Capture* on the previous page).

### To use SMART Notebook Document Writer

1. In the source file you want to export to a .notebook file, select **File > Print**.

The *Print* dialog box appears.

2. Select **SMART Notebook Document Writer** in the list of printers.
3. Optionally, change the page orientation (see *To change the page orientation* on the next page).
4. Specify a page range, and then press **OK** or **Print**.

A dialog box appears.

5. Select **SMART Notebook pages with images** to import the content of the file as pictures.

OR

Select **SMART Notebook page with editable objects** to import the content of the file as editable objects.



#### NOTE

If you choose to import the content as editable objects, some objects may not display correctly. You can import the content as pictures.

6. Press **OK**.

A new .notebook file opens. Each page of the source file appears on a separate page.

### To change the page orientation

1. Press **Properties** or **Preferences**.

The *Printing Preferences* dialog box appears.

2. Select **Landscape** or **Portrait** in the *Orientation* drop-down list.
3. Press **OK**.

### Importing PowerPoint files

You can import content into a .notebook file from a variety of sources, including PowerPoint files.



#### NOTE

SMART Notebook software doesn't import some gradient, pattern and picture effects. These effects may appear incorrectly in .notebook files as a result.



#### TIP

You can also export .notebook files to PowerPoint (see *Exporting files* on page 17).

### To import a PowerPoint file

1. Select **File > Import**.

The *Open* dialog box appears.

2. Select **All PowerPoint Files (\*.ppt;\*.pptx)** in the *Files of type* drop-down list.
3. Browse to and select the PowerPoint file you want to import.
4. Press **Open**.

SMART Notebook software adds the contents of the PowerPoint file to a .notebook file.

### Importing files from other interactive whiteboard programs

You can import content into .notebook files from a variety of sources, including other interactive whiteboard programs.

If the other interactive whiteboard programs support the Interactive Whiteboard Common File Format (CFF), you can export a CFF file from those programs and then import that CFF file into SMART Notebook software.

Otherwise, you can attempt to import the other interactive whiteboard programs' native file formats.

#### NOTE

You can also export CFF files (see *Exporting files* on page 17).

### To import CFF files

1. Select **File > Import**.

The *Open* dialog box appears.

2. Select **All Common File Format Files (\*.iwb)** in the *Files of type* drop-down list.
3. Browse to and select the file you want to import.
4. Press **Open**.

The file opens.

### To import other files

1. Press **Open File** .

The *Open* dialog box appears.

2. Select **All Files (\*.\*)** in the *Files of type* drop-down list.
3. Browse to and select the file you want to import.
4. Press **Open**.

If you import a file that SMART Notebook software supports, the file opens.



OR

If you import a file that SMART Notebook software doesn't support, SMART Notebook software adds it to the Attachments tab. You can open these attached files using third-party software, but you're not able to add them to a page.

## Inserting equations with the Math Editor

You can use the Math Editor to insert a handwritten equation to a page in a more readable format. The Math Editor recognizes your handwriting and automatically converts it to a typeset format. You can also add the recognized equation to a GeoGebra worksheet if the equation is in a supported graph format.

### To insert an equation to the page

1. Press **Add-ons** , and then select **Insert Equation** .

The Math Editor appears.

2. Select a pen tool and color (see page 34).
3. Write a math equation on the graph paper section of the editor.

The handwritten equation converts to a typed equation, which appears below the graph paper section. Accept and reject icons appear beside the recognized equation.

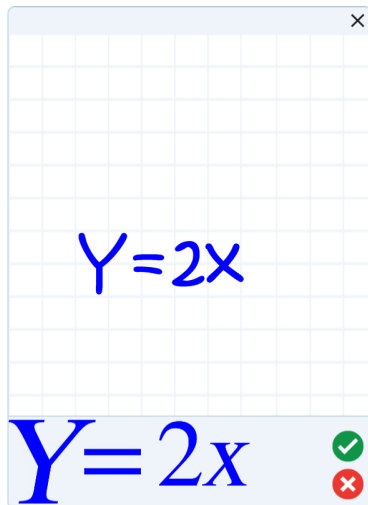

4. Press  to accept the recognized equation.

The typed equation appears on the page.

OR

Press  to reject the recognized equation and close the Math Editor.

### To edit the recognized equation

1. Press **Select** , and then press the recognized equation on the page twice.

The handwritten equation appears on the Math Editor.

2. Edit the handwritten equation with the Eraser tool and a pen tool.

The edited equation is recognized and appears below the graph paper section. Accept and reject icons appear beside the recognized equation.

3. Press  to accept the recognized equation.

The equation updates with your edits.

OR

Press  to reject the recognized equation and close the Math Editor.

The equation doesn't update.

### To add the recognized equation to a GeoGebra worksheet

1. Insert a GeoGebra worksheet on the page (see *Inserting content from GeoGebra* on page 84).
2. Drag the equation from the page to the GeoGebra widget.

The equation is automatically graphed in the worksheet.

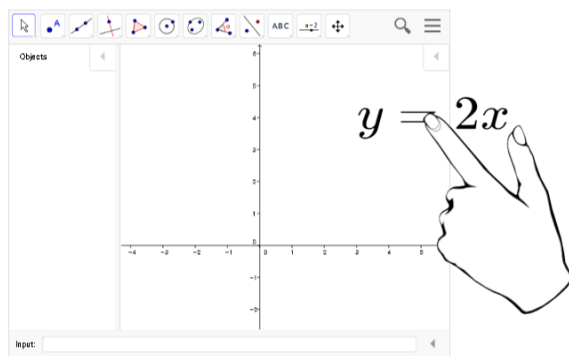

## Inserting Internet browsers

You can insert an Internet browser into a .notebook page. In the Internet browser, you can browse to and display web pages. You can modify the Internet browser like any other object in SMART Notebook software (see *Working with objects* on page 59).

### NOTE

When you resize an Internet browser, the Internet browser's content scales automatically so that you always see the entire web page that you are viewing.

## Inserting an Internet browser

### To insert an Internet browser

1. Select **Insert > Internet Browser**.







An Internet browser appears.

2. Double-click the address bar, type the address of the web page you want to browse to, and then press **Go** .

### TIP

If there's no keyboard connected to your computer, click **SMART Keyboard**  to display an on-screen keyboard.

3. Interact with the website using the buttons in the Internet browser toolbar:

Button	Command	Action
	Back	Display the previous web page.
	Forward	Display the next web page.
	Return to Pinned Page	Open the pinned web page.
	Pin Page	Pin the current web page. When you first open the .notebook file, the pinned web page appears in the Internet browser. You can return to the pinned page at any time by pressing <b>Return to Pinned Page</b>  .
	Reload	Reload the current web page.
	Move Toolbar	Change the position of the Internet browser toolbar.



## Configuring proxy servers

Internet browsers in SMART Notebook software work with any proxy server that adheres to the RFC 2068 HTTP standard. If your system administrator installed SMART Notebook software behind a proxy server, he or she must create access policy rules for inbound and outbound traffic on that proxy server. Your system administrator can further enhance network security by enabling authentication, such as basic or NT LAN Manager (NTLM) authentication.

### NOTE

Although proxy servers protect internal networks from intruders, they unavoidably introduce network latency.

## Attaching files and web pages

You can attach copies of files, shortcuts to files and links to web pages using the Attachments tab.

Attaching files or web pages enables you to find and open these items easily while presenting a .notebook file.

### NOTES

- You can also link a file or web page to an object on a page (see *Adding links to objects* on page 110).
- As an alternative to attaching a link to a web page, you can also insert an Internet browser in your .notebook file (see *Inserting Internet browsers* on the previous page).

### To attach a copy of a file

1. If the Attachments tab isn't visible, press **Attachments**  .
2. Press **Insert** at the bottom of the *Attachments* tab, and then select **Insert Copy of File**.  
The *Insert Copy of File* dialog box appears.
3. Browse to and select the file you want to attach.

4. Press **Open**.

The file's name and size appear in the *Attachments* tab.



#### NOTE

When you attach a file, the size of the .notebook file increases. Although SMART Notebook software compresses files to conserve space, SMART Notebook software can compress some file types more than others.

### To attach a shortcut to a file

1. If the Attachments tab isn't visible, press **Attachments** .
2. Press **Insert** at the bottom of the *Attachments* tab, and then select **Insert Shortcut to File**.  
The *Insert File Shortcut* dialog box appears.
3. Browse to and select the file you want to attach.
4. Press **Open**.

The file name and *Shortcut* appear in the *Attachments* tab.



#### NOTES

- SMART Notebook software doesn't export shortcuts. If you want to export file attachments, attach a copy of your file, not a file shortcut.
- Make sure that the file is accessible on the computer you will use during the lesson.

### To attach a link to a web page

1. If the Attachments tab isn't visible, press **Attachments** .
2. Press **Insert** at the bottom of the *Attachments* tab, and then select **Insert Hyperlink**.  
The *Insert Hyperlink* dialog box appears.
3. Type the web page's address in the *Hyperlink* box.
4. Type a name for the link in the *Display name* box.
5. Press **OK**.

The display name and *URL* appear in the *Attachments* tab.

### To open a file or web page from the Attachments tab

1. If the Attachments tab isn't visible, press **Attachments**  .

The Attachments tab lists all attachments in the open file.

- If an attached item is a copy of a file, the file's size appears in the *Size* column.
  - If an attached item is a shortcut to a file, *Shortcut* appears in the *Size* column.
  - If an attached item is a link to a web page, *URL* appears in the *Size* column.
2. To open a file, double-click the file name or shortcut.

OR

To open a web page, double-click the link.

## Organizing and sharing content using the Gallery

The Gallery is a tab in the SMART Notebook software user interface where you can browse or search for content and then add that content to your .notebook files. The Gallery consists of a set of categories, one of which is the My Content category.

If you find you use the same content across multiple .notebook files, you can add this content to the My Content category. You can share content from the My Content category with other teachers in your school by importing or exporting Gallery collection files. You can also connect to a Team Content category containing content that you and other teachers in your school contribute to.

After adding your content to the Gallery, you can insert it into .notebook files as described in *Inserting content from the Gallery* on page 82.

### Adding content to the Gallery

You can add SMART Notebook software objects and pages as well as supported files to the My Content category in the Gallery.

### To add an object to the Gallery

1. If the Gallery isn't visible, press **Gallery**  .
2. Select the object that you want to add to the Gallery.

3. Drag the object from the page to the Gallery's *My Content* category or one of its subcategories.



#### NOTES

- You're unable to drag an object if it's locked in place (see *Locking objects* on page 114).
- If you want to change a Gallery item's name, select the item, press its menu arrow, and then select **Rename**.

### To add a page to the Gallery

1. Create and modify objects on the page until the page appears exactly as you want it to.
2. Select **File > Export Page as Gallery Item**.

The *Save Page as Gallery Item* dialog box appears.

3. Browse to the folder where you want to save the page.
4. Type a name for the page in the *File name* box.
5. Press **Save**.
6. If the Gallery isn't visible, press **Gallery** .
7. Select **My Content** (or one of its subcategories) in the Gallery's category list, press its menu arrow, and then select **Add to My Content**.

The *Add to My Content* dialog box appears.

8. Browse to and select the item that you saved in step 5.
9. Press **Open**.

### To add a supported file to the Gallery

1. If the Gallery isn't visible, press **Gallery** .
2. Select **My Content** (or one of its subcategories) in the Gallery's category list, press its menu arrow, and then select **Add to My Content**.

The *Add to My Content* dialog box appears.

3. Browse to and select the item you want to add to the Gallery.

4. Press **Open**.



**NOTE**

By default, SMART Notebook software names the new Gallery item based on the original file name. If you want to change the item's name, select the Gallery item's thumbnail, press its menu arrow, and then select **Rename**.

## Organizing content in the Gallery

As you add objects, pages and supported files to the My Content category in the Gallery, you may want to reorganize the category's structure. You can create subcategories and move Gallery items between subcategories.

### To create a subcategory

1. If the Gallery isn't visible, press **Gallery** .
2. Select **My Content** (or one of its subcategories) in the Gallery's category list, press its menu arrow, and then select **New Folder**.

A new subcategory appears.

3. Type a name for the new subcategory, and then press ENTER.

### To rename a subcategory

1. If the Gallery isn't visible, press **Gallery** .
2. Select **My Content** in the Gallery's category list, and then browse to the subcategory that you want to rename.
3. Select the subcategory, press its menu arrow, and then select **Rename**.
4. Type a new name for the subcategory, and then press ENTER.

### To move a Gallery item to a different subcategory

1. If the Gallery isn't visible, press **Gallery** .
2. Browse to the category that contains the Gallery item you want to move.  
The Gallery displays the contents of the category.
3. Drag the item to another subcategory.

## Sharing content with other teachers

Importing and exporting collection files is an ideal way to share custom categories with other teachers and to use categories that other teachers have created. You can use collection files to add items to the My Content category in the Gallery. After you import a collection file, all of its items appear in the Gallery as a new subcategory.

### To import a collection file from another teacher

1. If the Gallery isn't visible, press **Gallery** .
2. Select **My Content** (or one of its subcategories) in the Gallery's category list, press its menu arrow, and then select **Add to My Content**.

The *Add to My Content* dialog box appears.

3. Browse to the folder that contains the collection file you want to import.



#### NOTE

A collection file has a .gallery extension.

4. Select the collection file, and then press **Open**.

The collection appears as a new subcategory.

### To export a collection file to share with other teachers

1. Select the category that contains the items you want to save in a collection.



#### NOTE

SMART Notebook software exports the selected category but doesn't export any of its subcategories.

2. Press the category's menu arrow, and then select **Export as Collection File**.

The *Save As* dialog box appears.

3. Browse to the folder where you want to save the collection file.
4. Type a name for the file in the *File name* box.
5. Press **Save**.



## Connecting to Team Content categories

The Team Content categories feature enables you to connect to Gallery content in a shared location on your school's network. Multiple teachers can connect to the same folder. SMART Notebook software automatically updates your changes for all other teachers.

### NOTE

Your access permissions for the Team Content category are the same as your folder access permissions on your school's network. If you have full access to a folder on the network, you can add or remove items in that folder's Team Content category. However, if you have read-only access to the folder, you can copy items from the Team Content category, but you're unable to add, edit or remove items.

### To connect to a Team Content category

1. If the Gallery isn't visible, press **Gallery** .
2. Press **Show additional Gallery actions** , and then select **Connect to Team Content**.

The *Browse For Folder* dialog box appears.

3. Browse to and select the folder containing the Team Content category you want to connect to, and then press **OK**.

The Team Content category appears in the Gallery.

### To contribute to a Team Content category

Add content to a Team Content category as you do to the My Content category (see *Adding content to the Gallery* on page 101).

## Sharing content using the SMART Exchange website

In addition to sharing your content with other teachers in your school (see *Sharing content with other teachers* on page 104), you can share .notebook files with teachers from around the world using the SMART Exchange website ([exchange.smarttech.com](http://exchange.smarttech.com)).

### To share a .notebook file on the SMART Exchange website

1. Open the .notebook file you want to share.
2. Select **File > Share on SMART Exchange**.  
A dialog box appears.
3. If you're new to the SMART Exchange website, press **Not a member yet**, and then follow the on-screen instructions to create an account.

OR

If you have an account, type your e-mail address in the *Email Address* box and your password in the *Password* box, and then press **Sign In**.



#### TIPS

- If you forgot your password, click **Forgot your password**, and then follow the on-screen instructions to reset it.
- If you don't want to log on to the SMART Exchange website each time you share content, select the **Keep me signed in** check box.

4. Enter the appropriate information:

Control	Instructions
<b>Enter resource details</b>	Type a title for the .notebook file.
<b>Description</b>	Type a description of the .notebook file.
<b>Subject(s)</b>	Select the subjects that the .notebook file is applicable to.
<b>Grade(s)</b>	Select the grades that the .notebook file is applicable to.
<b>Search terms</b>	Type words or phrases that other SMART Exchange users will likely enter to search for the .notebook file. Separate the words or phrases with commas.

5. Read the sharing agreement.
6. If you accept the sharing agreement, press **Agree and Submit**.



## Chapter 7

# Creating lesson activities

Using advanced object features .....	108
Creating custom Creative pen styles .....	108
Adding links to objects .....	110
Adding sounds to objects .....	112
Animating objects .....	114
Locking objects .....	114
Using advanced page features .....	115
Displaying student page borders .....	116
Recording pages with the Lesson Recorder .....	116
Applying page backgrounds and themes .....	118
Applying backgrounds using the Properties tab .....	118
Applying backgrounds and themes using the Gallery .....	120
Creating themes .....	121
Creating example lesson activities .....	121
Creating a matching lesson activity .....	122
Creating a hide-and-show lesson activity .....	124
Creating a reveal lesson activity .....	126
Creating other types of lesson activities .....	128

---

Using SMART Notebook software, you can not only present information to students but also engage them in interactive lesson activities.

You can create lesson activities by inserting objects such as shapes, pictures and tables, and using features such as the Activity Builder and scaling gesture.

This section documents the advanced features you can use to create lesson activities and shows you how to create a set of example lesson activities. You can use these example lesson activities or develop your own. You can also use resources available to you in the Gallery and SMART Exchange website.

## Using advanced object features

You can use the following advanced object features when creating lesson activities:

- Custom creative pen styles
- Object links
- Object sounds
- Object animation
- Link a tool to an object

You can also lock any objects that you don't want moved or otherwise modified during the presentation of a lesson activity.

### Creating custom Creative pen styles

SMART Notebook software includes eight Creative pen styles (see *Writing or drawing digital ink* on page 34). In addition to these styles, you can create your own styles using pictures or objects on the currently selected page.



#### **To create a custom Creative pen using a picture**

1. Press **Pens** .

The Pens tool buttons appear.

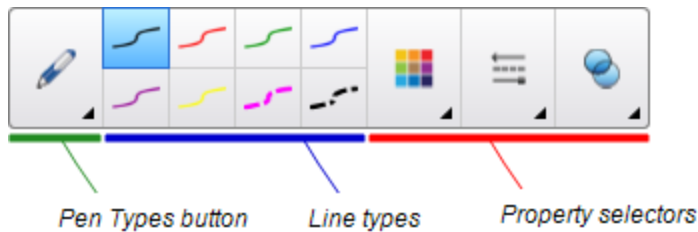

2. Press **Pen Types**, and then select **Creative Pen**.
3. Select a line type.
4. If the Properties tab isn't visible, press **Properties** .
5. Press **Line Style**.
6. Select **Use a custom stamp image**.
7. Click **Browse**.

The *Insert Image File* dialog box appears.

8. Browse to and select the picture you want to use for the Creative pen style.
9. Press **Open**.
10. Write or draw digital ink on the page.



**TIP**

- To resume using the default line type, select **Use the default pattern**.
- If you want to save your custom Creative pen style for future use, press **Save Tool Properties**. You can later reset the Creative pen style (see *Customizing the toolbar* on page 189).

**To create a custom Creative pen using an object**

1. Press **Pens** .

The Pens tool buttons appear.

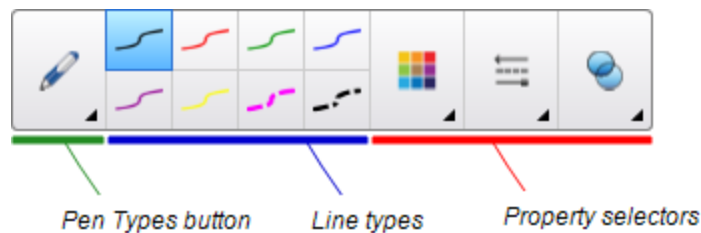

2. Press **Pen Types**, and then select **Creative Pen**.
3. If the Properties tab isn't visible, press **Properties** .
4. Press **Line Style**.
5. Select **Use a custom stamp image**.
6. Press **Select object**, and then select an object on the page.

7. Write or draw digital ink on the page.



**TIP**

- To resume using the default line type, select **Use the default pattern**.
- If you want to save your custom Creative pen style for future use, press **Save Tool Properties**. You can later reset the Creative pen style (see *Customizing the toolbar* on page 189).

## Adding links to objects

You can link any object on a page to a web page, another page in the file, a file on your computer or an attachment. An attachment is a copy of a file, a shortcut to a file or a link to a web page that you add to the Attachments tab.



**NOTE**

You can display animated link indicators around all links on a page (see *Displaying links* on page 138).

### To add a link to a web page

1. Select the object.
2. Press the object's menu arrow, and then select **Link**.  
The *Insert Link* dialog box appears.
3. Press **Web Page**, and then type the web address in the *Address* box.
4. If you want to open the link by pressing an icon, select **Corner icon**.

OR

If you want to open the link by pressing anywhere in the object, select **Object**.

5. Press **OK**.

If you selected **Corner icon**, the  icon appears in the lower-left corner of the object.

### To add a link to another page in the file

1. Select the object.
2. Press the object's menu arrow, and then select **Link**.  
The *Insert Link* dialog box appears.
3. Press **Page in this File**, and then select an option in the *Select a page* area.

4. If you want to open the link by pressing an icon, select **Corner icon**.

OR

If you want to open the link by pressing anywhere in the object, select **Object**.

5. Press **OK**.

If you selected **Corner icon**, the  icon appears in the lower-left corner of the object.

### To add a link to a file on your computer

1. Select the object.
2. Press the object's menu arrow, and then select **Link**.

The *Insert Link* dialog box appears.

3. Press **File on this Computer**, and then type the file's location and name in the *File* box.
4. If you want to attach a copy of the file, select **Copy of file**.

OR

If you want to insert a shortcut to the file, select **Shortcut to file**.

5. If you want to open the link by pressing an icon, select **Corner icon**.

OR

If you want to open the link by pressing anywhere in the object, select **Object**.

6. Press **OK**.

If you selected **Corner icon**, the  icon appears in the lower-left corner of the object.

### To add a link to an attachment

1. Select the object.
  2. Press the object's menu arrow, and then select **Link**.
- The *Insert Link* dialog box appears.
3. Press **Current Attachments**, and then select the attachment in the list.
  4. If you want to open the link by pressing an icon, select **Corner icon**.

OR

If you want to open the link by pressing anywhere in the object, select **Object**.

5. Press **OK**.

If you selected **Corner icon**, the  icon appears in the lower-left corner of the object.

### To remove a link

1. Select the object.
2. Press the object's menu arrow, and then select **Link**.

The *Insert Link* dialog box appears.

3. Press **Remove Link**.

## Adding sounds to objects

You can add a sound to any object (except Adobe Flash Player compatible files and widgets) by attaching a sound file or recording a sound using a computer microphone. You can play the sound during the lesson by pressing an icon in the corner of the object or the object itself.

### NOTE

SMART Notebook software supports the MP3 audio format. If you want SMART Notebook software to support other file types, you can install additional encoders (see *Installing encoders for additional formats* on page 91).

### To add a sound file to an object

1. Select the object.
2. Press the object's menu arrow, and then select **Sound**.

The *Insert Sound* dialog box appears.

3. Press **Browse**.

The *Insert File* dialog box appears.

4. Browse to and select the sound file, and then press **Open**.
5. Select **Corner Icon** if you want to play the sound file when you press an icon in the object's lower-left corner.

OR

Select **Object** if you want to play the sound file when you press anywhere on the object.

6. Press **Attach Sound**.

### To add a recorded sound to an object

1. Connect a microphone to your computer and turn it on.
2. Select the object.
3. Press the object's menu arrow, and then select **Sound**.

The *Insert Sound* dialog box appears.

4. Click **Start Recording**.
5. Record the sound using the microphone.



#### **IMPORTANT**

SMART Notebook software stops recording after one minute. Therefore, ensure the sound is no more than one minute long.

6. Click **Stop Recording**.
7. Type a name for the sound in the *Recording name* box.
8. Optionally, click **Preview Recording** to hear the sound before adding it to the object.
9. Select **Corner Icon** if you want to play the sound file when you press an icon in the object's lower-left corner.

OR

Select **Object** if you want to play the sound file when you press anywhere on the object.

10. Press **Attach Recording**.

### To remove a sound from an object

1. Select the object.
2. Press the object's menu arrow, and then select **Sound**.

The *Insert Sound* dialog box appears.

3. Press **Remove Sound**.

## Animating objects

You can animate an object to fly onto a page from the side, spin, fade in, shrink and more. You can set the animation to start when you open a page or when you press the object.

### To animate an object

1. Select the object.
2. If the Properties tab isn't visible, press **Properties** .
3. Press **Object Animation**.
4. Select options in the *Type*, *Direction*, *Speed*, *Occurs* and *Repeats* drop-down lists.

## Locking objects

You can lock an object to prevent its modification, movement or rotation. Alternatively, you can lock an object but limit its movement either vertically or horizontally, or allow more movement and rotation.

You can remove this lock at any time.

### To lock an object

1. Select the object.
2. Press the object's menu arrow, and then select **Lock > Lock in Place**.

You're unable to move, rotate or modify the object until you unlock it.

#### NOTE

If you press a locked object, a lock icon  appears instead of a menu arrow.

### To lock an object but allow its movement

1. Select the object.
2. Press the object's menu arrow, and then select **Lock > Allow Move**.

You can move the object but you're unable to rotate or modify it until you unlock it.

#### NOTE

If you press a locked object, a lock icon  appears instead of a menu arrow.

### To lock an object but allow its movement vertically



1. Select the object.
2. Press the object's menu arrow, and then select **Lock > Allow Vertical Move**.

You can move the object vertically but you're unable to rotate or modify it until you unlock it.



**NOTE**

If you press a locked object, a lock icon  appears instead of a menu arrow.

**To lock an object but allow its movement horizontally**

1. Select the object.
2. Press the object's menu arrow, and then select **Lock > Allow Horizontal Move**.

You can move the object horizontally but you're unable to rotate or modify it until you unlock it.



**NOTE**

If you press a locked object, a lock icon  appears instead of a menu arrow.

**To lock an object but allow its movement and rotation**

1. Select the object.
2. Press the object's menu arrow, and then select **Lock > Allow Move and Rotate**.

You can move and rotate the object but you're unable to modify it until you unlock it.



**NOTE**

If you press a locked object, a lock icon  appears instead of a menu arrow.

**To unlock an object**

1. Select the object.
2. Press the object's lock icon , and then select **Unlock**.

## Using advanced page features

You can use the following advanced page features when creating lesson activities:

- Student page borders
- Page recording

- Page backgrounds and themes

## Displaying student page borders

If your students use SMART Notebook SE (Student Edition) software to answer questions and take assessments, you might find it helpful when you create question pages to display a student page border showing the page area that will be visible on your students' computer screens.

### NOTE

This procedure applies only if you're using SMART Response software in CE mode.

### To display a student page border

1. Select **View > Alignment**.

The *Alignment* dialog box appears.

2. Press **Student Page Border**.
3. Select the **Show a border around the area that will be visible in SMART Notebook SE during an assessment** check box.
4. Select **Preset value**, and then select a screen resolution from the drop-down list.

OR

Select **Custom value**, and then type the width and height of your students' screens in the boxes.

5. Press **OK**.

A colored border appears on the page around the area your students will be able to view on their computer screens.

## Recording pages with the Lesson Recorder



You can use the Lesson Recorder add-on to record your activities on a page. You can then play the recording on the same page by using the Lesson Recorder or the new playback widget.

### NOTE

SMART Recorder is a different but similar tool. Using SMART Recorder, you can record your actions in programs other than SMART Notebook software. With SMART Recorder, you can record a full screen, specified window or rectangular portion of the screen. If you connect a microphone to your computer, you can also record audio.

For more information, see *Using SMART Recorder* on page 162.

### To record a page







1. Press **Add-ons** , and then press **Lesson Recorder**.
2. Press  **New Recording**.  
A red square appears around the perimeter of the recorded page.
3. Perform the actions that you want to record on the current page.
4. Press  **Stop Recording** when you finish performing these actions.



#### TIPS

- To save your recording, simply save the .notebook file.
- Close the Lesson Recorder add-on during presentations. The playback widget appears at the bottom of the page. You can unlock and move it anywhere on the page.
- You can't remove the recording from the page.

### To play a page recording using the Lesson Recorder add-on

1. Open the page that you recorded.
2. If the Lesson Recorder add-on isn't open, press **Add-ons** , and then press **Lesson Recorder**.
3. Press **Play**  on the playback toolbar.  
You can toggle between **Play**  and **Pause**  while playing the recording.
4. Optionally, you can perform the following actions:
  - Press **Rewind**  to rewind the playback.
  - Press **Fast forward**  to fast forward the playback.

### To play a page recording using the playback widget

1. Open the page that you recorded.
2. If the Lesson Recorder is open, press  on the add-on title bar to close it.

The playback widget appears at the bottom of the page.





#### TIPS

You can unlock and move the widget to anywhere on the page that is easy to access during your presentation.

3. Press **Play**  on the playback widget.

You can toggle between **Play**  and **Pause**  while playing the recording.

4. Optionally, you can perform the following actions:
  - Press **Rewind**  to rewind the playback.
  - Press **Fast forward**  to fast forward the playback.

## Applying page backgrounds and themes

You can define the appearance of pages' backgrounds using the Properties tab or the Gallery.

### Applying backgrounds using the Properties tab



You can set a page's background to a solid color, a gradient of two colors, a pattern or a picture using the Properties tab.

#### To apply a background

1. Select **Format > Page > Set Background Fill**.

The Properties tab displays *Fill Effects* options.

2. Select a fill style:

Fill style	Procedure
None (transparent)	Select <b>No fill</b> .
Solid color	<ol style="list-style-type: none"><li>Select <b>Solid fill</b>.</li><li>Do one of the following:<ul style="list-style-type: none"><li>Select one of the 40 colors in the palette.</li><li>Press <b>More</b>, and then select a color in the dialog box.</li><li>Press the eyedropper , and then select a color on the screen.</li></ul></li></ol>
Gradient of two colors	<ol style="list-style-type: none"><li>Select <b>Gradient fill</b>.</li><li>For each color, do one of the following:<ul style="list-style-type: none"><li>Select one of the 40 colors in the palette.</li><li>Press <b>More</b>, and then select a color in the dialog box.</li><li>Press the eyedropper , and then select a color on the screen.</li></ul></li><li>Select an option in the <i>Style</i> drop-down list.</li></ol>
Pattern	<ol style="list-style-type: none"><li>Select <b>Pattern fill</b>.</li><li>Select a pattern.</li><li>Press <b>Foreground color</b>, select a color in the dialog box, and then press <b>OK</b>.</li><li>Press <b>Background color</b>, select a color in the dialog box, and then press <b>OK</b>.</li></ol>
Picture	<ol style="list-style-type: none"><li>Select <b>Image fill</b>.</li><li>Press <b>Browse</b>. The <i>Insert Image File</i> dialog box appears.</li><li>Browse to and select the picture you want to use as a background, and then press <b>Open</b>.</li></ol>

 **NOTE**

If you insert a large picture, a dialog box may appear and prompt you to either reduce the picture's file size or retain the picture's file size. For more information, see *Setting image optimization preferences* on page 193.

### ■ To remove a background

1. Select **Format > Page > Set Background Fill**.

The Properties tab displays *Fill Effects* options.

2. Select **No fill**.

### Applying backgrounds and themes using the Gallery

You can set a page, all the pages in a group or all the pages in a file using a background or theme from the Gallery.

### ■ To apply a background or theme

1. If the Gallery isn't visible, press **Gallery** .
2. Select **My Content** in the Gallery's category list to view your own backgrounds and themes (see *Creating themes* on the next page).

OR

Select **Gallery Essentials** to view backgrounds and themes you installed with the software.

3. Select **Backgrounds and Themes**.

The Gallery displays thumbnails of the available backgrounds and themes.

4. Press the thumbnail of the theme you want to apply.
5. Press the thumbnail's menu arrow, and then select **Insert in Notebook**.

The *Insert Theme* dialog box appears.

6. Select **Insert theme on all pages** to apply the background or theme to all pages in a file.

OR

Select **Insert theme on all pages of current group** to apply the background or theme to all pages in the current group.

OR

Select **Insert theme on current page only** to apply the background or theme to the current page.

7. Press **OK**.

### ■ To remove a background or theme

1. Right-click the page.
2. Select **Remove Theme**.

3. Select **From All Pages** to remove the background or theme from all the pages to which you applied it.

OR

Select **From Page** to remove the background or theme from the selected page only.

## Creating themes

You can use themes to customize pages. You can create a theme and add it to the Gallery so that it's available in a convenient location. You can then apply this theme to a page, all pages in a group or all pages in a file.

The Gallery also includes some themes.

### To create a theme

1. Select **Format > Theme > Create New Theme**.
2. Type a name for the theme in the *Theme name* box.
3. Set the background in the same way that you would for a page (see *Applying page backgrounds and themes* on page 118).
4. Add and modify objects on the theme in the same way that you would on a page (see *Creating basic objects* on page 33).
5. Press **Save**.

The theme appears in the *My Content* category of the Gallery.

### To create a theme based on the current page

1. Select **Format > Theme > Create New Theme From Page**.
2. Type a name for the theme in the *Theme name* box.
3. Press **Save**.

The theme appears in the *My Content* category of the Gallery.

## Creating example lesson activities

This section includes example lesson activities you can create and also explains how to create other types of lesson activities.

## Creating a matching lesson activity

### NOTE



You'll complete the following tasks when creating matching lesson activities:

- Using the Activity Builder
- Adding sounds to objects (see *Adding sounds to objects* on page 112)

The Activity Builder enables you to create matching activities, sorting activities, labeling activities, games and more using your own content.

Using the Activity Builder, you define one object on the page as an activity object. You then define which objects on the page will be accepted and which will be rejected when you drag the objects over the activity object.

### To create a matching lesson activity

1. Create the object you want to use as the activity object and the objects you want to accept or reject when dragged to the activity object.
2. Press **Add-ons** , and then press **Activity Builder**.
3. Select the object you want to use as the activity object, and then press **Edit**.
4. Drag the objects you want to accept to the *Accept these objects* list.  
A green check mark  appears beside objects you select to accept.
5. Drag the objects you want to reject to the *Reject these objects* list.  
A red X  appears beside objects you select to reject.

### NOTES

- To quickly select any remaining objects on the page to accept or reject, press **Add All Remaining** in the appropriate list.
- To remove an object from a list, drag it to the trash can icon .

6. Press **Done**.



### To change a matching lesson activity's settings

1. Press **Add-ons** , and then press **Activity Builder**.
2. Select the activity object, and then press **Edit**.



#### TIP

If you don't know which object on the page is the activity object, click **Identify**. Blue diagonal lines appear for three seconds over any activity objects on the page.

3. Press **Settings**.
4. Select the desired animation for accepted objects in the first **Animation** drop-down list.
5. Optionally, select the **Also play the object's sound** check box to play sounds attached to accepted objects when they're dragged over the activity object (see *Adding sounds to objects* on page 112).
6. Select the desired animation for rejected objects in the first **Animation** drop-down list.
7. Optionally, select the **Also play the object's sound** check box to play sounds attached to rejected objects when they're dragged over the activity object (see *Adding sounds to objects* on page 112).
8. Press **Done**.

### To present a matching lesson activity

1. Drag the objects (or have students drag the objects) to the activity object.
  - If the object is accepted, the accepted object animation plays (fade out by default).
  - If the object is rejected, the rejected object animation plays (bounce back by default).
2. Press **Add-ons** , press **Activity Builder**, and then press **Reset All** when you're done.

### To remove a matching lesson activity

1. Press **Add-ons** , and then press **Activity Builder**.
2. Select the activity object, and then press **Clear Properties**.

## Creating a hide-and-show lesson activity

### NOTE

You'll complete the following tasks when creating hide-and-show lesson activities:

- Moving objects (see *Moving objects* on page 66)
- Locking objects (see *Locking objects* on page 114)
- Resizing objects using the scaling gesture (see *Using the scale gesture* on page 73)

You can hide an object and then reveal it using several techniques:

- Add a Screen Shade to a page. During the presentation, gradually remove the shade to reveal the underlying text and graphics when you're ready to discuss them (see *Using the Screen Shade* on page 141).
- Cover the object with digital ink and then erase the digital ink (see *Writing, drawing and erasing digital ink* on page 34).
- Cover the object with another object and then change the order of the objects in the stack (see *Rearranging stacked objects* on page 69).
- Use the object animation feature (see *Animating objects* on page 114).

Alternatively, you can hide an object behind a locked object and then use the scaling gesture to enlarge and show the hidden object if you're using a SMART interactive product that supports multitouch gestures.

### To create a hide-and-show lesson activity

1. Create or insert the object you want to hide.



2. Create or insert the object you want to lock.



3. Move the object you want to lock so that it covers the object you want to hide.



4. Select the object you want to lock, press its menu arrow, and then select **Locking > Lock in Place**.

5. Use the scaling gesture to enlarge and show the hidden object while keeping the locked object in place (see *Using the scale gesture on page 73*).



## Creating a reveal lesson activity

### NOTE

You'll complete the following tasks when creating reveal lesson activities:

- Creating tables (see *Creating tables on page 48*)
- Resizing cells (see *Resizing tables, columns or rows on page 54*)
- Filling a table's background with a picture (see *Changing a table's properties on page 52*)
- Adding objects to cells (see *Adding objects to tables on page 50*)
- Adding and removing cell shades (see *Using cell shades on page 142*)

You can use tables and cell shades to create a variety of reveal lesson activities. The following are two examples:

- A puzzle-style reveal lesson activity where you reveal parts of a picture until students can guess what the picture is.

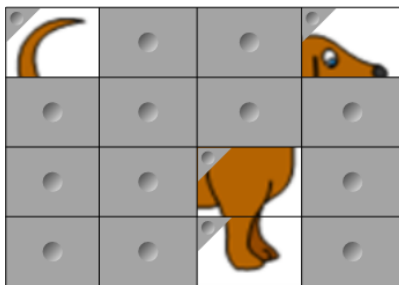

- A memory-style reveal lesson activity where you reveal the contents of the cell and then ask students to choose other cells until they find the cell with matching contents.

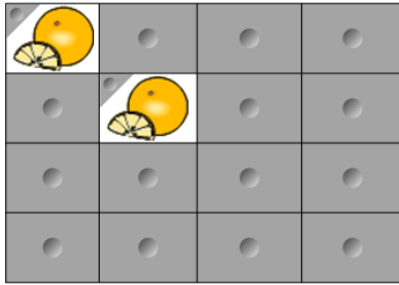

### **To create a puzzle-style reveal lesson activity**

1. Create a table with the number of cells you want to include in the reveal lesson activity (see *Creating tables* on page 48).
2. Resize the cells as appropriate (see *Resizing tables, columns or rows* on page 54).
3. Select the table, press the table's menu arrow, and then select **Properties**.  
The *Properties* tab appears.
4. Press **Fill Effects**.
5. Select **Image fill**, press **Browse**, browse to and select the picture you want to use in the reveal lesson activity, and then press **Open**.
6. Select **Scale image to fit**.
7. Press the table's menu arrow, and then select **Add Table Shade**.

### **To create a memory-style reveal lesson activity**

1. Insert the objects you want to include in the lesson activity.
2. Create a table with the number of cells you want to include in the reveal lesson activity (see *Creating tables* on page 48).
3. Resize the cells as appropriate (see *Resizing tables, columns or rows* on page 54).
4. Drag the objects into the cells of the table.
5. Press the table's menu arrow, and then select **Add Table Shade**.

### **To present a reveal lesson activity**

Press a individual cell's cell shade to reveal the contents of the cell.

To hide the cell behind the cell shade, press  in the corner of the cell.

## Creating other types of lesson activities

The Lesson Activity Toolkit and Lesson Activity Examples in the Gallery include interactive objects you can use to create lesson activities. For more information on the Lesson Activity Toolkit, the Lesson Activity Examples and the Gallery in general, see *Inserting content from the Gallery* on page 82.

The SMART Exchange website includes thousands of lesson plans, question sets and other content that you can download and then open in SMART Notebook software. For more information on the SMART Exchange website, see *Inserting content from the SMART Exchange website* on page 85.

## Chapter 8

# Presenting lesson activities and facilitating collaboration

Preparing before presenting .....	130
Setting the page display .....	131
Zooming in and out .....	131
Panning pages .....	132
Displaying pages in Full Screen view .....	133
Displaying pages in Transparent Background view .....	135
Displaying pages in Dual Page view .....	137
Displaying links .....	138
Moving windows between screens .....	138
Adjusting the volume .....	139
Using presentation tools while presenting .....	139
Recording pages with the Lesson Recorder .....	139
Using the Screen Shade .....	141
Using cell shades .....	142
Using the Magic Pen .....	143
Selecting the Magic Pen .....	143
Using the Magic Pen to create fading objects .....	143
Using the Magic Pen to open a magnification window .....	144
Using the Magic Pen to open a spotlight window .....	146
Using the Text Pen .....	147
Writing with the Text Pen .....	147
Editing with the Text Pen .....	148
Linking objects to tools .....	150
Using the Standard pen type to create fading objects .....	151
Using SMART Blocks .....	152
SMART Block activities .....	152
Using SMART Recorder .....	153
Starting SMART Recorder .....	154
Adding a watermark to recordings .....	154
Changing a recording's file location .....	156
Changing a recording's video and audio quality .....	158
Changing a recording's video format .....	160

Disabling hardware acceleration .....	161
Hiding SMART Recorder .....	161
Using SMART Recorder .....	162
Recording your actions .....	162
Reducing the screen resolution and display colors .....	165
Sharing a recording .....	166
Using measurement tools .....	167
Using the ruler .....	167
Using the protractor .....	169
Using the Geodreieck protractor .....	171
Using the compass .....	173
Clearing or resetting pages after presenting .....	174
Clearing pages .....	175
Resetting pages .....	176
Enabling two people to use an interactive whiteboard .....	177
Enabling two people to use a SMART Board D600 series interactive whiteboard .....	178
Enabling two people to use a SMART Board 800 series interactive whiteboard .....	178
Selecting tools .....	179

---

After creating lesson activities in SMART Notebook software, you can present the lesson activities to students using your interactive product and the presentation features of the software.

In addition to presenting lesson activities to students, you can facilitate collaboration in your classroom using SMART Notebook software and your interactive product. Specifically, you can enable two people to use your SMART Board D600 series or 800 series interactive whiteboard at the same time.

## Preparing before presenting

When you have completed your .notebook files and are ready to present them to students, save the files on a CD, DVD or USB drive. This enables you to access and display the files by inserting the CD, DVD or USB drive into the computer connected to the interactive product. Alternatively, make the files accessible on your local area network, and then browse to them on the interactive product.

Next, prepare for presenting by doing the following:

- Set the page display
- Display any links in the file



- If you have multiple interactive products in your classroom, move windows to the appropriate screens
- If you're presenting video or sound files, adjust the volume

## Setting the page display

You can zoom in and out using the View Screens button or multitouch gestures (if your interactive product supports multitouch gestures).

In addition, SMART Notebook software includes the following views:

- Full Screen view expands the page area to fill the interactive screen by hiding the title bar, toolbar, taskbar and sidebar.
- Transparent Background view enables you to see the desktop and windows behind the SMART Notebook software window and continue to interact with the open, transparent page.
- Dual Page view displays two pages side-by-side.

### Zooming in and out

You can zoom in and out using the View Screens button or multitouch gestures (if your interactive product supports multitouch gestures).

#### To zoom in or out using the View Screens button

1. Press **View Screens** .
2. Select a magnification level between 50% and 300%.

OR

Select **Entire Page** to make the entire page fit your display.

OR

Select **Page Width** to set the page's width to the same width as your display.

**To zoom in or out using multitouch gestures**

Drag your fingers in opposite directions to zoom in.

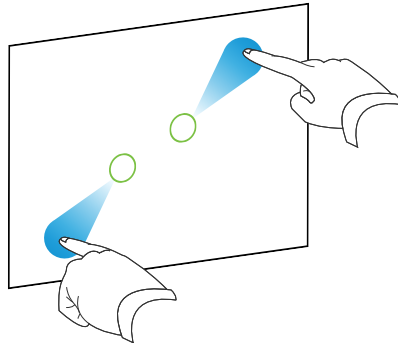

OR

Drag your fingers toward each other to zoom out.

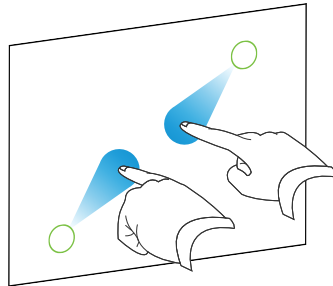

A message appears, displaying the current zoom level.

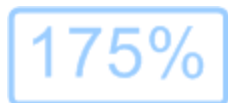

**Panning pages**

If your interactive product supports the pan gesture, you can pan a page when zoomed in (see *Zooming in and out* on the previous page).

### To pan

1. Using two fingers on the same hand, press and hold the screen.
2. Keeping your fingers on the screen, move up, down, left or right.

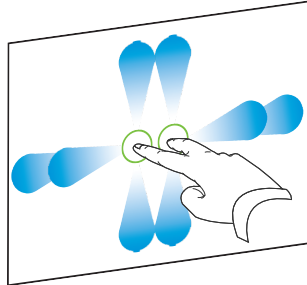

3. When you reach the area you want to view, release your fingers.

### Displaying pages in Full Screen view

In Full Screen view, SMART Notebook software expands the page to fill the screen by hiding the other user interface elements. You can still access commonly used commands using the *Full Screen* toolbar.

#### TIP

Before displaying a page in Full Screen view, select **View > Full Screen Page Border**, and then select the appropriate aspect ratio for your interactive product. A blue line appears, indicating the portion of the page that will appear in Full Screen view without scrolling.







This feature is useful when you're creating content that you want to present in Full Screen view.

**To display a page in Full Screen view**

Press **View Screens** , and then select **Full Screen**.

The page expands to fill the screen, hiding the other user interface elements, and the *Full Screen* toolbar appears.



Button	Command	Action
	Previous Page	Display the previous page in the file.
	Next Page	Display the next page in the file.
...	More Options	Open a menu of options.
	Page Width	Change the zoom level to the page's width.
 <b>TIP</b> This is useful if you're using a widescreen interactive product and gray bars appear on the sides of the page.		
	Entire Page	Change the zoom level to Full Page view.
	Exit Full Screen	Return to the standard view.
	Toolbar Options	Display additional toolbar buttons.





 **NOTES**

- The toolbar displays the current page number and the total number of pages in the file.
- If SMART Response software is installed, additional buttons appear that enable you to insert questions and administer assessments.

### To display more toolbar buttons

Press **Toolbar Options** .

The toolbar expands to include the following buttons:

Button	Command	Action
	Blank Page	Insert a new, blank page in the current file.
	Undo	Reverse the effect of the last action.
	Select	Select objects on the current page.
	Magic Pen	Create objects that slowly fade, open a magnification window or open a spotlight window (see <i>Using the Magic Pen</i> on page 143).

### Displaying pages in Transparent Background view

Using Transparent Background view, you can see the desktop and windows behind the SMART Notebook software window and continue to interact with the open, transparent page. You can draw in digital ink on a transparent page and save your notes in the file. You can also display measurement tools, take screen captures and more. If an area of the screen doesn't include any SMART Notebook software objects, you can select and interact with the desktop and applications behind the SMART Notebook software window.







### To display a page in Transparent Background view

Press **View Screens** , and then select **Transparent Background**.

The background of the SMART Notebook software window becomes transparent, enabling you to see the desktop and program behind SMART Notebook software, but any objects on the .notebook file page remain visible.

The *Transparent Background* toolbar appears.



Button	Command	Action
	Select	Select objects on the current page or interact with desktop and application objects that aren't covered by a SMART Notebook software object.
	Pens and Highlighters	Write or draw digital ink on the current page.
	Previous Page	Display the previous page in the current file.
	Next Page	Display the next page in the current file.
...	More Options	Open a menu of options that enable you to add a screen shade, select different digital ink, select a Creative pen style, add straight lines, add shapes and more.
	Exit Transparent Background	Return to the standard view.
	Toolbar Options	Display additional toolbar buttons.







#### NOTES





- The toolbar displays the current page number and the total number of pages in the file.
- If SMART Response software is installed, additional buttons appear that enable you to insert questions and administer assessments.

### To display more toolbar buttons

Press **Toolbar Options** .

The toolbar expands to include the following buttons:

Button	Command	Action
	Blank Page	Insert a new, blank page in the current file.
	Undo	Reverse the effect of the last action.
	Delete	Delete all selected objects.
	Clear Page	Erase all digital ink and delete all objects from the page.
	Screen Capture Toolbar	Open the Screen Capture toolbar.

Button	Command	Action
	Insert Ruler	Insert a ruler on the page (see <i>Using the ruler</i> on page 167).
	Insert Protractor	Insert a protractor on the page (see <i>Using the protractor</i> on page 169).
	Insert Geodreieck Protractor	Insert a Geodreieck protractor on the page (see <i>Using the Geodreieck protractor</i> on page 171).
	Insert Compass	Insert a compass on the page (see <i>Using the compass</i> on page 173).

### Displaying pages in Dual Page view

You can display two pages side-by-side. You can draw, make notes, import files and add links on either page in the same way as you would on a single page.

When you're displaying dual pages, you can pin a page to continue displaying it in the page area while you view other pages in the Page Sorter.

#### To display a page in Dual Page view

Press **View Screens** , and then select **Dual Page Display**.

A second page appears. A red border indicates the active page.

#### To pin a page

1. If you haven't done so already, display dual pages.
2. Select the page you want to continue displaying.
3. Select **View > Dual Page Display > Pin Page**.

Pin icons  appear in the top corners of the pinned page.

#### To unpin a page

Clear the selection of **View > Dual Page Display > Pin Page**.

#### To return to standard view

Press **View Screens** , and then select **Single Page Display**.

## Displaying links

You can attach a copy of a file, a shortcut to a file, a link to a web page or a sound file to any object on a page (see *Adding links to objects* on page 110). You can display an animated indicator around each object that has a link.

### To display links when a page opens

Select **View > Show All Links When Page Opens**.

Each time you open a page, an animated indicator appears around each object that has a link. Depending on how you define the links, each indicator surrounds either the entire object or an icon in the object's lower-left corner. The indicators disappear automatically after several seconds.



#### NOTE

Clear the selection of **View > Show All Links When Page Opens** to stop displaying links when you open a page.

### To display links on the current page

Select **View > Show All Links**.

An animated indicator appears around each object that has a link. Depending on how you define the links, each indicator surrounds either the entire object or an icon in the object's lower-left corner. The indicators disappear automatically after several seconds.

## Moving windows between screens

You can operate multiple interactive products from the same computer. You can split the computer display over two or more screens, or you can display some programs on one screen and other programs on another. For more information, see *Connecting multiple interactive whiteboards to one computer* ([smarttech.com/kb/000315](http://smarttech.com/kb/000315)).

If you connect multiple interactive products to one computer, you can move windows from one screen to another.

### To move a window from one screen to another

1. If you haven't done so already, display the window.



#### NOTE

You can move a window only if it's neither maximized nor minimized.

2. Press and hold the window on the first screen with your finger.



3. Press the second screen with a finger on your other hand.
4. Lift your finger from the first screen.

The window disappears from the first screen and appears on the second screen.

## Adjusting the volume

If you're presenting a video or sound file and want to adjust volume, you can do so pressing the **Volume Control**  button, and then adjusting your operating system's volume controls.

### NOTE

Ensure your speakers are turned on.

To add this button to the toolbar, see *Customizing the toolbar* on page 189.

## Using presentation tools while presenting

While presenting lesson activities to students, you can use the following tools:

- Screen Shade
- Cell shades
- Magic Pen
- Text Pen (to write editable ink)
- Standard pen type (to create fading objects)
- SMART Blocks
- Measurement tools
  - Ruler
  - Protractor
  - Geodreieck protractor
  - Compass

## Recording pages with the Lesson Recorder



You can use the Lesson Recorder add-on to record your activities on a page. You can then play the recording on the same page by using the Lesson Recorder or the new playback widget.

 **NOTE**

SMART Recorder is a different but similar tool. Using SMART Recorder, you can record your actions in programs other than SMART Notebook software. With SMART Recorder, you can record a full screen, specified window or rectangular portion of the screen. If you connect a microphone to your computer, you can also record audio.

For more information, see *Using SMART Recorder* on page 162.

 **To record a page**

1. Press **Add-ons** , and then press **Lesson Recorder**.
2. Press  **New Recording**.  
A red square appears around the perimeter of the recorded page.
3. Perform the actions that you want to record on the current page.
4. Press  **Stop Recording** when you finish performing these actions.



 **TIPS**

- To save your recording, simply save the .notebook file.
- Close the Lesson Recorder add-on during presentations. The playback widget appears at the bottom of the page. You can unlock and move it anywhere on the page.
- You can't remove the recording from the page.

 **To play a page recording using the Lesson Recorder add-on**

1. Open the page that you recorded.
2. If the Lesson Recorder add-on isn't open, press **Add-ons** , and then press **Lesson Recorder**.
3. Press **Play**  on the playback toolbar.

You can toggle between **Play**  and **Pause**  while playing the recording.

4. Optionally, you can perform the following actions:
  - Press **Rewind**  to rewind the playback.
  - Press **Fast forward**  to fast forward the playback.

### To play a page recording using the playback widget





1. Open the page that you recorded.
2. If the Lesson Recorder is open, press  on the add-on title bar to close it.

The playback widget appears at the bottom of the page.



#### TIPS

You can unlock and move the widget to anywhere on the page that is easy to access during your presentation.

3. Press **Play**  on the playback widget.  
You can toggle between **Play**  and **Pause**  while playing the recording.
4. Optionally, you can perform the following actions:
  - o Press **Rewind**  to rewind the playback.
  - o Press **Fast forward**  to fast forward the playback.

## Using the Screen Shade

If you want to cover information and reveal it slowly during a presentation, you can add a Screen Shade to a page. You can also change the color of your screen shade to enhance your presentation.

If you add a Screen Shade to a page and save the file, the Screen Shade appears over the page the next time you open the file.

### To add a Screen Shade to a page

1. Press **Show/Hide Screen Shade** .  
A Screen Shade appears over the entire page.
2. Press the screen shade to automatically change it to a different color.

### To reveal part of the page

Drag one of the Screen Shade's resize handles (the small circles at the edges of the Screen Shade).

### To remove the Screen Shade from a page

Press **Show/Hide Screen Shade** .

OR

Press **Close**  in the upper-right corner of the Screen Shade.

## Using cell shades

You can add a cell shade to a table cell. This enables you to reveal the information in the cells during a presentation.

### NOTES

- You must remove the cell shade if you want to change the cell's properties; insert columns or rows; remove columns, rows or cells; or split or merge cells.
- You can also add a screen shade to cover an entire page (see *Using the Screen Shade* on the previous page).

### To add a cell shade

1. Select the cell.
2. Press the cell's menu arrow, and then select **Add Cell Shade**.

### To show and hide the contents of a cell

1. Press the cell shade.  
The cell shade disappears, showing the contents of the cell.
2. Press  in the top-left corner of the cell.  
The cell shade appears, hiding the contents of the cell.

### To remove a cell shade

1. Select the cell.
2. Press the cell's menu arrow, and then select **Remove Cell Shade**.

## Using the Magic Pen

The Magic Pen enables you to do the following:

- Create an object that slowly fades
- Open a magnification window
- Open a spotlight window

### Selecting the Magic Pen

Before you can use the Magic Pen, you must select it.

#### To select the Magic Pen

1. Press **Pens** .

The Pens tool buttons appear.

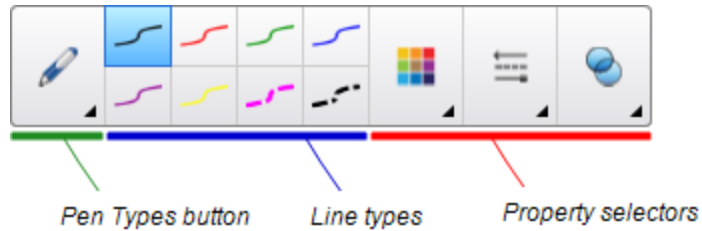

2. Press **Pen Types**, and then select **Magic Pen**.

### Using the Magic Pen to create fading objects

You can create an object that slowly fades using the Magic Pen.

#### NOTE

Fading objects are not saved in .notebook files.

#### To create a fading object

1. Select the Magic Pen (see *Selecting the Magic Pen* above).
2. Using your finger or a pen, write or draw objects on the interactive screen.

The objects slowly fade.

**To set the number of seconds before the object fades**

1. Select the Magic Pen (see *Selecting the Magic Pen* on the previous page).
2. If the Properties tab isn't visible, press **Properties** .
3. Press **Fill Effects**.
4. Enter or select the number of seconds before the object fades in the *Fade time* drop-down list.



**TIP**

You can save your changes to the Magic Pen tool's default settings by clicking **Save Tool Properties** (see *Saving tool settings* on page 65).

**Using the Magic Pen to open a magnification window**

You can open a magnification window using the Magic Pen.

**To open a magnification window**

1. Select the Magic Pen (see *Selecting the Magic Pen* on page 143).
2. Using your finger or a pen, draw a square or rectangle on the interactive screen.

A magnification window appears.

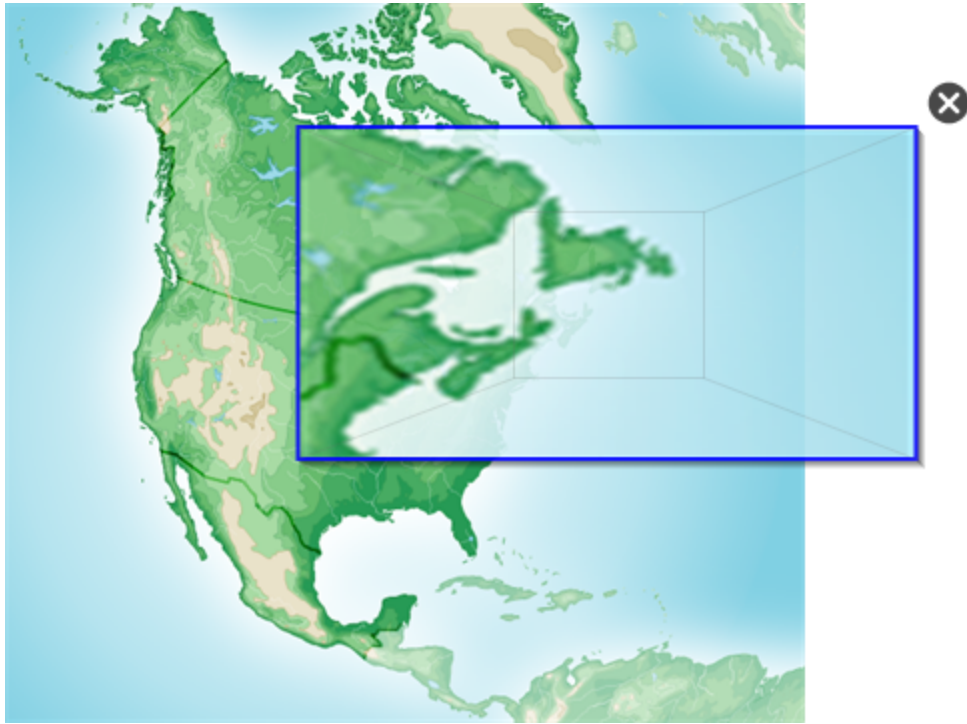

**TIP**

You can draw a square but have it fade rather than open a magnification window by using the Standard pen type (see *Using the Standard pen type to create fading objects* on page 151).

3. Do the following:
  - To reduce the magnification window's size, press in the middle of the window, and then drag to the left.
  - To increase the magnification window's size, press in the middle of the window, and then drag to the right.
  - To move the magnification window, press near the edge of the window, and then drag it.
4. Press **Close**  when you're done.

### Using the Magic Pen to open a spotlight window

You can open a spotlight window using the Magic Pen.

#### To open a spotlight window

1. Select the Magic Pen (see *Selecting the Magic Pen* on page 143).
2. Using your finger or a pen, draw a circle or ellipse on the interactive screen.

A spotlight window appears.

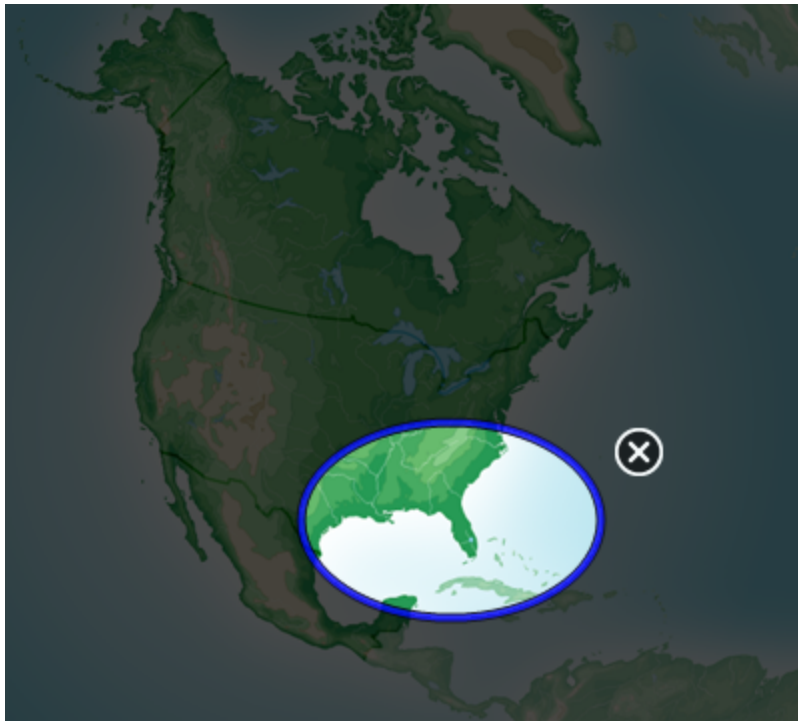

#### TIP

You can draw a circle but have it fade rather than open a magnification window by using the Standard pen tool (see *Using the Standard pen type to create fading objects* on page 151).

3. Do the following:
  - To reduce the spotlight window's size, press in the middle of the window, and then drag to the left.
  - To increase the spotlight window's size, press in the middle of the window, and then drag to the right.
  - To move the spotlight window, press near the edge of the window, and then drag it.
4. Press **Close**  when you're done.



## Using the Text Pen

The Text Pen enables you to do the following:

- Write notes that automatically convert into editable text
- Edit the text as you work without touching a keyboard

### Writing with the Text Pen

You can write notes that automatically convert to editable text using the Text Pen.

#### To write editable text

1. Press **Pens** .

The Pens tool buttons appear.

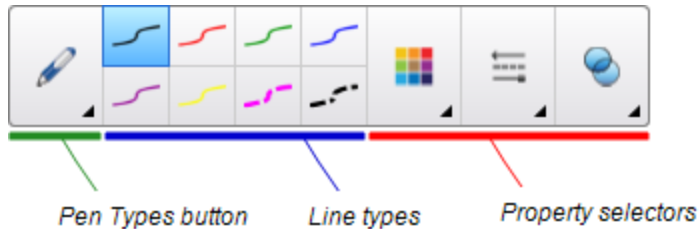

2. Press **Pen Types**, and then select **Text Pen**.
3. Select a line type.



#### TIP

Write tidy, printed characters on a horizontal line. Although SMART Notebook software can convert slanted or cursive writing, it doesn't always do so consistently.

4. Write digital ink notes on the page.

Your handwriting converts to typed text. Accept and reject icons appear beside the typed text.

**SMART**  

5. Press  to accept the typed text.

OR

Press  to restore your handwritten notes.



**TIPS**

- You can perform this action while the Text Pen is active without having to switch to the Select tool .
- The typed text is accepted by default if you don't press one of the icons.

**Editing with the Text Pen**

You can apply mark-ups and make revisions to editable text using the Text Pen. You can delete unwanted text by drawing a strike-through line through the text. You can use different color ink to highlight different parts of your text. You can also apply other mark-ups to insert spaces, to insert text and to replace text with new text.















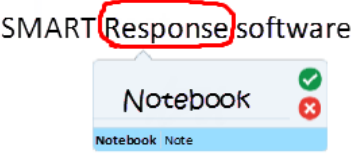

**TIP**

Write your mark-ups in a different color from your editable text. This makes it easier for students to see these edits when you're presenting writing lessons.

Examples of available mark-ups are defined in the following table:

Edit	Instruction	Example
Delete text	Draw a strike-through line through the text.	SMART <del>SMART</del> Notebook
Insert space	Draw a vertical line in the text.	SMART Notebook

Edit	Instruction	Example
Insert text	<ol style="list-style-type: none"> <li>1. Draw a caret ^ symbol where you want to insert text.</li> <li>2. Write the new text in the text box that appears.           <div data-bbox="602 472 1026 646" style="border: 1px solid #ccc; padding: 5px; margin: 10px 0;"> <p> <b>TIP</b></p> <p>Press a line type or press <b>Color</b>  to select a new color for the inserted text.</p> </div> <p>Words that most resemble what you've written display underneath your handwriting.</p> </li> <li>3. Select a word to insert it as typed text. You can also press  to automatically select the word that appears as bold text.</li> </ol> <p>OR</p> <p>Press  to cancel insert text.</p>	
Replace text	<ol style="list-style-type: none"> <li>1. Draw a circle around the text you want to replace.</li> <li>2. Write the replacement text in the box that appears.           <p>Words that most resemble what you've written display underneath your handwriting.</p> </li> <li>3. Select a word to replace the typed text or press  to automatically select the word that appears as bold text.</li> </ol> <p>OR</p> <p>Press  to cancel replace text.</p>	

Edit	Instruction	Example
Change text color	<ol style="list-style-type: none"> <li>1. Press one of the line types or press <b>Color</b>  to select a new color for the typed text.</li> <li>2. Draw a circle around the typed text you want to change.</li> <li>3. Press  to automatically accept the new color selection.</li> </ol> <p>OR</p> <p>Press  to cancel the new color selection.</p>	 <p><b>Sample new text</b></p> 
Change text color of a word with a gesture	<ol style="list-style-type: none"> <li>1. Press one of the line types or press <b>Color</b>  to select a new color for the typed word.</li> <li>2. Draw a horizontal line through the word and return to the start of your line in a back and forth gesture.</li> </ol> <p>The word automatically changes to the new color selection.</p>	<p><b>Sample new text</b></p> 

## Linking objects to tools

Your SMART Notebook software page Toolbar has tools that enable you to create and work with basic objects on pages. If your users find it difficult to reach the toolbar, you can link an object to the Select tool, the Pens tool, or the Eraser tool to create a customized tool that you can place anywhere on your page. Press the object at any time to activate the tool.

### To link an object to a tool

1. Select the object.
2. Press the object's menu arrow, and then select **Link to Tool**.
3. Press one of the tool options.

Your object is linked to the tool.

When you press the linked object, the tool is activated:

- |           |   |
|-----------|---|
| Pen Tool  | <ul style="list-style-type: none"><li>• When you click on the object, the <b>Pens</b> tool is activated</li><li>• You can write content with only the <i>Pen</i> type.</li></ul>  |
| Eraser    | <ul style="list-style-type: none"><li>• When you click on the object, the <b>Eraser</b> tool is activated.</li><li>• You can erase content created by any pen type.</li></ul>   |
| Selection | <ul style="list-style-type: none"><li>• When you click on the object, the <b>Select</b> tool is activated.</li><li>• You can click on another object on the page to open its menu or move it around the page.</li></ul> |

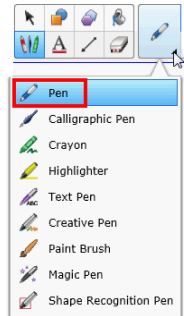

 **TIPS**

- You can draw your own object, use an object from the Gallery, or use a text object.
- You can pre-select the color or line options for your Pen before linking an object to the Pens tool. If you select a new color or line option through the **Pens** tool on the toolbar, the change automatically applies to your linked object.

 **To delete an object's link to a tool**

1. Select the object.
2. Press the object's menu arrow, and then select **Link to Tool**.
3. Press **None**.

## Using the Standard pen type to create fading objects

You can create freehand objects that fade after a specified period of time using the Pens tool.

 **NOTE**

You can also create freehand objects that fade after a specified period of time using the Magic Pen tool (see *Using the Magic Pen to create fading objects* on page 143).

### To write or draw fading digital ink

1. Press **Pens** .

The Pens tool buttons appear.

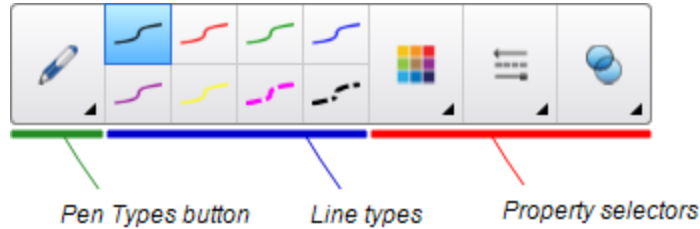

2. Press **Pen Types**, and then select **Pen**.
3. Select a line type.
4. If the Properties tab isn't visible, press **Properties** .
5. Press **Fill Effects**.
6. Select the **Enable ink to fade after you write it** check box, and then enter or select the number of seconds between the time you write or draw the digital ink and the time it fades in the **Fade time** drop-down list.
7. Write or draw digital ink on the page.

### Using SMART Blocks

SMART Blocks is an add-on that enables you to perform math activities with your class by writing numbers on the page, and then connecting them to a SMART Block. You can choose from seven different equation types to work with. You can learn how to use SMART Blocks through the pop-up guide.

### To access SMART Blocks



Press **Add-ons** , and then select **SMART Blocks**.

### To access the SMART Blocks pop-up guide

1. Press **Add-ons** , and then select **SMART Blocks**.
2. Press **Learn More**.

### SMART Block activities

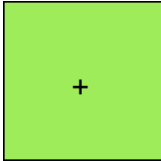
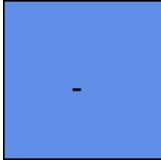
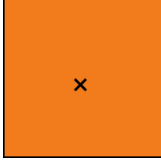
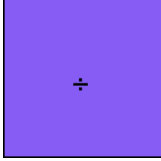
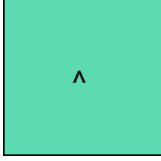
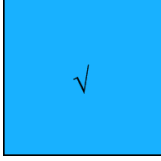
The following SMART Block activities are available:

SMART Block	Function
	Addition blocks accept up to two inputs. The output is the sum of the inputs.
	Subtraction blocks accept up to two inputs. The output is the difference of the inputs.
	Multiplication blocks accept up to two inputs. The output is the product of the inputs.
	Division blocks accept up to two inputs. The output is the quotient of the inputs.
	Power blocks accept up to two inputs. The output is the first input to the power of the second input.
	Square root blocks accept one input. The output is the square root of the input.
	Unknown blocks accept two inputs. The output is a random operation applied to the inputs.

## Using SMART Recorder

Using SMART Recorder, you can record your actions on your interactive product. If you connect a microphone to your computer, you can record your voice as well.

After you create a recording, you can play the recording on any computer using SMART Video

Player or Windows Media® Player, or you can share the recording with others.

#### NOTES

- Windows Media Player is available from [www.windowsmedia.com/download](http://www.windowsmedia.com/download).
- If your computer meets the SMART Notebook software minimum computer requirements, you can use SMART Recorder. However, for best performance, install the software on a computer with a Pentium 4 processor or greater and a sound card and microphone that are compatible with Windows operating systems.

If your computer meets the SMART Meeting Pro software minimum computer requirements, you can use SMART Recorder. However, for best performance, install the software on a computer with a Pentium 4 processor or greater and a sound card and microphone that are compatible with Windows operating systems.

### Starting SMART Recorder

The first step in using SMART Recorder is to start it.

#### To start SMART Recorder

Press the **SMART Board** icon  in the notification area, and then select **Recorder**.

#### NOTE

If your computer isn't currently connected to an interactive product, the **SMART Board** icon includes an X in its lower-right corner .

If your computer isn't currently connected to an interactive product, the **SMART Board** icon is gray and includes an X in its lower-right corner .

In Windows 7 operating system, select **Start > All Programs > SMART Technologies > SMART Tools > Recorder**.

OR

In Windows 8 operating system, go to the *Apps* screen and then scroll to and press **Recorder**.

SMART Recorder appears. A *SMART Recorder* icon  appears in the notification area.

### Adding a watermark to recordings

You can change SMART Recorder settings to add a watermark to a recording's background.



### To add an image watermark to recordings

1. Select **Menu > Options** in SMART Recorder.



#### NOTE

If SMART Recorder is hidden, press the **SMART Recorder** icon  in the notification area, and then select **Configure Options**.

The *Options* dialog box appears.

2. Press the **Watermark** tab.
3. Select **Image**.
4. Press **Browse**.
5. Browse to and select the image you want to use, and then press **Open**.
6. Press **Properties**.

The *Watermark Properties* dialog box appears. A preview of your selected image appears in the *Preview* pane.

7. Do the following:
  - To change the watermark's position, drag the preview image to another area in the *Preview* pane.
  - To change the watermark's size, drag the white circle in the preview image's lower-right corner.
8. Select **Transparency** and **Effect** settings.
9. Press **OK** to close the *Watermark Properties* dialog box.
10. If you want to revert to using no watermark after SMART Recorder closes, select **Turn off the watermark when recorder closes**.
11. Press **OK** to close the *Options* dialog box.

### To add a text watermark to recordings

1. Select **Menu > Options** in SMART Recorder.



#### NOTE

If SMART Recorder is hidden, press the **SMART Recorder** icon  in the notification area, and then select **Configure Options**.

The *Options* dialog box appears.

2. Press the **Watermark** tab.
3. Select **Text**.
4. Type text for the watermark.
5. Press **Properties**.

The *Watermark Properties* dialog box appears. A preview image appears in the *Preview* pane.

6. Select **Color**, **Font** and **Transparency** settings.
7. Do the following:
  - To change the watermark's position, drag the preview image to another area in the *Preview* pane.
  - To change the watermark's size, drag the white circle in the preview image's lower-right corner.
  - To add additional information to the watermark, select **Add Current Date**, **Add Current Time** and/or **Add Frame Number**.
8. Press **OK** to close the *Watermark Properties* dialog box.
9. If you want to revert to using no watermark after SMART Recorder closes, select **Turn off the watermark when recorder closes**.
10. Press **OK** to close the *Options* dialog box.

### To remove a watermark from recordings

1. Select **Menu > Options** in SMART Recorder.



#### NOTE

If SMART Recorder is hidden, press the **SMART Recorder** icon  in the notification area, and then select **Configure Options**.

The *Options* dialog box appears.

2. Press the **Watermark** tab.
3. Select **No Watermark**.
4. Press **OK**.

### Changing a recording's file location

You can change SMART Recorder settings to select a recording's file location.

### To change the folder in which SMART Recorder saves files

1. Select **Menu > Options** in SMART Recorder.



#### NOTE

If SMART Recorder is hidden, press the **SMART Recorder** icon  in the notification area, and then select **Configure Options**.

The *Options* dialog box appears.

2. Press the **Target Files** tab.
3. Press the **Browse** button next to the *Default Save Directory* box.
4. Browse to and select the folder in which you want to save the files, and then press **OK**.



#### TIP

For best performance, save the files on your computer's hard disk rather than a network drive.

5. Press **OK**.

### To change the folder in which SMART Recorder saves temporary files

1. Select **Menu > Options** in SMART Recorder.



#### NOTE

If SMART Recorder is hidden, press the **SMART Recorder** icon  in the notification area, and then select **Configure Options**.

The *Options* dialog box appears.

2. Press the **Target Files** tab.
3. Press the **Browse** button next to the *Temporary Files Directory* box.
4. Browse to and select the folder in which you want to save the temporary files, and then press **OK**.



#### TIP

For best performance, save files and temporary files on the same drive to reduce the time needed to save a recording.

5. Press **OK**.

### To specify disk space limits

1. Select **Menu > Options** in SMART Recorder.



#### NOTE

If SMART Recorder is hidden, press the **SMART Recorder** icon  in the notification area, and then select **Configure Options**.

The *Options* dialog box appears.

2. Press the **Target Files** tab.
3. Select the **Warn me if free disk space is below** check box, and then type a disk space limit to display a message when available disk space is low.
4. Type a disk space limit below which SMART Recorder will stop recording.
5. Press **OK**.

### To restore the default file location of recordings

1. Select **Menu > Options** in SMART Recorder.



#### NOTE

If SMART Recorder is hidden, press the **SMART Recorder** icon  in the notification area, and then select **Configure Options**.

The *Options* dialog box appears.

2. Press the **Target Files** tab.
3. Press **Restore Defaults**.
4. Press **OK**.

### Changing a recording's video and audio quality

You can change SMART Recorder settings to control a recording's audio and video quality.

### To change a recording's video and audio quality

1. Select **Menu > Options** in SMART Recorder.



#### NOTE

If SMART Recorder is hidden, press the **SMART Recorder** icon  in the notification area, and then select **Configure Options**.

The *Options* dialog box appears.

2. Select a sound quality in the *Sound Quality* list.



#### NOTE

Although higher sound quality produces better audio playback, it also increases the file size.

3. Select a video quality in the *Video Quality* list.

OR

Select **Custom**, and then type the required frame rate.



#### NOTE

Although a higher frame rate produces higher quality recordings, it also increases the file size.



#### TIP

If you select **Automatic Selection (Recommended)**, SMART Recorder automatically evaluates your computer and selects the optimal frame rate.

4. Press **OK**.

### To restore a recording's default video and audio quality

1. Select **Menu > Options** in SMART Recorder.



#### NOTE

If SMART Recorder is hidden, press the **SMART Recorder** icon  in the notification area, and then select **Configure Options**.

The *Options* dialog box appears.

2. Press **Restore Defaults**.
3. Press **OK**.

### Changing a recording's video format

You can change SMART Recorder settings to select a recording's video format.

#### To change a recording's video format

1. Select **Menu > Options** in SMART Recorder.



#### NOTE

If SMART Recorder is hidden, press the **SMART Recorder** icon  in the notification area, and then select **Configure Options**.

The *Options* dialog box appears.

2. Press the **Video Format** tab.
3. Select **Windows Media Video (\*.wmv)** or **SMART Recorder Video (\*.avi)**.



#### NOTES

- Any version of Windows Media Player can play a Windows Media video file. Windows Media Player can also play a SMART Recorder video file if SMART Notebook software is installed on the computer playing the file.

Any version of Windows Media Player can play a Windows Media video file. Windows Media Player can also play a SMART Recorder video file if SMART Meeting Pro software is installed on the computer playing the file.

- You can convert a SMART Recorder video file to a Windows Media video file by sharing the recording (see *Sharing a recording* on page 166).

4. Press **OK**.

#### To restore a recording's default video format

1. Select **Menu > Options** in SMART Recorder.



#### NOTE

If SMART Recorder is hidden, press the **SMART Recorder** icon  in the notification area, and then select **Configure Options**.

The *Options* dialog box appears.

2. Press the **Video Format** tab.

3. Press **Restore Defaults**.
4. Press **OK**.

#### Disabling hardware acceleration

SMART Recorder constantly takes screen captures as you record. Some operating systems take screen captures very slowly and this can affect recording quality. To improve recording quality, disable hardware acceleration or upgrade your video driver and video card.



#### IMPORTANT

Disabling hardware acceleration can reduce the performance of SMART Notebook software.



#### NOTE

This procedure may vary depending on your version of Windows operating system and your system preferences.

#### To disable hardware acceleration

1. Open Windows Control Panel.
2. Press **Display**, press **Change display settings**, and then press **Advanced settings**.
3. Press the **Troubleshoot** tab.
4. Drag the **Hardware Acceleration** slider to **None**.
5. Press **OK**.
6. Restart your computer.

#### Hiding SMART Recorder

If you want to, you can hide SMART Recorder but continue to access its menu options using the

SMART Recorder icon



#### To hide SMART Recorder

In SMART Recorder, select **Menu > Hide to System Tray**.

SMART Recorder disappears.

## To show SMART Recorder

Press the **SMART Recorder** icon  in the notification area, and then select **Show**.

SMART Recorder appears.

### Using SMART Recorder

Using SMART Recorder, you can record your actions on your interactive product. If you connect a microphone to your computer, you can record your voice as well.

After you create a recording, you can play the recording on any computer using SMART Video Player or Windows Media® Player, or you can share the recording with others.

### NOTES

- Windows Media Player is available from [www.windowsmedia.com/download](http://www.windowsmedia.com/download).
- If your computer meets the SMART Notebook software minimum computer requirements, you can use SMART Recorder. However, for best performance, install the software on a computer with a Pentium 4 processor or greater and a sound card and microphone that are compatible with Windows operating systems.

If your computer meets the SMART Meeting Pro software minimum computer requirements, you can use SMART Recorder. However, for best performance, install the software on a computer with a Pentium 4 processor or greater and a sound card and microphone that are compatible with Windows operating systems.

### Recording your actions

Using SMART Recorder, you can record the full screen, a specified window or a rectangular portion of the screen. If you connect a microphone to your computer, you can record your voice.

You can create the recording as a SMART Recorder video file that you can view using SMART Video Player, or you can create the recording as a Windows Media video file that you can view using Windows Media Player. If you create the recording as a SMART Recorder video file, you can also convert it to a Windows Media video file or a self-extracting file to share with those who don't have SMART software.

### NOTE

You can also create a Windows Media video file or a self-extracting file of previously created recordings to share with others (see *Sharing a recording* on page 166).



## To create a recording

1. Change SMART Recorder settings to configure the recording's quality, video format, file location and watermark.



### NOTES

- If you have multiple displays, you must select the display that you want to record.
- You can hide SMART Recorder and continue to access its menu options by pressing

the **SMART Recorder** icon  in the notification area.

2. To record the entire screen, press **Record** .



### NOTE

To record the entire screen while SMART Recorder is hidden, press the **SMART Recorder**

icon  in the notification area, and then select **Record**.

OR

To record a screen area, press the down arrow next to the **Record**  button in SMART Recorder, select **Record Area**, and then draw a rectangle around the area you want to record.

OR

To record a window, press the down arrow next to the **Record**  button in SMART Recorder, select **Record Window**, and then select the window you want to record.



### TIP

If you need to reduce the file size of the recording, limit the recording to a rectangular area of the screen or to a window.

3. Perform the on-screen actions you want to record. If you connected a microphone to your computer, speak into your microphone.

SMART Recorder displays the time elapsed during the recording.



### TIP

Animations and other special effects greatly increase the file size of the recording.

4. If you want to pause your recording, press **Pause** . To resume recording, press **Record** .



#### NOTES

- To pause the recording while the *SMART Recorder* window is hidden, press the

**SMART Recorder** icon  in the notification area, and then select **Pause**.

- To resume recording, press the **SMART Recorder** icon in the notification area, and then select **Record**.

5. After you complete the actions you want to record, press **Stop**  in SMART Recorder.



#### NOTE

To stop the recording while SMART Recorder is hidden, press the **SMART Recorder** icon



in the notification area, and then select **Stop**.

The *Save As* dialog box appears.



#### NOTE

If you want to exit without saving your recording, press **Cancel**, press **Yes** to confirm deletion, and then ignore the remaining steps of this procedure.

6. Type a file name.
7. If you want to save the recording in a different location, browse to the new location.
8. Press **Save**.  
  
The *Completing Capture* dialog box appears while SMART Recorder creates the video file.  
  
After SMART Recorder creates the video file, the *Recording Complete* dialog box appears. The information in this dialog box includes the file location of the recording, file size and duration of the recording.
9. If you want to view the recording after you close this dialog box, select **Play Recording**.
10. If you want to share the recording with viewers who don't have SMART Video Player but you created the recording in the SMART Recorder video format, select **Share Recording**.
11. Press **OK**.

If you select **Play Recording**, the file plays in your default media player.

If you select **Share Recording**, the *Share Recording* dialog box appears. Create a Windows Media video file or a self-extracting file as described below.

### To create a Windows Media video file or a self-extracting file

1. Create the recording as described above. Ensure you select the **Share Recording** option.  
The *Share Recording* dialog box appears.
2. Select **WMV** to create a Windows Media video file, and then press **Next**.  
OR  
Select **Self extracting** to create a self extracting file, and then press **Next**.
3. Press **Next**.
4. Press **Browse**, browse to the location where you want to save the file, type a file name, and then press **Save**.
5. Press **Next**.
6. Press **Finish**.

### Enhancing system performance for recording

If your system performance is slow when you use SMART Recorder, or the recording quality isn't the standard you want, the following may improve performance:

- [Reduce your computer's screen resolution and display color settings](#). Smaller screens and fewer colors result in faster performance.
- [Save your files to a local hard disk](#). Network drives are slower and reduce performance.
- [Disable hardware acceleration](#).
- Try a different video card. Some video cards perform better than others. PCI Express cards generally provide a faster performance than Accelerated Graphics Port (AGP) or Peripheral Component Interconnect (PCI) cards.
- [Select a lower video quality setting](#). You need to balance your expectations for video quality with your computer's limitations. Higher video quality produces larger files and places higher demands on your computer.

### Reducing the screen resolution and display colors

If your system performance slows down when you use SMART Recorder, or the recording quality isn't as good as you want, you can reduce your computer's screen resolution and display colors. Smaller screens and fewer colors result in faster performance.

#### NOTE

This procedure may vary depending on your version of Windows operating system and your system preferences.

### To reduce the screen resolution and display colors

1. Open Windows Control Panel.
2. Press **Display**, and then press **Change display settings**.
3. Select a lower setting in the **Resolution** drop-down list.
4. Select a lower setting in the **Colors** drop-down list.



#### NOTE

You're unable to change display colors in Windows 7 and later operating systems.

5. Press **OK**.

### Sharing a recording

If you want to share a recording with viewers who have SMART Notebook software, create a recording as a SMART Recorder video file that they can play using SMART Video Player. If you want to share the recording with viewers who don't have SMART Notebook software, create a Windows Media video file that they can play using Windows Media Player, or create a self-extracting file that they can play on any computer.

If you want to share a recording with viewers who have SMART Meeting Pro software, create a recording as a SMART Recorder video file that they can play using SMART Video Player. If you want to share the recording with viewers who don't have SMART Meeting Pro software, create a Windows Media video file that they can play using Windows Media Player, or create a self-extracting file that they can play on any computer.

### To convert a SMART Recorder video file

1. Select **Menu > Share Recording** in SMART Recorder.



#### NOTE

If SMART Recorder is hidden, press the **SMART Recorder** icon  in the notification area, and then select **Configure Options**.

The *Share Recording* dialog box appears.

2. Select **WMV** to create a Windows Media video file.

OR

Select **Self extracting** to create a self-extracting file, and then press **Next**.

3. Press **Browse**.

4. Browse to and select the SMART Recorder video file you want to convert, and then press **Open**.
5. Press **Next**.
6. If you want to change the converted file's location or name, press **Browse**, browse to the location where you want to save the file, type a file name, and then press **Save**.
7. Press **Next**.
8. Press **Finish**.



## Using measurement tools

Using the SMART Notebook software measurement tools, you can insert a ruler, protractor, Geodreieck protractor or compass into a page.

### Using the ruler

You can insert a ruler into a page, and then manipulate its size, length, rotation and location, and draw along its edges.

#### To insert a ruler

Press **Measurement Tools** , and then select **Insert Ruler** .

A ruler appears.

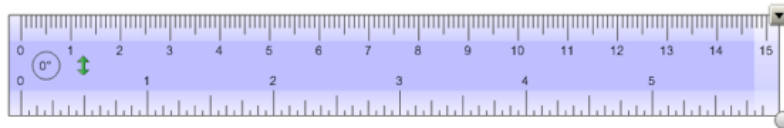

#### To move the ruler

Press the middle of the ruler (displayed as a darker shade of blue), and then drag the ruler to a different position on the page.

#### To resize the ruler

1. Select the ruler.
2. Drag the ruler's resize handle (the circle in the lower-right corner) to increase or reduce the ruler's size.

**To lengthen the ruler (without changing its scale)**

Press the ruler's far edge, between the menu arrow and the resize handle, and then drag away from the ruler.

**To shorten the ruler (without changing its scale)**

Press the ruler's far edge, between the menu arrow and the resize handle, and then drag toward the middle of the ruler.

**To rotate the ruler**

Press the top or bottom edge of the ruler (displayed as a lighter shade of blue), and then drag the ruler in the direction you want to rotate it.

The ruler displays the current rotation in degrees.

**To reverse the measurements**

Press the ruler's flip symbol .

If the metric measurements appeared on the top edge of the ruler, they now appear on the bottom edge and vice versa.

**To draw using a pen and the ruler**

1. Press **Pens** .

The Pens tool buttons appear.

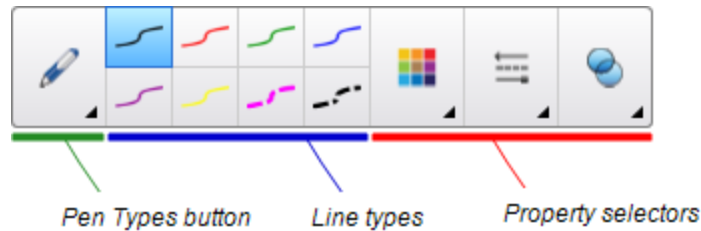

2. Press **Pen Types**, and then select **Pen** or **Calligraphic Pen**.
3. Select a line type.
4. Draw along the edge of the ruler.

Digital ink appears in a straight line along the edge of the ruler.



### To remove the ruler

1. Select the ruler.
2. Press the ruler's menu arrow, and then select **Delete**.

### Using the protractor

You can insert a protractor into a page, manipulate its size, rotation and location, and then draw along its edges.

### To insert a protractor

Press **Measurement Tools** , and then select **Insert Protractor** .

A protractor appears.

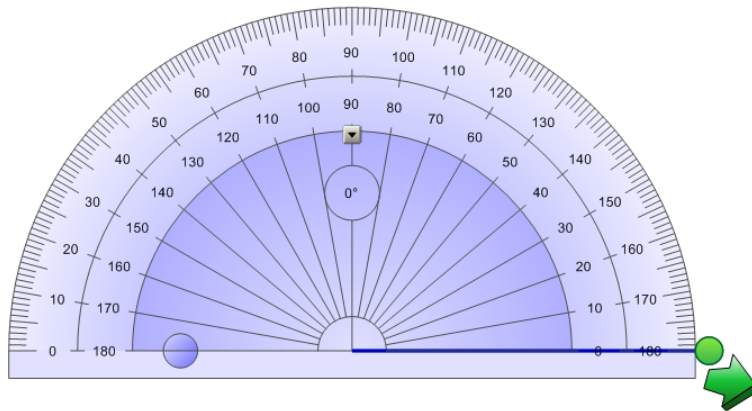

### To move the protractor

Press the inner part of the protractor (displayed as a darker shade of blue), and then drag the protractor to a different position on the page.

### To resize the protractor

Press the inner circle of numbers, and then drag away from the protractor to enlarge it or toward the center of the protractor to shrink it.

### To rotate the protractor

Press the outer circle of numbers, and then drag the protractor in the direction you want to rotate it.

The protractor displays the current rotation in degrees.

**To display the protractor as a complete circle**

1. Press the blue circle  next to the 180 label on the inner circle of numbers.

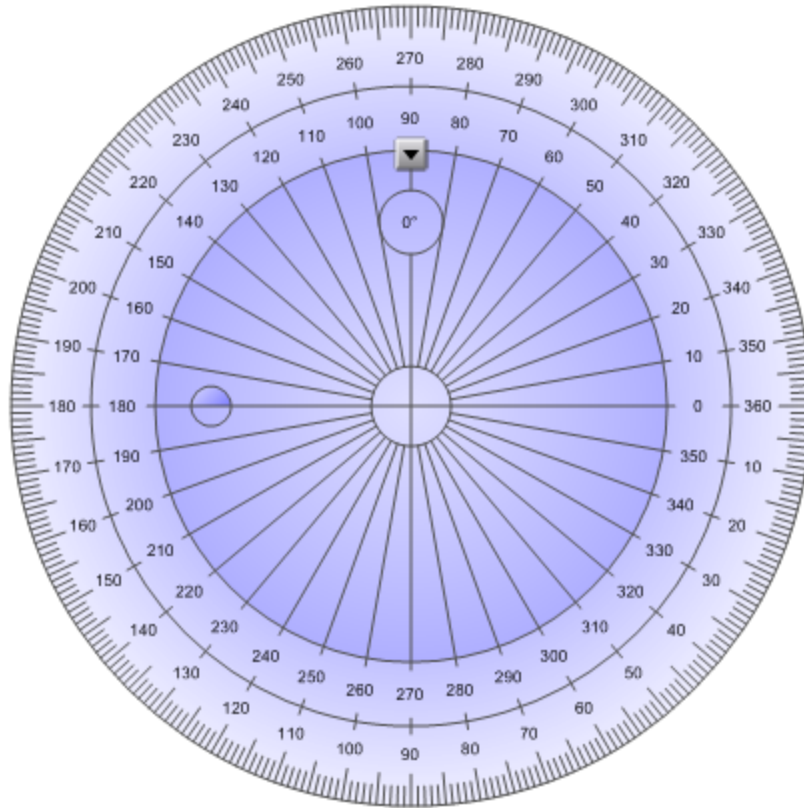

2. Press the blue circle again to return to the semi-circle.

**To draw using a pen and the protractor**

1. Press **Pens** .

The Pens tool buttons appear.

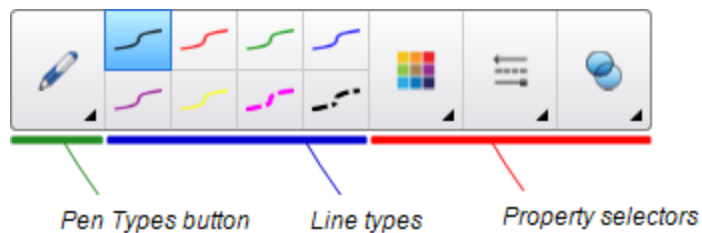

2. Press **Pen Types**, and then select **Pen** or **Calligraphic Pen**.
3. Select a line type.



4. Draw along the edge of the protractor.

Digital ink appears in an arc along the edge of the protractor.

### To display angles using the protractor

1. Select the protractor.
2. Drag the green circle until it shows the correct angle for the first of two intersecting lines.
3. Drag the white circle until it shows the correct angle for the second of two intersecting lines.
4. Press the green arrow in the bottom corner.

The lines and the angle between them appear as a separate object.



### To remove the protractor

1. Select the protractor.
2. Press the protractor's menu arrow, and then select **Delete**.

### Using the Geodreieck protractor

You can insert a Geodreieck protractor (also known as a set square or T-square) on a page, and then manipulate its size, rotation and location.

### To insert a Geodreieck protractor

Press **Measurement Tools** , and then select **Insert Geodreieck** .

A Geodreieck protractor appears.

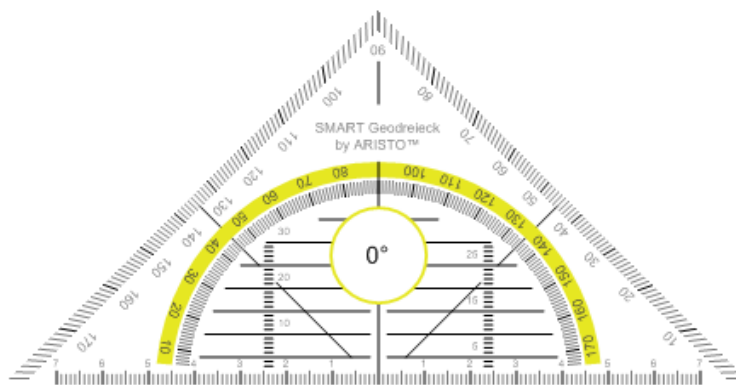

### To move the protractor

Press the inner part of the protractor (within the semi-circle), and then drag the protractor to a different position on the page.

### To resize the protractor

Press the semi-circle, and then drag away from the center of the protractor to make it bigger or toward the center of the protractor to make it smaller.

### To rotate the protractor

Press the outer part of the protractor (outside of the semi-circle), and then drag the protractor in the direction you want to rotate it.

The protractor displays the current rotation in degrees.

### To draw using a pen and the Geodreieck protractor

1. Press **Pens** .

The Pens tool buttons appear.

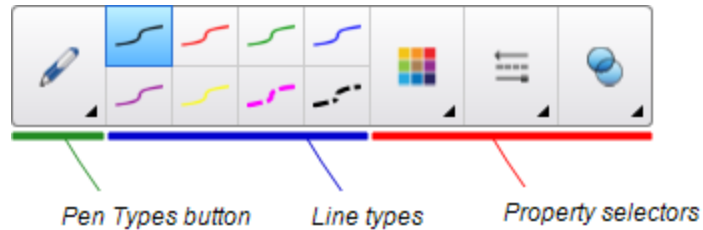

2. Press **Pen Types**, and then select **Pen** or **Calligraphic Pen**.
3. Select a line type.
4. Draw along the edge of the protractor.

Digital ink appears in a straight line along the edge of the protractor.



### To remove the protractor

1. Select the protractor.
2. Press the protractor's menu arrow, and then select **Delete**.

### Using the compass

You can insert a compass into a page, manipulate its width, rotation and location, and then use it to draw circles and arcs.

#### To insert a compass

Press **Measurement Tools** , and then select **Insert Compass** .

A compass appears.

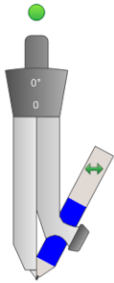

#### To move the compass

Press the arm of the compass that holds the spike, and then drag the compass to a different position on the page.

#### To widen the compass

1. Press the arm of the compass that holds the pen.

Two blue arrows appear.

2. Drag to change the angle between the spike and the pen.

The number on the compass's handle displays the current angle between the spike and the pen.

#### To flip the compass

Press the compass's flip symbol .

The compass's pen appears on the opposite side of the spike.

#### To rotate the compass (without drawing)

Press the compass's rotation handle (the green circle), and then drag the compass in the direction you want to rotate it.

### To draw using the compass

1. Press the compass's pen tip.  
The cursor changes to a pen symbol.
2. Drag the compass in the direction you want to rotate it.

### To change the color of the compass's pen

1. Press **Pens** .

The Pens tool buttons appear.

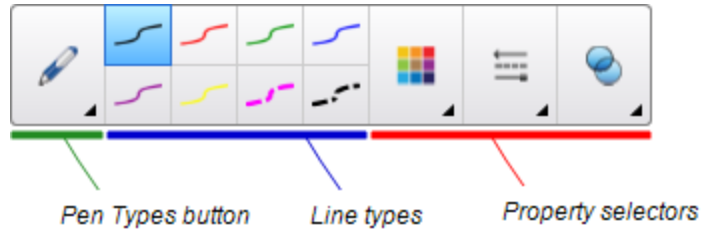

2. Press **Pen Types**, and then select **Pen**.
3. Select a line type.  
The color of the compass's pen changes to display its new color.

### To remove the compass

1. Select the compass.
2. Press the compass's menu arrow, and then select **Delete**.

## Clearing or resetting pages after presenting

After presenting a lesson activity to students, you can clear or reset the pages in your .notebook files to use the files again for future lesson activities.

## Clearing pages

You can erase digital ink and delete individual objects from a page. You can also clear all objects or all digital ink objects from a page simultaneously.

### NOTE

You're unable to clear objects locked in place (see *Locking objects* on page 114) or infinitely cloned objects (see *Cloning objects* on page 72). To clear all objects from a page, you must unlock all locked objects and clear the selection of **Infinite Cloner** on any infinitely cloned objects.

### To clear all objects from the page

1. If you haven't done so already, display the page you want to clear.
2. Select **Edit > Clear Page**.

### NOTES

- This option is disabled if there are no objects on the page or if the objects are locked or infinitely cloned.
- You can also select this option by doing one of the following:
  - Right-clicking the page
  - Pressing the page's menu arrow in the Page Sorter
  - Pressing the page's menu arrow while editing page groups (see *Grouping pages* on page 30)
  - Pressing **Clear Page**  if it's included on the toolbar (see *Customizing the toolbar* on page 189)
- You can clear all objects from multiple pages at the same time. Select the pages' thumbnails in the Page Sorter, press the menu arrow, and then select **Clear Page**.

## To clear all digital ink objects from the page

1. If you haven't done so already, display the page you want to clear.
2. Select **Edit > Clear Ink from Page**.



### NOTES

- This option is disabled if there is no digital ink on the page or if the digital ink is locked or infinitely cloned.
- You can also select this option by doing one of the following:
  - Right-clicking the page
  - Pressing the page's menu arrow in the Page Sorter
  - Pressing the page's menu arrow while editing page groups (see *Grouping pages* on page 30)
  - Pressing **Clear Ink**  if it's included on the toolbar (see *Customizing the toolbar* on page 189)
- You can clear all digital ink objects from multiple pages at the same time. Select the pages' thumbnails in the Page Sorter, press the menu arrow, and then select **Clear Ink from Page**.

## Resetting pages

If you make changes to a page (without saving those changes), you can reset the page to the state it was in before you made the changes.



### NOTE

Resetting a page doesn't reset any Adobe Flash Player compatible files running on the page.

### To reset a page

1. If you haven't done so already, display the page you want to reset.
2. Select **Edit > Reset Page**.

A dialog box appears, prompting you to confirm the reset.



#### NOTES

- This option is disabled if you haven't made changes to the page since last saving the file.
- You can also select this option by doing one of the following:
  - Right-clicking the page
  - Pressing the page's menu arrow in the Page Sorter
  - Pressing the page's menu arrow while editing page groups (see *Grouping pages* on page 30)
  - Pressing **Reset Page**  if it's included on the toolbar (see *Customizing the toolbar* on page 189)
- You can reset multiple pages at the same time. Select the pages' thumbnails in the Page Sorter, press the menu arrow, and then select **Reset Page**.

3. Press **Reset Page**.

## Enabling two people to use an interactive whiteboard

If you have a SMART Board D600 or 800 series interactive whiteboard, two people can create and manipulate objects in SMART Notebook software at the same time. How the two people do this depends on whether you have a SMART Board D600 series interactive whiteboard or a SMART Board 800 series interactive whiteboard.

Allowing two people to use an interactive whiteboard is useful in scenarios such as the following:

- Two students work on an assignment on the interactive whiteboard at the same time
- A teacher and student work on an assignment on the interactive whiteboard at the same time
- A teacher or student poses questions or problems on the interactive whiteboard, and another student responds to these questions or problems

## Enabling two people to use a SMART Board D600 series interactive whiteboard

If you're using a SMART Board D600 series interactive whiteboard, two users can use the interactive whiteboard simultaneously when SMART Notebook software is in Dual-User mode. In Dual-User mode, the screen is divided in half. Each user can press his or her half of the screen with a finger to left-click or drag objects, write using a pen tray pen and erase digital ink using the eraser. Each user can also access frequently used tools using his or her own Floating Tools toolbar.

You can press a toolbar button to switch between Single-User mode and Dual-User mode.

### To display a file in Dual-User mode

Press **View Screens** , and then select **Dual Write Mode**.

### To return to Single-User mode

Press **Exit** .

## Enabling two people to use a SMART Board 800 series interactive whiteboard

If you're using a SMART Board 800 series interactive whiteboard, two people can create and manipulate objects in SMART Notebook software at the same time. Both people can create and manipulate objects in any area of the SMART Notebook software page. Neither user is restricted to a particular section of the page.

Dual-user collaboration mode is enabled when you pick up a pen from the pen tray. One user creates or manipulates objects with his or her finger ("the touch user"). The other user creates or manipulates objects with the pen ("the pen user").

### NOTE

In addition to enabling one touch user and one pen user to use the interactive whiteboard at the same time, you can enable two pen users or two touch users to use the interactive whiteboard at the same time. However, the two users must use the same tool.



### Selecting tools

To change tools or to set properties for touch, the touch user must press the appropriate button on the toolbar or control in the Properties tab with his or finger. The following is an example:



To change tools or to set properties for the pen, the pen user must press the appropriate button on the toolbar or control in the Properties tab with the pen. The following is an example:



#### NOTES

- If the pen user presses a button on the toolbar or sets a property with his or finger instead of the pen, SMART Notebook software changes the selected tool or property for the touch user rather than the pen user.
- When both the touch user and the pen user select multiple objects on the screen, the dashed border of the objects selected by the touch user will be a different color than the dashed border of the object selected by the pen user.



## Chapter 9

# Enhancing SMART Notebook software with add-ons

Installing add-ons .....	181
Using add-ons .....	182
Identifying missing add-ons .....	183
Disabling and removing add-ons .....	183
Accessing XC Collaboration .....	184

---

Add-ons are extensions to SMART Notebook software created by SMART Technologies and by third-party software developers.

SMART Notebook software includes the Activity Builder add-on (see *Creating a matching lesson activity* on page 122) and the Alignment Tools add-on (see *Aligning objects* on page 67). You can install other add-ons from the SMART Exchange website to add specialized features to the software. In addition, you can manage all installed add-ons using the Add-on Manager.

## Installing add-ons

You can search for, browse and install add-ons from the SMART Exchange website.

### To install an add-on

1. Select **Add-ons > Manage Add-ons**.

The Add-on Manager appears.

2. Press **Find More**.

The SMART Exchange website opens in your web browser.

3. If you're new to the SMART Exchange website, press **Join for free**, and then follow the on-screen instructions to create an account.

OR



If you have an account, press **Sign In**, and then follow the on-screen instructions to log on to the SMART Exchange website with your account.

4. Search or browse for an add-on, and then download it to a temporary location on your computer.
5. Double-click the add-on file.
6. Follow the on-screen instructions to install the add-on.

## Using add-ons

After installing an add-on, you can use the features of that add-on like any other features in SMART Notebook software.

### To view an add-on

1. Press **Add-ons**  to open the list of add-ons.
2. Press the add-on's icon to open the add-on.
3. Press  to return to the list of add-ons.

### To view an add-on's version and other information

1. Select **Add-ons > Manage Add-ons** on the software toolbar

OR

Press  on the add-on title bar.

The Add-on Manager appears.

2. Press the add-on's name.
3. Press **About**.

## Identifying missing add-ons

If you open a page in a .notebook file that requires an add-on that isn't installed or is disabled on your computer, a message appears at the top of the page. Press the message to open the Add-on Manager. The Add-on Manager identifies which add-on is required. You can then install that add-on (see *Installing add-ons* on page 181) or enable it (see *Disabling and removing add-ons* below).

## Disabling and removing add-ons

In some situations, you might want to disable or remove a previously installed add-on.

If you choose to disable an add-on, the add-on no longer appears in SMART Notebook software but is still installed on your computer. You can subsequently enable the add-on.

If you choose to remove an add-on, the add-on no longer appears in SMART Notebook software and is removed from your computer.

### To disable an add-on

1. Select **Add-ons > Manage Add-ons**.

The Add-on Manager appears.

2. Press the add-on's name.
3. Press **Disable**.



#### TIP

To enable the add-on again, press **Enable**.

### To remove an add-on

1. Select **Add-ons > Manage Add-ons**.

The Add-on Manager appears.

2. Press the add-on's name.
3. Press **Remove**.



#### NOTE

You're unable to remove the Activity Builder add-on and the Alignment Tools add-on.

## Accessing XC Collaboration

SMART Notebook software includes the basic version of XC Collaboration. The basic version of XC Collaboration is an add-on by FRIELAND that enables students to text ideas from their mobile devices to a SMART Notebook page for the entire class to see. You can also access the online tour to learn how to use XC Collaboration.



### IMPORTANT

Go to [xc-collaboration.com](https://xc-collaboration.com) to purchase a license for the full version of XC Collaboration.

### To access XC Collaboration

1. Press **Add-ons** , and then press **XC Collaboration**.
2. Press **Connect**.

### To access the XC Collaboration online tour

1. Press **Add-ons** , and then press **XC Collaboration**.
2. Press **Start tour**.



### NOTE

You can also access help in the following ways:

- Press  next to the feature you need assistance with.
- Go to [xc-collaboration.com/support](https://xc-collaboration.com/support).

## Chapter 10

# Accessing RSS feeds with SMART Connect

Finding, adding and deleting an RSS feed .....	185
Viewing RSS feed content .....	186
Bookmarking articles .....	187
Inserting images and video in the drawing area .....	188

---

Using the SMART Connect add-on, you can access the latest articles and receive continuously updated headlines from your favorite publications. You can add, delete and manage feeds, view and bookmark articles and insert images and videos from the articles into SMART Notebook software to share with your class.



### To access SMART Connect

Press **Add-ons** , and then press **SMART Connect**.

## Finding, adding and deleting an RSS feed

Many publications and media outlets offer RSS feeds for their content. You can search external websites for the RSS feed URL, and then add that URL to Notebook Connect. You can also delete RSS feeds.

### To add an RSS feed

1. Locate the URL of the RSS feed you want to add.
2. Press **Add-ons** , and then press **SMART Connect**.
3. Press **Settings** , and then press **Add Feed** .

A *Feed URL* box appears.

4. Type the full URL of the RSS feed in the box.

### To delete an RSS feed

Press **Settings** , and then press **Delete Feed**  beside the feed's URL.

## Viewing RSS feed content

After you add an RSS feed, you can access the feed's content and headlines from the main feed. You can mark articles as either read or unread, and you can refresh the main feed to ensure you have access to the latest content.

### To view content from the main feed

1. Press **Main Feed** , and then select a feed from the drop-down menu.

A list of article thumbnails appears.

2. Select the headline on a thumbnail to view more details about the article.
3. Select **View Article** to open the full article.

OR

Select **Back** to return to the list of article thumbnails.



#### NOTE

You can change the default software articles open in (see *To select the default software for opening articles* on the next page).

### To mark an article as read

Press **Main Feed** , and then press  on the article thumbnail.

The icon changes to  and the article appears gray.



### To mark all articles as read

Press **Main Feed** , and then press **Mark all as read**.

The icons change to  on all articles and the articles appear gray.



### ■ To mark an article as unread

Press **Main Feed** , and then press  on the article thumbnail.

The icon changes to  and the article's appearance is restored.

### ■ To refresh the main feed

Press **Main Feed** , and then select .

### ■ To select the default software for opening articles

1. Press **Settings** .
2. Select **Notebook** if you want articles to open in SMART Notebook software.

OR

Select **Your default Web browser** if you want articles to open in your web browser.

## Bookmarking articles



You can bookmark articles to view later by adding them to your favorites list. You can also delete articles from your favorites list.

### ■ To access your favorites list



1. Press **Favorites** .

A list of bookmarked articles appears.

### ■ To add an article to your favorites list

Press **Main Feed** , and then press  in the bottom-right corner of the article thumbnail.





### ■ To delete an article from your favorites list

Press **Favorites** , and then press  in the bottom-right corner of the article thumbnail.

## Inserting images and video in the drawing area

If an article contains an image or a video, you can insert it in the drawing area of SMART Notebook software.

### To insert an image or a video in the drawing area

1. Press **Add-ons** , and then press **Notebook Connect**.
  2. Press **Main Feed** , and then select a feed from the drop-down menu.  
A list of article thumbnails appears.
  3. Press  on an article thumbnail to insert the article's image in the drawing area.
- OR
- Press  on an article thumbnail to insert the article's video in the drawing area.

## Chapter 11

# Maintaining SMART Notebook software

Customizing the toolbar .....	189
Configuring SMART Notebook software .....	191
Changing the default program for .notebook files .....	191
Setting gesture preferences .....	192
Setting image optimization preferences .....	193
Manually reducing the size of large pictures .....	193
Exporting optimized files .....	194
Setting default background color preferences .....	195
Setting measurement tool preferences .....	195
Setting table cell padding preferences .....	197
Setting the language .....	198
Removing SMART software .....	199
Updating and activating SMART software .....	200
Updating SMART software .....	201
Activating SMART software .....	202
Purchasing a product key .....	203
Activating SMART software with a product key .....	203
Sending feedback to SMART .....	205

---

This chapter explains how to maintain SMART Notebook software.

## Customizing the toolbar

The SMART Notebook software toolbar enables you to select and use a variety of commands and tools. You can customize the toolbar so that it includes the tools you use most frequently.

After adding or removing toolbar buttons, you can restore the default set of toolbar buttons. You can also restore the tools' default settings if you customized and saved the settings using the Properties tab (see *Saving tool settings* on page 65).

### To add or remove toolbar buttons

1. Click **Customize the toolbar** .

OR

Right-click the toolbar.

The *Customize Toolbar* dialog box appears.

2. Press **Actions** or **Tools**.

3. Do the following:

- To add a button to the toolbar, press its icon in the dialog box, and then drag it to the toolbar.
- To remove a button from the toolbar, press its icon in the toolbar, and then drag it away from the toolbar.
- To rearrange the buttons, press an icon in the toolbar, and then drag it to a new position in the toolbar.



#### NOTES

- You can only add, remove and rearrange buttons in the panel of the toolbar you selected in step 2. For example, if you pressed **Actions** in step 2, you can only add, remove and rearrange buttons in the *Actions* panel.
- To span a button across rows, drag and hold it between two columns of buttons.



If you're using a smaller screen resolution, only span one or two buttons across rows to prevent issues when the toolbar is wider than the SMART Notebook software window.

4. Press **Done**.

### To restore the default set of toolbar buttons

1. Click **Customize the toolbar** .

OR

Right-click the toolbar.

The *Customize Toolbar* dialog box appears.

2. Press **Restore Default Toolbar**.

### ■ To restore the tools' default settings

1. Click **Customize the toolbar** .

OR

Right-click the toolbar.

The *Customize Toolbar* dialog box appears.

2. Press **Restore Default Tool Properties**.

## Configuring SMART Notebook software

This section explains how to configure SMART Notebook software.

### Changing the default program for .notebook files

If you install a SMART program other than SMART Notebook software that can open .notebook files, you can set that program to be the default for .notebook files. If you want, you can change the default program back to SMART Notebook software later.

### ■ To change the default program when you open a file

1. Open a .notebook file using SMART Notebook software (see *Opening files* on page 15).

A message appears asking whether you want to change the default program for .notebook files to SMART Notebook software.

2. Press **Yes**.

### ■ To change the default program using the Preferences dialog box

1. Select **Edit > Preferences**.

The *SMART Notebook Preferences* dialog box appears.

2. Press **General**.
3. Press **Make Default**.
4. If you want a message to appear when you open a .notebook file and your default program isn't SMART Notebook software, select **Tell me if SMART Notebook software isn't the default program for .notebook files**.
5. Press **OK**.

## Setting gesture preferences

You can interact with objects in SMART Notebook software using gestures, including the shake gesture and the press-and-hold gesture.

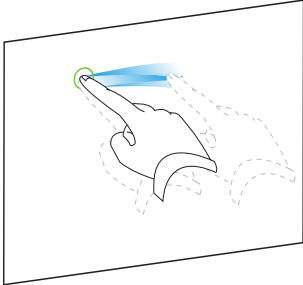
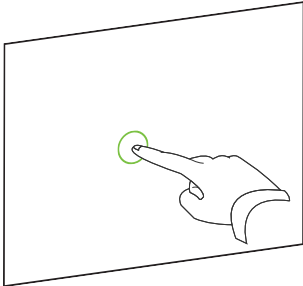
Gesture	Name	Purpose
	Shake gesture	Group two or more objects.
	Press-and-hold gesture	Perform a right-click.

The shake and press-and-hold gestures are enabled by default. However, you can choose to disable them if you find that you or your students frequently invoke the gestures by accident.

### To disable the shake gesture

1. Select **Edit > Preferences**.  
The *SMART Notebook Preferences* dialog box appears.
2. Press **General**.
3. Clear the **Use the shake gesture to group and ungroup objects** check box.
4. Press **OK**.

### ■ To disable the press-and-hold gesture

1. Select **Edit > Preferences**.  
The *SMART Notebook Preferences* dialog box appears.
2. Press **General**.
3. Clear the **Press and hold to perform a right-click** check box.
4. Press **OK**.

## Setting image optimization preferences

If your .notebook files contain large pictures (pictures over 1 MB in file size), your files could open and run slowly. You can reduce the pictures' file size without noticeably reducing their quality. As a result, your .notebook files' overall file sizes will be smaller and the files will open and run more quickly.

### ■ To set image optimization preferences

1. Select **Edit > Preferences**.  
The *SMART Notebook Preferences* dialog box appears.
2. Press **Defaults**.
3. Select one of the following options in the *Image optimization* drop-down list:
  - **Ask every time I insert a large image** to have the option of reducing or not reducing large pictures' file sizes when you insert them.
  - **Never change the resolution of inserted images** to never reduce large pictures' file sizes when you insert them.
  - **Always change image resolution to optimize file size** to always reduce large pictures' file sizes when you insert them.
4. Press **OK**.

### Manually reducing the size of large pictures

If you selected **Ask every time I insert a large image** in the *Image Optimization* drop-down list, you can manually reduce the size of large pictures when you insert those pictures in your file or afterwards.

### ■ To reduce the size of a large picture when inserting it in a file

1. Insert the picture as described in *Inserting pictures* on page 86.  
After you press **Open**, the *Image Optimization* dialog box appears.

2. Press **Optimize** to reduce the picture's file size.

OR

Press **Keep Resolution** to not reduce the picture's file size.



#### NOTES

- When you insert a BMP file, SMART Notebook software internally converts the file to PNG format. This conversion reduces the size of the file. As a result, you might not need to export an optimized version of the .notebook file (see *Exporting optimized files* below) even if the BMP file is over 1 MB in size.
- SMART Notebook software automatically reduces the file size of pictures over 5 MB or 5 megapixels regardless of which option you choose.

### To reduce the size of a large picture after inserting it in a file

1. Select the picture.
2. Press the picture's menu arrow, and then select **Image Optimization**.

The *Image Optimization* dialog box appears.

3. Click **Optimize**.

#### Exporting optimized files

If you have existing files that contain large pictures or if you chose **Never change the resolution of inserted images** in the *Image Optimization* drop-down list, you can export optimized versions of your files that contain reduced pictures. This is particularly useful when you need to present a .notebook file on an older or less powerful computer.

### To export an optimized file

1. Select **File > Export As > Optimized SMART Notebook File**.

The *Export Optimized File* dialog box appears.

2. Browse to where you want to save the new file.
3. Type a name for the file in the *File name* box.
4. Press **Save**.



## Setting default background color preferences

By default, new pages added to your file have a default white background color. You can change the default background color.

### NOTE

This setting only affects new pages, and will be overridden by any applied Themes.

### To change the default background color

1. Select **Edit > Preferences**.

The *SMART Notebook Preferences* dialog box appears.

2. Press **Defaults**.
3. Select **Change Color**, and then select a color.
4. Press **OK**.

## Setting measurement tool preferences

By default, the ruler, protractor and Geodreieck protractor in SMART Notebook software are blue and display best with light-colored backgrounds.

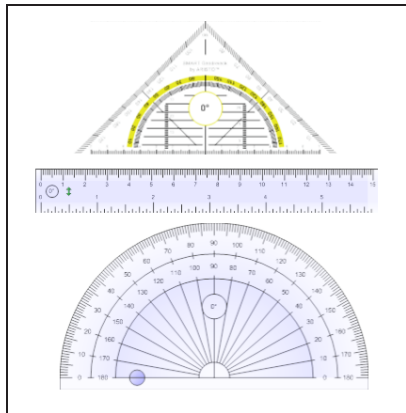

You can change these measurement tools' color to yellow if you want to use them with dark-colored backgrounds.

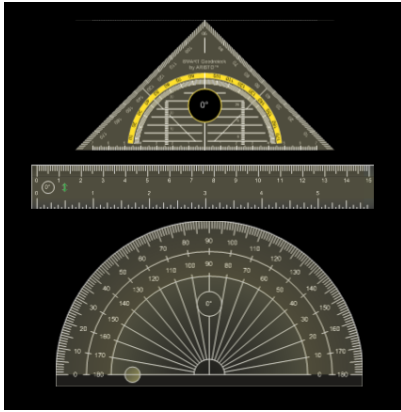

 **NOTE**

Completing the following procedure affects the appearance of measurement tools in .notebook files when viewed on your copy of SMART Notebook software only. If you open the same .notebook files on another copy of SMART Notebook software, the measurement tools could display in a different color.

 **To change the measurement tools' color**

1. Select **Edit > Preferences**.

The *SMART Notebook Preferences* dialog box appears.

2. Press **Defaults**.
3. Select **Blue tint (recommended for light backgrounds)** in the *Measurement tool color* drop-down list to set the measurement tools' color to blue.

OR

Select **Yellow tint (recommended for dark backgrounds)** in the *Measurement tool color* drop-down list to set the measurement tools' color to yellow.

4. Press **OK**.

## Setting table cell padding preferences







SMART Notebook 11 software adds cell padding to tables.

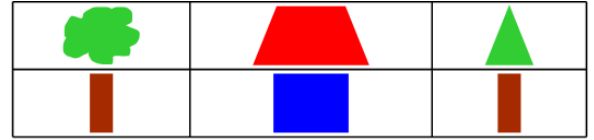

*Table before upgrading to  
SMART Notebook 11 software  
(without cell padding)*



*Table after upgrading to  
SMART Notebook 11 software  
(with cell padding)*

Complete the following procedure to remove cell padding from tables. This is particularly useful if you created tables prior to upgrading to SMART Notebook 11 software and intended the tables' contents to display without cell padding.

### NOTE

Completing the following procedure affects the appearance of tables in .notebook files when viewed on your copy of SMART Notebook software only. If you open the same .notebook files on another copy of SMART Notebook software, the tables display with cell padding (assuming the procedure hasn't been completed on that copy of SMART Notebook software).

### To remove cell padding from tables

1. Select **Edit > Preferences**.  
The *SMART Notebook Preferences* dialog box appears.
2. Press **Defaults**.
3. Clear the **Add cell padding to table cells** check box.
4. Press **OK**.
5. Close and restart SMART Notebook software.

New and existing tables in your .notebook files display without cell padding.

## Setting the language

The SMART Language Setup utility enables you to set the language for a specific SMART application or all SMART applications installed on your computer.

### To set the language

1. Select **Options > Language Setup**.

The *Language Setup* dialog box appears.

2. Select **All Listed Applications** in the first drop-down list to set the language for all applications.



OR

Select an application in the first drop-down list to set the language for only that application.

3. Select the appropriate language in the second drop-down list.



#### NOTES

- If  appears beside your selected language, the language is installed on your computer.
- If  appears beside your selected language, the SMART Language Setup utility downloads the language from the website after you press **OK**.
- By default, the SMART Language Setup utility uses Internet Explorer Internet browser's settings to connect to the Internet. However, you can use different settings by completing the steps under the next procedure.



#### TIP

To display the languages in their native names (for example, *Deutsch* for German), select the **Show native names** check box.

4. If you want to use different languages for handwriting recognition and spell checking, select languages in the *Handwriting recognition* and *Spell check* drop-down lists.



#### NOTE

If *AUTO* appears in the drop-down list, the SMART Language Setup selects your chosen language if available or a similar language if otherwise. If neither option is available, SMART Language Setup selects the current language.

5. If you want to use a different keyboard layout, select a layout in the *Keyboard input language* drop-down list.



#### IMPORTANT

The *Keyboard input language* drop-down list is available only if there's more than one keyboard layout installed on your computer.

The keyboard layout you select in the *Keyboard input language* drop-down list applies to both the on-screen keyboard and the keyboard connected to your computer when you use SMART software.

In some situations, you might want to select a layout that is different from the layout of the keyboard connected to your computer (for example, to teach a second language). In these situations, the on-screen keyboard works correctly, but the keyboard connected to your computer might not.

For best results, ensure the layout you select is identical to the layout of the keyboard connected to your computer. For example, if an English (U.S.) keyboard is connected to your computer, select **English (United States)** in this drop-down list.

For information on keyboard layouts, see <http://msdn.microsoft.com/en-us/global/bb964651>.

6. Press **OK**.

### To set the connection options

1. Select **Options > Language Setup**.

The *Language Setup* dialog box appears.

2. Press **Connection Options**.

The *Connection Options* dialog box appears.

3. Select **Use Internet Explorer settings**.

OR

Select **Use other proxy**, and then type the host, user name and password in the appropriate boxes.

4. Press **OK**.

## Removing SMART software

SMART Support might ask you to remove existing versions of SMART software before you install new versions. You can do this using the SMART Uninstaller.

## To remove SMART software

1. In Windows XP and Windows 7 operating systems, select **Start > All Programs > SMART Technologies > SMART Tools > SMART Uninstaller**.

OR

In Windows 8 operating system, go to the *Apps* screen and then scroll to and press **SMART Uninstaller**.

2. Press **Next**.
3. Select the check boxes of the SMART software and supporting packages that you want to remove, and then press **Next**.



### NOTES

- Some SMART software is dependent on other SMART software. For example, if you select the **SMART Notebook** check box, SMART Uninstaller selects the **SMART Response** check box automatically because SMART Response software is dependent on SMART Notebook software.
- SMART Uninstaller automatically removes any supporting packages that are no longer being used. If you choose to remove all SMART software, SMART Uninstaller automatically removes all supporting packages, including itself.



### TIPS

- To select all software and supporting packages, press **Select All**.
- To clear the selection of all software and supporting packages, press **Clear All**.

4. Press **Uninstall**.

SMART Uninstaller removes the selected software and supporting packages.

5. Press **Finish**.

## Updating and activating SMART software

After you install SMART software, you need to activate it. After you activate the software, you need to install updates from SMART.



### IMPORTANT

To update and activate SMART software, you need to be connected to the Internet.

## Updating SMART software

SMART periodically releases updates to its software and firmware products. (Firmware is software installed in hardware products like the SMART Board interactive whiteboard.) You can use SMART Product Update (SPU) to check for and install these updates.

Your system administrator can install SPU in Full mode or Dashboard mode. In Full mode, you can view installed versions and download and install updates as documented in this section. In Dashboard mode, you can only view installed versions.

### To check for updates automatically

1. In Windows XP and Windows 7 operating systems, select **Start > All Programs > SMART Technologies > SMART Tools > SMART Product Update**.

OR

In Windows 8 operating system, go to the *Apps* screen and then scroll to and press **SMART Product Update**.

The *SMART Product Update* window appears.

2. Select the **Check for updates automatically** check box, and then type the number of days (up to 60) between SPU checks.
3. Close the *SMART Product Update* window.

If an update is available the next time SPU checks, the *SMART Product Update* window appears automatically and the *Update* button of the affected product is enabled.

### To check for updates manually

1. In Windows XP and Windows 7 operating systems, select **Start > All Programs > SMART Technologies > SMART Tools > SMART Product Update**.

OR

In Windows 8 operating system, go to the *Apps* screen and then scroll to and press **SMART Product Update**.

The *SMART Product Update* window appears.

2. Press **Check Now**.

If an update is available for a product, its *Update* button is enabled.

3. If an update is available, install it by following the next procedure.

### To install an update

1. Open the *SMART Product Update* window as described in the previous procedures.
2. Press the product's row.

Product details appear. These product details include the installed version's number and the update's number, date and download size (if an update is available).

#### TIP

Press **View release notes** to view a summary of the changes in the update and the computer requirements for the update.

3. Press **Update**.
4. Follow the on-screen instructions to download and install the update.

#### IMPORTANT

To install updates, you must have full administrator access.

### To disable automatic checking for updates

1. In Windows XP and Windows 7 operating systems, select **Start > All Programs > SMART Technologies > SMART Tools > SMART Product Update**.

OR

In Windows 8 operating system, go to the *Apps* screen and then scroll to and press **SMART Product Update**.

The *SMART Product Update* window appears.

2. Clear the **Check for updates automatically** check box.

#### IMPORTANT

SMART recommends that you do not clear this check box.

## Activating SMART software

Typically, you activate SMART software after installing it. However, in some situations, you activate the software later. For example, you could be evaluating the software before deciding to purchase it.

#### NOTES

- As of version 11.1, you don't need to activate SMART Notebook software or SMART Product Drivers. SMART provides you with the right to use this software when you



purchase a SMART interactive product.

- If you want to use SMART Notebook software with a device that isn't a SMART interactive product, you must purchase a product key.

### Purchasing a product key

For some SMART products, you must purchase a product key from your authorized SMART reseller ([smarttech.com/wheretobuy](http://smarttech.com/wheretobuy)).

#### TIP

If you lose your product key, go to [smarttech.com/findproductkey](http://smarttech.com/findproductkey).

### Activating SMART software with a product key

After obtaining a product key, you can activate SMART software.

#### To activate SMART software

1. In Windows XP and Windows 7 operating systems, select **Start > All Programs > SMART Technologies > SMART Tools > SMART Product Update**.

OR

In Windows 8 operating system, go to the *Apps* screen and then scroll to and press **SMART Product Update**.

The *SMART Product Update* window appears.

2. Press **Activate** or **Manage** for the software you want to activate.

The *SMART Software Activation* window appears.



**NOTE**

The value in the *Status* column indicates the status for each product:

Value	Description
<i>Installed</i>	The software is installed.
<i>Activated</i>	The software is installed and activated with a perpetual or maintenance license.
<i>Subscription</i>	The software is installed and activated with a subscription license. The number in parentheses indicates the days remaining in the subscription period.
<i>Expiring</i>	The software is installed but not yet activated. The number in parentheses indicates the days remaining in the evaluation period.
<i>Expired</i>	The software is installed but not yet activated. The evaluation period is over. You're unable to use the software until you activate it.
<i>Unknown</i>	The software's status is unknown.

3. Press **Add**.
4. Follow the on-screen instructions to activate the software using the product key.

**To view product keys**

1. In Windows XP and Windows 7 operating systems, select **Start > All Programs > SMART Technologies > SMART Tools > SMART Product Update**.

OR

In Windows 8 operating system, go to the *Apps* screen and then scroll to and press **SMART Product Update**.

The *SMART Product Update* window appears.

2. Select **Tools > View Product Keys**.

The *Product Keys* dialog box appears.

3. Press **OK** when you're done viewing the product keys.



**NOTE**

Alternatively, you can view the product keys for a single product by pressing the product's name in the *SMART Product Update* window, and then pressing **View product key**.

## Sending feedback to SMART

When you start SMART software for the first time, a dialog box could appear asking whether you want to join the SMART Customer Experience Program. If you choose to join the program, the software sends information to SMART that helps us improve the software for future releases. After starting the software for the first time, you can enable or disable this feature through the *Help* menu.

You can also send feature request e-mails to SMART.

### ■ To enable the Customer Experience Program tracking feature

Select **Help > Customer Experience Program > Feedback tracking ON**.

### ■ To disable the Customer Experience Program tracking feature

Select **Help > Customer Experience Program > Feedback tracking OFF**.

### ■ To send a feature request e-mail

1. Select **Help > Submit Feature Request**.

A new e-mail message appears in your default e-mail program.

2. Type your request in the new e-mail message, and then press **Send**.



## Chapter 12

# Troubleshooting SMART Notebook software



Troubleshooting files .....	207
Troubleshooting the SMART Notebook software window and toolbar .....	207
Troubleshooting digital ink .....	208
Troubleshooting objects .....	209
Troubleshooting gestures .....	211

This chapter explains how to troubleshoot issues with SMART Notebook software.

## Troubleshooting files

Issue	Recommendation
Your file contains large pictures and runs slowly when you open it in SMART Notebook software.	Export an optimized version of the file (see <i>Setting image optimization preferences</i> on page 193).

## Troubleshooting the SMART Notebook software window and toolbar

Issue	Recommendation
When using SMART Notebook software on an interactive product, you or your students can't reach the toolbar.	<p>Press <b>Move toolbar to top/bottom of window</b>  to move the toolbar from the top of the window to the bottom.</p> <p> <b>TIP</b> If you have a height-adjustable wall mount, you can also adjust the height of your interactive whiteboard or display so that students can reach it.</p>



Issue	Recommendation
<p>Toolbar buttons described in this documentation don't appear on the toolbar.</p>	<p>If a down arrow ▼ appears on the right side of the toolbar, press it to display additional toolbar buttons.</p> <p>If your desired button doesn't appear when you click the down arrow ▼, you or another user might have removed the button (see <i>Customizing the toolbar</i> on page 189).</p> <p>Don't span more than a few buttons across rows to prevent the toolbar from being wider than the SMART Notebook software window.</p>
<p>There isn't enough room on your interactive product to display the contents of a page.</p>	<p>Press <b>View Screens</b> , and then select <b>Full Screen</b> to display the page in Full Screen mode.</p> <p>OR</p> <p>Select the <b>Auto-hide</b> check box to hide the tabs when not in use.</p>
<p>The Page Sorter, Gallery, Attachments, Properties and other tabs disappear whenever you press outside of the tabs.</p>	<p>Press one of the tab's icons to display it, and then clear the <b>Auto-hide</b> check box.</p>
<p>Two users are creating or manipulating objects in SMART Notebook software on a SMART Board 800 series interactive whiteboard. One user is using his or her finger. The other user is using a pen from the pen tray. When the user using the pen presses a button in the toolbar, the selected tool or option changes for the user using his or her finger instead.</p>	<p>The user using the pen must press buttons in the toolbar with the pen, not with his or her finger.</p> <p>For more information, see <i>Enabling two people to use a SMART Board 800 series interactive whiteboard</i> on page 178.</p>





## Troubleshooting digital ink

Issue	Recommendation
<p>SMART Notebook software doesn't recognize handwriting in your language.</p>	<p>Install the appropriate language pack (see <i>Setting the language</i> on page 198).</p>
<p>You want your handwriting to appear more smooth and natural in SMART Notebook software.</p>	<p>Use the Calligraphic pen type rather than the Standard pen type (see <i>Writing or drawing digital ink</i> on page 34).</p>

Issue	Recommendation
You're having trouble writing smoothly in SMART Notebook software on Windows 7 operating system.	The Single Finger Panning feature is turned on. Turn it off (see <a href="http://smarttech.com/kb/147470">smarttech.com/kb/147470</a> ).
When you write with a pen, SMART Notebook software on Windows 7 operating system interprets your actions as mouse clicks.	The Flicks feature is turned on. Turn it off (see <a href="http://smarttech.com/kb/144274">smarttech.com/kb/144274</a> ).

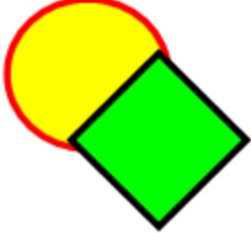
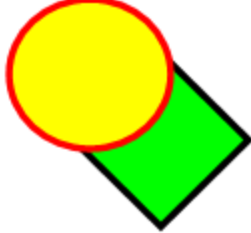
## Troubleshooting objects

Issue	Recommendation
When you create a .notebook file on one computer and then open it on another computer, the objects in the file appear differently.	<p>There are several possible causes. The following are the most common:</p> <ul style="list-style-type: none"> <li>• You used a font that's installed on one computer but not on the other.</li> <li>• The two computers have different operating systems.</li> <li>• The two computers have different versions of SMART Notebook software.</li> </ul>
You want to move, resize or otherwise change an object, but when you do so, you also move, resize or otherwise change other objects.	<p>The objects are grouped. Any changes you make to one object affect the other objects. Select the objects, and then select <b>Format &gt; Group &gt; Ungroup</b> to ungroup them. You can then move, resize or otherwise change the individual objects.</p> <p>For more information, see <i>Grouping objects</i> on page 77.</p>
You want to move, resize or otherwise change an object but can't. A lock icon  appears instead of a menu arrow when you select the object.	<p>The object is locked, which prevents you from making changes to it. To unlock the object, select it, press its lock icon , and then select <b>Unlock</b>.</p> <p>For more information, see <i>Locking objects</i> on page 114.</p>

Issue	Recommendation
<p data-bbox="342 310 786 338">One object on a page covers another:</p>  <p data-bbox="342 632 841 688">You want to change this so that the second object covers the first:</p> 	<p data-bbox="914 310 1464 407">As you create objects, newer objects cover older objects automatically if the objects are in the same position on the page.</p> <p data-bbox="914 422 1456 518">You can change the order of objects. For more information, see <i>Rearranging stacked objects</i> on page 69.</p>
<p data-bbox="342 982 846 1039">When you fill an object with a picture that is larger than the object, the picture is cut off:</p>  <p data-bbox="342 1283 824 1379">Conversely, when you fill an object with a picture that is smaller than the object, the picture is tiled:</p> 	<p data-bbox="914 982 1456 1079">When filling an object with a picture, select <b>Scale image to fit</b> to resize the picture to fit the object:</p>  <p data-bbox="914 1314 1435 1371">For more information, see <i>Changing objects' properties</i> on page 62.</p>



## Troubleshooting gestures

Issue	Recommendation
The multitouch gestures described in this guide aren't working in SMART Notebook software.	Ensure that your interactive product supports multitouch gestures and that multitouch gestures are enabled.



# Index

## A

- activation 202
- Activity Builder 122
- add-ons
  - about 181
  - disabling 183
  - GeoGebra 84
  - identifying missing 183
  - installing 181
  - removing 183
  - SMART Blocks 152
  - SMART Central 185-186, 188
  - SMART Connect 187
  - using 182-183
  - XC Collaboration 184
- Adobe Flash Player compatible files 88
- Adobe Flash video files 90
- AIFF files 91
- animation 114
- arcs 39-40
- arrows 37
- ASF files 91
- attachments 99
- audio encoders 91
- audio files See sound files
- automatic tasks
  - grouping objects 78
  - saving 20
- AVI files 91, 160

## B

- backgrounds 118
- BMP files 17, 23, 86, 194
- bold text 44

## C

- Calligraphic pen type 34
- cell padding 197
- CFF files 19, 95
- check marks 37
- circles 37, 39
- cloning
  - objects 72
  - pages 27
- compasses 173
- content
  - inserting in .notebook files 81
  - organizing 103
  - sharing with other teachers 104
- CPUs 161
- Crayon pen type 34
- Creative pen type 35, 108
- cropping
  - images 70
- crosses 37
- Customer Experience Program 205

## D

- default program for .notebook files 191
- diamonds 37
- digital ink
  - about 34
  - converting to text 42, 147-148
  - erasing 37
  - troubleshooting 208
  - writing or drawing 34
- document cameras 87
- downloads 91
- drop cap 44

## INDEX

Dual-User mode 178

Dual Page view 137

## E

e-mail 24

encoders 91

eraser 37

Essentials for Educators See Gallery

Essentials

exports 17, 104

## F

fading objects 143, 151

feature request e-mails 205

feedback 205

files

attaching to .notebook files 99

attaching to e-mail messages 24

creating 15

cutting, copying, and pasting content  
from 91

displaying in Dual-User mode 178

displaying in Dual Page view 137

displaying in Full Screen view 133

displaying in Transparent Background  
view 135

exporting 17

importing 92-93, 95

linking to objects 111

opening 15

printing 19

reducing size of 193

saving 16

saving automatically 20

troubleshooting 207

Flash files See Adobe Flash Player  
compatible files

Flash video files See Adobe Flash video  
files

footers 18, 20

freehand objects See digital ink

Full Screen view 133

## G

Gallery

adding themes to 121

adding your content to 101

applying backgrounds and themes from 120

exporting content from 104

finding and working with content from 82

importing content to 104

organizing your content in 103

Gallery Essentials 82

Gallery Sampler See Lesson Activity

Examples

Geodreieck protractors 171

GeoGebra

finding and working with content from 84

gestures

about 12

setting preferences for 192

troubleshooting 211

types of

flick 66

panning 132

pinch to zoom 132

rotate 76

scale 73

shake 78, 192

swipe 25

GIF files 17, 23

GPU acceleration 161

for SMART Recorder 161

graphics See pictures

groups

object 77, 209

pages 30

## H

handouts 19

handwriting, conversion to text of 42, 147-148

setting language for 198

## INDEX

headers 18, 20  
heptagons 38  
hexagons 37-38  
highlighter 35  
HTML files 17

## I

images See pictures  
imports 92-95, 104  
Interactive Whiteboard Common File  
    Format 19, 95  
Internet browsers 98  
invisible areas See transparent areas  
italicized text 44

## J

JPEG files 17, 23, 86

## K

keyboards 199

## L

languages 42, 147-148, 198  
Lesson Activity Examples 82  
Lesson Activity Toolkit 82  
lines 40  
links  
    adding to objects 110, 150  
    showing 138  
Linux operating systems 16  
locked objects 114, 209

## M

Mac OS X operating system software 16  
Magic pen tool 35  
Magic Pen tool 143  
magnification 131, 144

math editor 96  
mathematical symbols 46  
measurement tools  
    about 167  
    setting preferences for 195  
    types of  
        compass 173  
        Geodreieck protractor 171  
        protractor 169  
        rulers 167  
MediaCoder 91  
menu arrows 60  
MOV files 91  
MP3 files See sound files  
MPEG files 91  
multimedia files 88  
multiple interactive products 138  
music files See sound files  
My Content category 103, 105, See  
    also Team Content categories

## N

names  
    of files 16, 194  
    of page groups 30  
    of pages 28  
.notebook file format 16, 191  
Notebook software See SMART  
    Notebook

## O

objects  
    adding links to 110, 150  
    adding to tables 50  
    adding to the Gallery 101  
    aligning 67  
    animating 114  
    clearing all from a page 175  
    cloning 72  
    cropping 70  
    cutting, copying and pasting 69

## INDEX

- deleting 79
- erasing 37
- fading 143, 151
- flipping 77
- grouping 77
- locking 114
- moving 66
- moving to other pages 67
- rearranging 69
- resizing 72
- resizing text 45
- rotating 75
- selecting 60
- setting fill and line style for 62
- troubleshooting 209

octagons 38

online resources 85

ovals 39

## P

padding 197

page numbers 18, 20

pages

- adding to the Gallery 102
- clearing 175
- cloning 27
- creating 26
- deleting 31
- displaying 25
- displaying in Dual-User mode 178
- displaying in Dual Page view 137
- displaying in Full Screen view 133
- displaying in Transparent Background view 135
- extending 27
- grouping 30
- hiding with Screen Shades 141
- linking to objects 110
- moving objects between 67
- panning 132
- pinning 137
- printing 19
- rearranging 29
- recording 116, 139
- renaming 28
- setting backgrounds for 118
- zooming in and out 131

Paint Brush pen type 35

panning 132

parallelograms 37

PDF files

- attaching to e-mail messages 24
- exporting 18

pens

- types of
  - Calligraphic 34
  - Crayon 34
  - Creative 35, 108
  - Highlighter 35
  - Magic 35, 143
  - Paint Brush 35
  - Shape Recognition 35, 39
  - Standard 34
  - Text 35

pentagons 37-38

performance, improving

- disabling hardware acceleration 161
- for SMART Recorder
  - disabling hardware acceleration 161
  - reducing screen resolution 165
- reducing screen resolution 165

photographs See pictures

pictures

- about 86
- creating transparent areas in 87
- exporting files to 18
- inserting from a scanner 87
- inserting from a SMART Document
  - Camera 87
- inserting from files 86
- reducing file sizes of 193

PNG files 17, 23, 86

polygons 38

PowerPoint 18, 50, 94

preferences

- gestures 192

## INDEX

- image optimization 193
- measurement tools 195
- table cell padding 197

Preferences

- new page default color 195

printers 19, 92-93

product keys 202

protractors 169

proxy servers 99

## Q

QuickTime files See MOV files

## R

rectangles 37, 39

regular polygons 38

resize handle 73

RSS feed 187

RSS feeds 185-186, 188

rulers 167

## S

scanners 87

screen resolutions 165

Screen Shades 141-142

set squares See Geodreieck protractors

Shape Recognition Pen tool 35, 39

shapes

- about 37
- creating with the Regular Polygons tools 38
- creating with the Shape Recognition Pen tool 39
- creating with the Shapes tool 37

shortcuts 100

Single-User mode 178

SMART Blocks 152

SMART Board 800 series interactive

- whiteboards 178

SMART Board D600 series interactive

- whiteboards 178

SMART Board Tools 3

SMART Document Cameras 87

SMART Exchange 85, 106, 181

SMART Ink

- about 2

SMART Notebook 2

SMART Notebook Document Writer 93

SMART Notebook Print Capture 92

SMART Product Drivers 2

SMART Product Update 201

SMART Recorder

- about 153, 162
- adding watermarks 154
- changing file location 156
- changing video and audio quality 158
- changing video format 160
- hiding 161
- recording 162
- sharing recordings 166
- starting 154

SMART Uninstaller 199

sound files 112, 139

spell checker 46, 198

spotlight 146

squares 37-39

stacks of objects 69

straight lines 40

SWF files See Adobe Flash Player

- compatible files

## T

T-squares See Geodreieck protractors

tables

- about 48
- adding cell shades to 142
- adding columns, rows or cells to 55
- adding objects to 50
- changing properties for 52
- creating 48
- moving 52
- removing 57

## INDEX

- removing cell padding from 197
- removing cell shades from 142
- removing columns, rows or cells from 55
- selecting 51
- splitting or merging cells in 56
- Team Content categories See also My Content category
- text
  - checking spelling of 46
  - converting handwriting to 42, 147-148
  - cutting 47
  - editing 43
  - including mathematical symbols in 46
  - resizing 45
  - typing 42
- Text pen type 35
- themes
  - applying 120
  - creating 121
- thumbnails
  - in printouts 19
  - in the Page Sorter 25
- TIFF files 86
- tool change notifications 11
- toolbars
  - Full Screen 134
  - SMART Notebook 189, 207
  - Transparent Background 135
- transparent areas 87
- Transparent Background view 135
- trapezoids 37
- triangles 37-39
- troubleshooting
  - digital ink 208
  - files 207
  - gestures 211
  - objects 209
  - SMART Notebook software window and toolbar 207

## U

- underlined text 44

- updates 201

## V

- video encoders 91
- videos 90
  - recording 153, 162
- volume 139

## W

- watermarks 154
- WAV files 91
- web browsers See Internet browsers
- web pages 17, 100, 110
- widgets 85
- Windows Media files 91, 160
- Windows operating systems 16
- WMF files 86
- Word 50

## X

- XBK files 15

## Z

- zooming in and out 131, 144





**SMART TECHNOLOGIES**

[smarttech.com/support](https://smarttech.com/support)

[smarttech.com/contactsupport](https://smarttech.com/contactsupport)

[smarttech.com/kb/170657](https://smarttech.com/kb/170657)