

SMART Board® M685ix2

interactive whiteboard system

CONFIGURATION AND USER'S GUIDE

SMART®

FCC warning

This equipment has been tested and found to comply with the limits for a Class A digital device, pursuant to Part 15 of the FCC Rules. These limits are designed to provide reasonable protection against harmful interference when the equipment is operated in a commercial environment. This equipment generates, uses and can radiate radio frequency energy and, if not installed and used in accordance with the manufacturer's instructions, may cause harmful interference to radio communications. Operation of this equipment in a residential area is likely to cause harmful interference in which case the user will be required to correct the interference at his own expense.

Trademark notice

SMART Board, SMART Notebook, DVIT, smarttech, the SMART logo and all SMART taglines are trademarks or registered trademarks of SMART Technologies ULC in the U.S. and/or other countries. Windows and Internet Explorer are either registered trademarks or trademarks of Microsoft Corporation in the U.S. and/or other countries. Apple, iMac, Macintosh, Mac, Mac OS and Mac OS X are trademarks of Apple Inc., registered in the U.S. and other countries. Blu-ray is a trademark of the Blu-ray Disc Association. Crestron, RoomView and RoomView Connected are either trademarks or registered trademarks of Crestron Electronics, Inc. in the United States and/or other countries. Texas Instruments, BrilliantColor and DLP Link are trademarks of Texas Instruments. DLP is a registered trademark of Texas Instruments. All other third-party product and company names may be trademarks of their respective owners.

Copyright notice

© 2013–2015 SMART Technologies ULC. All rights reserved. No part of this publication may be reproduced, transmitted, transcribed, stored in a retrieval system or translated into any language in any form by any means without the prior written consent of SMART Technologies ULC. Information in this manual is subject to change without notice and does not represent a commitment on the part of SMART.

This product and/or use thereof covered by one or more of the following U.S. patents.

www.smarttech.com/patents

01/2015

Important information

Before you install and use your SMART Board interactive whiteboard system, read and understand the safety warnings and precautions in this user's guide and the included important information document. These safety warnings and precautions describe the safe and correct operation of your interactive whiteboard system and its accessories, helping you to prevent injuries and equipment damage. Ensure that your interactive whiteboard system is always being used correctly.

In this document, “interactive whiteboard system” refers to the following:

- SMART Board M685 series interactive whiteboard
- SMART UX80 projector
- Accessories and optional equipment

The projector included with your system is designed to work only with certain SMART Board interactive whiteboard models. Contact your authorized SMART reseller (smarttech.com/where) for more information.

Safety warnings, cautions and important information

Installation



WARNING

- Failure to follow the installation instructions shipped with your SMART product could result in personal injury and damage to the product.
- To reduce the risk of fire or electric shock, do not expose the SMART product to rain or moisture.
- Two people are required to mount your SMART product because it may be too heavy for one person to safely maneuver.

When you lift your interactive whiteboard, you and your assistant should stand on either side of the screen, supporting its weight at the bottom while balancing the top with your other hands.

IMPORTANT INFORMATION

- When mounting the projector boom on a framed or hollow wall, attach the mounting bracket to a stud to safely support the projector's weight. If you use only drywall anchors, the drywall can fail, resulting in possible personal injury, and damage to the product which may not be covered by your warranty.
- Do not leave cables on the floor where they can be a tripping hazard. If you must run a cable over the floor, lay it in a flat, straight line and secure it to the floor with tape or a cable management strip of a contrasting color. Handle cables carefully and avoid excessive bending.

CAUTION

- Do not operate this unit immediately after moving it from a cold location to a warm location. When the unit is exposed to such a change in temperature, moisture can condense on the lens and crucial internal parts. Allow the system to stabilize to room temperature before operation to prevent possible damage to the unit.
- Do not place the unit in hot locations, such as near heating equipment. Doing so could cause a malfunction and shorten the life of the projector.
- Avoid setting up and using the SMART product in an area with excessive levels of dust, humidity and smoke.
- Do not place your SMART product in direct sunlight or near any appliance that generates a strong magnetic field.
- You must connect the USB cable that came with your SMART Board interactive whiteboard to a computer that has a USB compliant interface and that bears the USB logo. In addition, the USB source computer must be compliant with CSA/UL/EN 60950 and bear the CE mark and CSA and/or UL Mark(s) for CSA/UL 60950. This is for operating safety and to avoid damage to the SMART Board interactive whiteboard.

IMPORTANT

- Make sure an electrical socket is near your SMART product and remains easily accessible during use.
- Using your SMART product near a TV or radio could cause interference to the images or sound. If this happens, move the TV or radio away from the projector.

Operation

WARNING

- If you are using an external audio system, use only the power supply included with that product. Using the wrong power supply might create a safety hazard or damage the equipment. If in doubt, refer to the specification sheet for your product to verify the power supply type.
- Do not climb (or allow children to climb) on a wall- or stand-mounted SMART Board interactive whiteboard.

Do not climb on, hang from or suspend objects from the projector boom.

Climbing on the interactive whiteboard or projector boom could result in personal injury or product damage.



CAUTION

- Do not block the projector's ventilation slots and openings.

IMPORTANT

- If you have peripheral devices that do not use a 3.5 mm phone jack audio in/out, a DB15 VGA video input connector or an HDMI™ video connector, or that do not use a 4-pin power mini-DIN output connector to provide power to other SMART products, you may need to purchase third-party adapters.
- Keep your remote control in a safe place because there is no other way to access menu options.
- Disconnect the product from its power source when it's not used for a long period.

Other precautions

If you own a SMART product other than a SMART Board interactive whiteboard system, refer to the installation manual for your product for relevant warnings and maintenance instructions.

Environmental requirements

Before you install your SMART Board interactive whiteboard system, review the following environmental requirements.

Environmental requirement	Parameter
Operating temperature	<ul style="list-style-type: none"> • 41°F to 95°F (5°C to 35°C) from 0' to 6000' (0 m to 1800 m) • 41°F to 86°F (5°C to 30°C) from 6000' to 9800' (1800 m to 3000 m)
Storage temperature	<ul style="list-style-type: none"> • -4°F to 122°F (-20°C to 50°C)
Humidity	<ul style="list-style-type: none"> • 5% to 95% storage relative humidity, non-condensing • 5% to 85% operating relative humidity, non-condensing
Water and fluid resistance	<ul style="list-style-type: none"> • Intended for indoor use only. Doesn't meet any salt-spray or water ingress requirements. • Don't pour or spray liquids directly onto your interactive whiteboard, the projector or any of its sub-components.
Dust	<ul style="list-style-type: none"> • Intended for use in office and classroom environments. Not for industrial use where heavy dust and pollutants can cause malfunctions or impaired operation. Periodic cleaning is required in areas with heavier dust. See <i>Cleaning the projector</i> on page 25 for information on cleaning the SMART UX80 projector.
Electrostatic discharge (ESD)	<ul style="list-style-type: none"> • EN61000-4-2 severity level 4 for direct and indirect ESD • No malfunction or damage up to 8kV (both polarities) with a 330 ohm, 150 pF probe (air discharge) • Unmated connectors meet no malfunction or damage up to 4kV (both polarities) for direct (contact) discharge
Cables	<ul style="list-style-type: none"> • All SMART Board interactive whiteboard system cables should be shielded to prevent potential accidents and degraded video and audio quality.
Conducted and radiated emissions	<ul style="list-style-type: none"> • EN55022/CISPR 22, Class A

Contents

Important information	i
Safety warnings, cautions and important information	i
Environmental requirements	iv
Chapter 1: About your interactive whiteboard system	1
SMART Board M685ix2 interactive whiteboard system features	2
Included accessories	5
Optional accessories	5
Chapter 2: Installing your interactive whiteboard system	7
Choosing a location	7
Choosing a height	8
Routing the cables	9
Installing SMART software	9
Setting up the projector image	9
Integrating your system with peripheral devices	12
Chapter 3: Using your interactive whiteboard system	13
Using your projector	13
Using your interactive whiteboard	22
Chapter 4: Maintaining your interactive whiteboard system	23
Maintaining your interactive whiteboard	23
Cleaning the projector	25
Focusing and adjusting the projector image	25
Removing and replacing the projector lamp module	25
Resetting the lamp hours	27
Replacing the remote control battery	28
Chapter 5: Troubleshooting your interactive whiteboard system	29
Before you start	30
Determining you interactive whiteboard system's status	32
Resolving interactive whiteboard issues	33
Resolving projector issues	34
Resolving audio issues	39
Resolving network communication issues	40
Accessing the service menu	41
Transporting your interactive whiteboard system	42

CONTENTS

Appendix A: Remotely managing your system through a network interface 43
 Web page management 43
 Simple Network Management Protocol (SNMP) 51
 Crestron® RoomView® 51

Appendix B: Remotely managing your system through an RS-232 serial interface 53
 Connecting your room control system to the SMART UX80 projector 54
 Projector programming commands 56

Appendix C: Integrating other devices 77
 Video format 77
 Connecting peripheral sources and outputs 80

Appendix D: Remote control code definitions 83

Appendix E: Hardware environmental compliance 85
 Waste Electrical and Electronic Equipment and Battery regulations (WEEE and
 Battery Directives) 85
 Batteries 85
 Mercury 85
 More information 85

Index 87

Chapter 1

About your interactive whiteboard system

SMART Board M685ix2 interactive whiteboard system features	2
SMART Board M600 series interactive whiteboard	2
SMART UX80 projector	3
Included accessories	5
Remote control	5
Pens	5
Optional accessories	5
Hardware mounting kit	5

Your SMART Board interactive whiteboard system combines the following components:

- SMART Board M600 series interactive whiteboard
- SMART UX80 projector
- Accessories and optional equipment

This chapter describes the features of your interactive whiteboard and provides information about product parts and accessories.

SMART Board M685ix2 interactive whiteboard system features

Your SMART Board M685ix2 interactive whiteboard system uses the WXGA (16:10) ultra-short-throw, high-offset SMART UX80 projector. It delivers high-definition, high performance interactivity that is virtually shadow-free and glare-free.

The modular and expandable hardware and software architecture of your interactive whiteboard system enables you to do everything you can do at your computer—open and close applications, meet with others, create new documents or edit existing ones, visit websites, play and manipulate video clips and more—just by touching the interactive surface.

The projector also supports video and audio connections from a variety of devices, including DVD and Blu-ray™ players, document cameras, and other high-definition sources, and can project media from these sources onto the interactive screen.

When you use SMART software with your SMART Board M685ix2 interactive whiteboard system, you can write over any application in digital ink using a pen tray pen or your finger, and then save these notes for future reference and distribution.

SMART Board M600 series interactive whiteboard

Your SMART Board M600 series interactive whiteboard, featuring SMART's proprietary DVIT® (Digital Vision Touch) technology, is the most intuitive touch-sensitive front projection interactive whiteboard in the world.

The SMART Board M600 series interactive whiteboard performs best with the SMART UX80 projector because of its exceptional color performance, aspect ratio, input response and short-throw image distance.

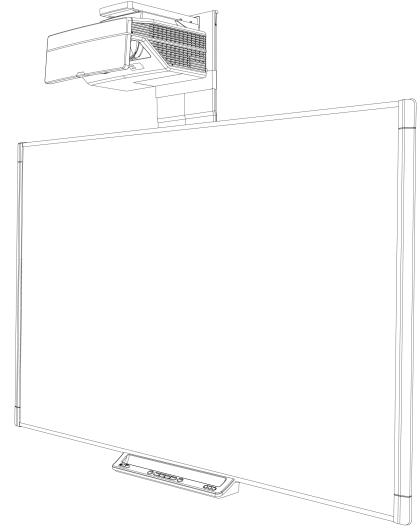

Other features of your interactive whiteboard include the following:

- Pen tray buttons that activate the pens' colors and the on-screen keyboard, as well as right-click and Orientation functions
- A durable hard-coated surface that is optimized for projection and is easily cleaned

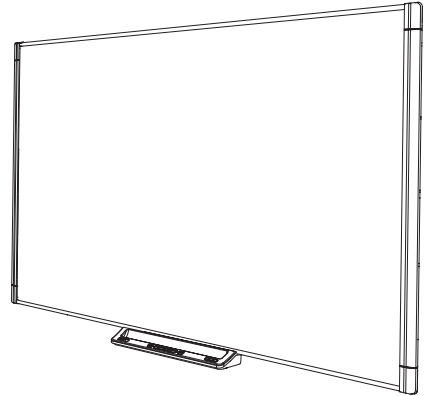

For more information about your SMART Board interactive whiteboard, see the *SMART Board M600 series interactive whiteboard user's guide* (smarttech.com/kb/170410).

 **NOTE**

Because of its wide-screen format, the SMART UX80 projector is compatible only with SMART Board M685 interactive whiteboards, and not with SMART Board M680 interactive whiteboards.

SMART UX80 projector

The SMART UX80 projector system includes an ultra-short-throw projector for use with SMART Board interactive whiteboards and a sturdy support system ideal for corporate and classroom environments.

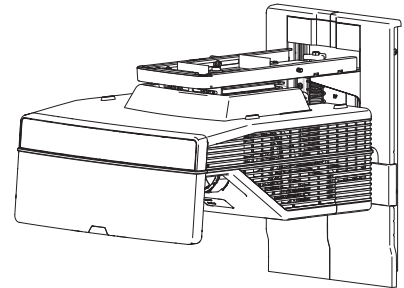

The features of the projector system include the following:

- A wall-mounted, high-offset SMART UX80 projector engine that uses single chip DLP® technology by Texas Instruments™, providing BrilliantColor™ performance, High Contrast, and Gamma 2.1 correction with Bright Classroom, Dark Classroom, sRGB, User and SMART Presentation modes
- 16:10 aspect ratio
- 3600 ANSI lumens (typical)
- PAL, PAL-N, PAL-M, NTSC, NTSC 4.43, SDTV (480i/p and 576i/p), HDTV (1080p) video system compatibility
- Native 1280 × 800 resolution
- Apple Macintosh, iMac and VESA® RGB video format standard compatibility

- Remote management via network through an RJ45 cable

OR

Remote management via a serial RS-232 interface

- Connectivity for a second SMART UX80 projector in a dual interactive whiteboard system
- Self-protection timer for a hot re-strike of the projector lamp
- Protected cable routing through the projector housing and a cable cover that prevent tampering and clutter
- Secure mounting and installation system that includes a projector padlock loop
- An internal speaker
- Templates and instructions for positioning the system safely

Your SMART UX80 projector connection panel has the following connections:

- 3.5 mm phone jack audio input connector
- 3.5 mm phone jack audio output connector
- DB15F (DE-15F) RGB VGA video input connector
- DB9F (DE-9F) RS-232 connector
- HDMI 1 In input connector
- HDMI 2 In input connector
- Power
- USB B connector for service access
- RJ45 (8P8C modular) connector for local area network connections
- RJ45 (8P8C modular) connector for dual interactive whiteboard systems
- 7-pin mini-DIN connector
- 4-pin power-DIN 5V/2A output connector

Included accessories

The following accessories are included with your interactive whiteboard system.

Remote control

The remote control enables you to control the system and set up your projector. Use the remote control to access menu options, system information and input selection options.

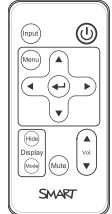

Pens

There are two pens included with your interactive whiteboard. Pick up a pen and press one of the four color buttons on the pen tray (black, red, green or blue) to select the color of digital ink you write on the interactive whiteboard.

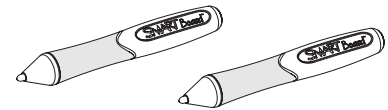

Optional accessories

You can add a variety of accessories to your interactive whiteboard to best meet your specific needs. Purchase these items from your authorized SMART reseller (smarttech.com/where).

For more information on accessories, go to smarttech.com/accessories.

Hardware mounting kit

You can order a hardware mounting kit from your authorized SMART reseller (smarttech.com/where). It contains an assortment of screws and wall anchors for several different wall types (see smarttech.com/kb/160505).

You can also order a hardware mounting kit for your interactive whiteboard (see smarttech.com/kb/170475).

Chapter 2

Installing your interactive whiteboard system

Choosing a location	7
Choosing a height	8
Routing the cables	9
Installing SMART software	9
Setting up the projector image	9
Focusing the image	10
Aligning the image	10
Projector connection diagram	11
Integrating your system with peripheral devices	12



IMPORTANT

This chapter provides additional considerations and details for installing your interactive whiteboard system.

Choosing a location

Choose a location for your interactive whiteboard system that's far from bright light sources, such as windows and strong overhead lighting. IR lighting can cause issues with the performance of the cameras and can lead to unintentional or missed touches.

Select a wall with a flat, regular surface and sufficient clearance to accommodate your interactive whiteboard system. Install the projector and your interactive whiteboard on the same flat surface. For best presentation alignment, mount your interactive whiteboard system in a location that's central to your audience's viewing direction.

For mobile or adjustable installation options, contact your authorized SMART reseller.



WARNING

Refer to your interactive whiteboard system's specifications (available at smarttech.com/support) for its weight. Check your local building codes to ensure that your wall can support this weight, and use appropriate mounting hardware for your wall type.

Choosing a height

SMART includes a mounting template with each interactive whiteboard system. If you lose this template, contact your authorized SMART reseller. Using this template ensures that you can do the following:

- Mount the projector at a safe height for head space clearance, while maintaining enough space for airflow and installation access above the unit.
- Position the projector at the correct height above your interactive whiteboard to align the projected image with the touch screen.

Dimensions on the template recommend a distance from the floor suitable for adults of average height. You should consider the general height of your user community when you choose a location for your interactive whiteboard.

Routing the cables

When connecting cables from the SMART UX80 projector to your interactive whiteboard, make sure that all cables pass between the two interactive whiteboard wall-mounting brackets and that the cables don't rest on the wall-mounting brackets.

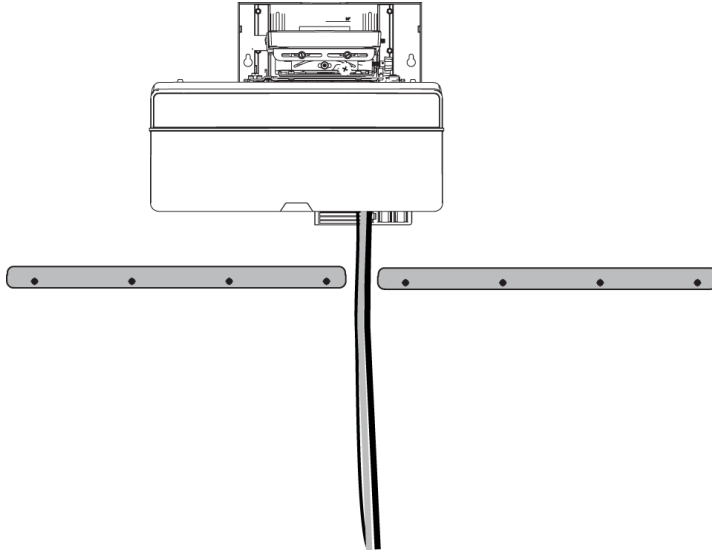

Installing SMART software

You must install SMART software, such as SMART Notebook® collaborative learning software on the computer connected to your interactive whiteboard system to access all of its features.

Download SMART software from smarttech.com/software. These web pages list the minimum hardware requirements for each software version. If SMART software is already installed on your computer, take this opportunity to upgrade your software to ensure compatibility.

Setting up the projector image

You must focus the projected image, and then align the projected image.

Focusing the image

Use the focus lever on the bottom of the SMART UX80 projector to focus the projected image.

To focus and adjust the image

Turn the focus lever clockwise or counterclockwise until the image is in focus.

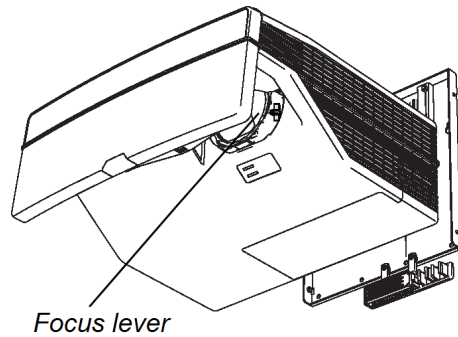

Aligning the image

CAUTION

Never touch the lens or the mirror with your hands or a brush. This can disturb the focus or quality of image that your projector displays.

The projector's image alignment screen appears when you start your projector the first time, or you can access it from the startup screen menu any time.

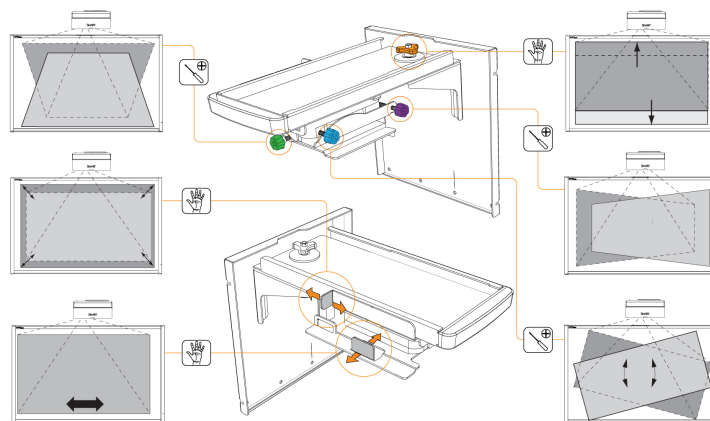

Use the mechanical adjustments described in the installation document and the image alignment screen to adjust the projected image size, shape and location so that you can see the full projected image clearly. Don't use other images, which might be cropped or scaled by the projector and result in a misleading projected image size, shape and location.

When adjusting keystone (tilt), ensure that the top and bottom edges of the image are horizontal before you position the left and right edges of the image relative to your interactive whiteboard.

To fine-tune the image, you might need to repeat all steps described in the installation document in smaller increments.

Projector connection diagram

You can connect a variety of peripheral devices to your projector, including DVD/Blu-ray players, document cameras, and other high-definition sources, as well as peripheral device outputs such as a secondary projector or other displays, and powered speakers.

 **NOTE**
 You might need to purchase third-party adapters to connect certain peripheral devices.

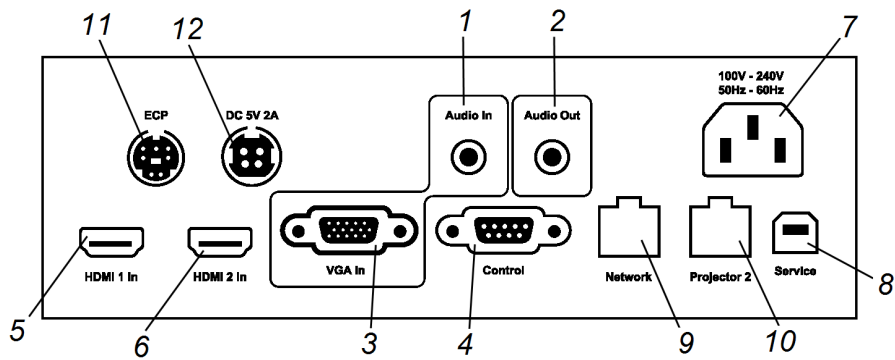

No.	Connector	Connect to:
1	3.5 mm phone jack audio input	Audio sources associated with the computer connected to the VGA video input source.
2	3.5 mm phone jack audio output	External speakers (optional, not included)
3	DB15F (DE-15F) RGB VGA video input	Secondary computer (optional, not included)
4	DB9F (DE-9F) RS-232	

No.	Connector	Connect to:
5	HDMI 1 In	Primary computer high-definition media (audio and video) source (not included)
6	HDMI 2 In	Additional high-definition media (audio and video) source (not included)
7	Power	Mains power supply
8	USB B	Do not use (for service access only)
9	RJ45 (8P8C modular connector)	Network (for web page management and SNMP access). Network connection only.
10	RJ45 (8P8C modular connector)	Projector 2 (for dual interactive whiteboard systems). Crossover cable connection only.
11	7-pin mini-DIN	Cable harness to interactive whiteboard
12	4-pin mini-DIN 5V/2A output	Cable harness to interactive whiteboard



IMPORTANT

The 4-pin mini-DIN 5V/2A output provides power to SMART products only.



NOTES

- To connect your SMART Board M685 interactive whiteboard see the *SMART Board M685ix2 interactive whiteboard system installation and cabling guide* (smarttech.com/kb/170440).
- To connect accessories to your interactive whiteboard, refer to the documents included with the accessories and consult the SMART Support website (smarttech.com/support) for additional information.

Integrating your system with peripheral devices

For information on integrating your SMART Board M685ix2 interactive whiteboard appliance-based systems with peripheral devices, see *Connecting peripheral sources and outputs* on page 80.

Chapter 3

Using your interactive whiteboard system

Using your projector	13
Using your remote control	13
Using the remote control buttons	14
Adjusting projector settings	15
Using your interactive whiteboard	22

This chapter describes the basic operation of your interactive whiteboard system and explains how to set up your remote control, retrieve system information, access the projector's image adjustment options and integrate your interactive whiteboard system with peripheral devices.

Using your projector

This section explains how to use your projector remote control to access on-screen menus and change projector setting.

Using your remote control

The projector remote control enables you to access on-screen projector menus and change projector settings.

Using the remote control buttons

The projector remote control enables you to access on-screen menus and change projector settings. Use the **Power**  button on the remote control to put the projector into Standby mode or to turn it on. You can also use the **Input** button on the remote control to switch sources on the projector.

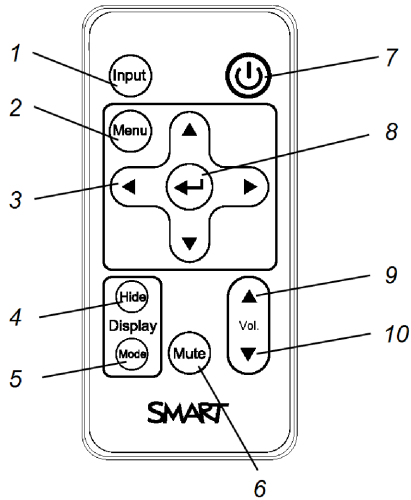

Number	Function	Description
1	Input	Select a video and audio input source on the projector and the associated USB input source on the ECP, if present.
2	Menu	Show or hide the projector menus.
3	◀ (Left), ▶ (Right), ▲ (Up) and ▼ (Down) arrows	Change the menu selections and adjustments.
4	Hide	Freeze, hide or display the image: <ul style="list-style-type: none"> • Press once to freeze the image. For example, you can display a question on the screen while you check your e-mail. • Press again to hide the image, that is, to display a black screen. • Press again to return to the live image.
5	Mode	Select a display mode.
6	Mute	Mute audio amplification.
7	 (Power)	Turn on the projector or put it into Standby mode.
8	↵ (Enter)	Accept the selected mode or option.
9	▲ (Volume Up)	Increase audio amplification volume.
10	▼ (Volume Down)	Decrease audio amplification volume.

 **NOTE**

The **Mute**, **Volume Up** and **Volume Down** buttons work only if there is an audio source connected to the projector for the selected video input source.

For information on using the remote control's Menu button to adjust the projector settings, see *Adjusting projector settings* on page 68.

Adjusting projector settings

The remote control's Menu button enables you to access the on-screen display to adjust the projector settings.

 **IMPORTANT**

Keep your remote control in a safe place because there is no other way to access menu options.

Setting	Use	Notes
 Image Adjustment menu		
Display Mode	Indicates the projector's display output (SMART Presentation , Bright Room , Dark Room , sRGB and User).	The default is SMART Presentation .
Brightness	Adjusts projector brightness from 0 to 100.	The default is 50.
Contrast	Adjusts the difference between the lightest and darkest parts of the image from 0 to 100.	The default is 50.
Frequency	Adjusts the display data frequency of the projected image from -5 to 5 to match the frequency of your computer's graphics card.	The default is 0. This setting applies to VGA inputs only.
Tracking	Synchronizes your projector's display timing with your computer's graphics card from 0 to 63.	This setting applies to VGA inputs only.

Setting	Use	Notes
H-Position	Moves the horizontal position of the source video left or right from 0 to 100 (relative to the projected image).	Don't adjust this setting unless you're advised to by SMART Support. Apply this setting only after you make all boom adjustments. This setting applies to VGA inputs only and is useful in situations where the source video is cut off.
V-Position	Moves the vertical position of the source video up or down from -5 to 5 (relative to the projected image).	Don't adjust this setting unless you're advised to by SMART Support. Apply this setting only after you make all boom adjustments. This setting applies to VGA inputs only and is useful in situations where the source video is cut off.
White Peaking	Adjusts the image color brightness from 0 to 10 while providing more vibrant white shades.	A value closer to 0 creates a natural image and a value closer to 10 enhances brightness. The default is 10.
Degamma	Adjusts the color performance of the display from 1 to 3.	The default is 2.
Color	Adjusts the Red, Green, Blue, Cyan, Magenta and Yellow colors on the projector from 0 to 100 to provide custom color and luminance output.	Each color has a default value of 100. Adjustments to the color settings register under the User mode.
 Audio menu		
Volume	Adjusts the projector's volume amplification from -20 to 20.	The default is 0.
Mute	Mutes the projector's audio output.	The default is off. If you mute the projector's audio output and then increase or decrease the volume, the volume is restored automatically. You can prevent this from happening by disabling the volume control.
Disable Volume Control	Disables the projector's volume control.	
System Output	Selects one or more speakers or other audio device.	Select Line Out+Speaker , Line Out Only or Speaker Only .



Setting	Use	Notes
 Projector Functions menu		
3D On/Off	Turns the DLP Link technology 3D feature on or off.	The default is off.
3D Format	Displays the current 3D format (Interleaved or Under-over).	Interleaved breaks down the image frame for each eye, alternately displaying a line of visual information from each frame. Under-over concurrently displays horizontally stretched image frames for each eye, one above the other.
3D Invert Left-Right	Selects the 3D Invert setting (L-R or R-L).	L-R displays visual data for the left eye first. R-L displays visual data for the right eye first.
Auto Signal Detect	Enables or disables signal searching of input connectors.	The default is off. Select On to have the projector continuously switch inputs until it finds an active video source. Select Off to maintain signal detection in one input.
Lamp Reminder	Turns the lamp replacement reminder on or off.	This reminder appears 100 hours before the recommended lamp replacement.
Lamp Mode	Adjusts lamp brightness to Standard or Economy .	Standard displays a high-quality, bright image. Economy increases the lamp life by decreasing the brightness of the image.
Auto Power Off (minutes)	Sets the length of the auto power-off countdown timer between 1 and 240 minutes.	The default is 120 minutes. The timer begins to count down when the projector no longer receives a video signal. The timer finishes when the projector enters Standby mode. Select 0 to turn off the timer.
Zoom	Adjusts the zoom to the center of the image in or out from 0 to 30.	The default is 0. Zooming in cuts off the outer edges of the source video.
Projector ID	Displays the projector's unique ID number (from 0 to 99) within your organization's network.	You can refer to or change this number when using the network remote management feature (see <i>Remotely managing your system through a network interface</i> on page 43).

Setting	Use	Notes
Aspect Ratio	Adjusts the image output to Fill Screen , Match Input or 16:9 .	<p>The default is Fill Screen.</p> <p>Fill Screen produces an image that fills the entire screen by stretching and scaling the source video to match the projector's native resolution and aspect ratio.</p> <p>Match Input displays the source video in its native resolution and aspect ratio. As a result, unused space could appear along the top and bottom edges of the screen (letterbox format) or along the left and right edges of the screen (pillarbox format).</p> <p>See <i>Video format</i> on page 77 for descriptions of each mode.</p>
Startup Screen	Selects the type of startup screen (SMART , Capture User Startup Screen , Preview Startup Screen), or Image Alignment Screen.	<p>This screen displays when the projector lamp is starting and a video source signal isn't displayed.</p> <p>SMART displays the default SMART logo on a blue background.</p> <p>Capture User Startup Screen closes the on-screen display menu and captures the entire projected image. The captured image is displayed the next time the on-screen display opens. (The capture can take up to one minute, depending on the complexity of the background graphic.)</p> <p>Preview Startup Screen enables you to preview the default or captured startup screen.</p> <p>Image Alignment Screen enables you to adjust the projected image size, shape and location.</p>
Image Alignment Screen	Enables you to adjust the projected image size, shape and location.	The image alignment screen appears the first time you start your projector. However, you can access it from the startup screen menu any time. Press Menu or Enter to close it.
Set to Default?	Resets projector settings to their default values.	<p>If you select Yes, all projector settings reset to their defaults, reversing any menu changes you made. This action is irreversible.</p> <p>Don't adjust this setting unless you want to reset all of the applied settings, or unless you're advised to by a SMART Support specialist.</p>

Setting	Use	Notes
USB Source Select	Opens a sub-menu that enables you to select the video input on your projector and the USB receptacle on the ECP.	The defaults are: <ul style="list-style-type: none"> • HDMI-1, USB 1 • HDMI-2, Disabled (no associated USB input) • VGA-1, USB 2
 Network menu		
Network	Activates the projector's RJ45 connector and network features.	
Status	Displays the current network status (Connected , Disconnected or Off).	The default is off.
DHCP	Displays the status of the network's Dynamic Host Configuration Protocol (DHCP) as On or Off .	The default is on. On enables a DHCP server on the network to automatically assign an IP address to the projector. Off enables an administrator to assign an IP address manually.
Password Reminder	E-mails the network password to the predefined e-mail recipient.	See <i>Web page management</i> on page 43 to set up a destination e-mail address.
IP Address	Displays the projector's current IP address in values between 0.0.0.0 and 255.255.255.255.	To change the projector's IP address, use the RS-232 connector or use a DHCP server to assign a dynamic IP address, and then set a static IP address using the network remote management feature (see <i>Remotely managing your system through a network interface</i> on page 43).
Subnet Mask	Displays the projector's subnet mask number in values between 0.0.0.0 and 255.255.255.255.	
Gateway	Displays the projector's default network gateway in values between 0.0.0.0 and 255.255.255.255.	

CHAPTER 3
USING YOUR INTERACTIVE WHITEBOARD SYSTEM

Setting	Use	Notes
DNS	Displays the projector's primary domain name server (DNS) IP address in values between 0.0.0.0 and 255.255.255.255.	
MAC Address	Displays the projector's MAC address in xx-xx-xx-xx-xx-xx format.	
Group Name	Displays the projector's workgroup name as set by an administrator (maximum 12 characters).	You can set the projector's workgroup name using the remote management features (see <i>Remotely managing your system through a network interface</i> on page 43 and <i>Remotely managing your system through an RS-232 serial interface</i> on page 53).
Projector Name	Displays the projector's name as set by an administrator (maximum 12 characters).	You can set the projector's name using the remote management features (see <i>Remotely managing your system through a network interface</i> on page 43 and <i>Remotely managing your system through an RS-232 serial interface</i> on page 53).
Location	Displays the projector's location as set by an administrator (maximum 16 characters).	You can set the projector's location using the remote management features (see <i>Remotely managing your system through a network interface</i> on page 43 and <i>Remotely managing your system through an RS-232 serial interface</i> on page 53).
Contact	Displays the contact name or number for projector support as set by an administrator (maximum 16 characters).	You can set the contact name or number using the remote management features (see <i>Remotely managing your system through a network interface</i> on page 43 and <i>Remotely managing your system through an RS-232 serial interface</i> on page 53).

Setting	Use	Notes
 Language menu		
Language	Selects language preference.	Projector menu support is available in English (default), Chinese (Simplified), Chinese (Traditional), Czech, Danish, Dutch, Finnish, French, German, Greek, Italian, Japanese, Korean, Norwegian, Polish, Portuguese (Brazil), Portuguese (Portugal), Russian, Spanish and Swedish.
 Information menu		
Lamp Hours	Displays the current number of lamp usage hours from 0 to 4000 hours from when it was last reset.	Always reset the lamp hours after you replace a lamp, because lamp service reminders are based on the current hours of use. See <i>Resetting the lamp hours</i> on page 27 for details on the lamp hours reset procedure.
Input	Displays the currently displayed video input source (VGA, HDMI1, HDMI2 or None).	
Resolution	Displays the projector's most recently detected video source signal resolution and refresh rate.	If there is no current video input source signal, this setting displays the last known source signal image resolution and refresh rate.
Firmware Version	Displays the projector's digital display processor (DDP) firmware version in x.x.x.x format.	
MPU Version	Displays the projector microprocessor unit (MPU) firmware version in x.x.x.x format.	
Network Version	Displays the projector's network communications processor firmware version in x.x.x.x format.	If you haven't enabled the Network and VGA Out setting, this setting is unable to display the projector's network communications processor firmware version and displays 0.0.0.0 instead.
Model Number	Displays the projector's model number.	
Serial Number	Displays the projector's serial number.	
UCP ports 1 / 2	Reserved for future application.	

Using your interactive whiteboard

Refer to the *SMART Board M600 series interactive whiteboard user's guide*

(smarttech.com/kb/170410) for in-depth information on using your interactive whiteboard and its features.

When you connect your SMART Board interactive whiteboard to a computer with SMART software, you can access the full capabilities of your interactive whiteboard.

For additional resources, go to smarttech.com, click the flag icon in the top-right corner, and then select your country and language. In the Support section of this website, you'll find up-to-date, product-specific information, including setup instructions and specifications.

The SMART training website (smarttech.com/training) includes an extensive library of training resources you can refer to when first learning to set up or use your interactive whiteboard system.

Chapter 4

Maintaining your interactive whiteboard system

Maintaining your interactive whiteboard	23
Preventing damage to your interactive whiteboard	23
Keeping the writing surface clean	24
Cleaning the projector	25
Focusing and adjusting the projector image	25
Removing and replacing the projector lamp module	25
Resetting the lamp hours	27
Replacing the remote control battery	28

This chapter includes methods for properly cleaning and preventing damage to your SMART Board interactive whiteboard system.

Maintaining your interactive whiteboard

With proper care, your SMART Board interactive whiteboard will provide years of trouble-free service.

Preventing damage to your interactive whiteboard

Although the surface of your interactive whiteboard is very durable, take the following precautions to prevent damage.

- Don't use sharp or pointed objects, such as ballpoint pens or pointers, as writing tools.
- Replace the pen nib when the nib wears out.
- Don't use low-odor dry-erase markers because they can be very difficult to erase. Use standard (high-odor) dry-erase markers that show a warning to use them only in well-ventilated areas.
- Don't use adhesive tape on the interactive surface.
- Don't use abrasive erasers or harsh chemicals to clean your product.

- The digital cameras located in the corners of the frame are protected from dust and dirt by windows. In extremely dusty environments, spray a household, alcohol-free glass cleaner, such as Windex® cleaner, on a cotton swab and rub it gently on the windows. Don't use compressed air to clean the cameras.

Keeping the writing surface clean

Follow these tips to keep the interactive whiteboard's surface clean.

- Clean your interactive whiteboard at least every six months.
- Don't spray cleaner directly onto the interactive whiteboard's surface. Instead, spray a light amount of cleaner on a cloth and then gently wipe the interactive surface.



IMPORTANT

Turn off your interactive whiteboard system before you clean it so that you do not scramble the desktop icons or inadvertently activate applications when you wipe the interactive surface.



TIP

To view dirt or streaks more easily, set your projector to Standby (lamp off) mode.

Cleaning the projector

WARNING

Cleaning a wall-mounted projector can result in a fall or injury. Use caution when climbing a ladder.

CAUTION

- Before you clean the projector, press the **Power**  button twice on the remote control to put the system in Standby mode, and then wait 30 minutes for the lamp to cool completely.
- Never touch the lens or the mirror with your hands or a brush.
- Do not allow liquids or commercial solvents of any kind to flow into the projector base or head.

Do not spray cleaners or solvents near any part of the projector because they can spread a chemical mist on some of the projector's components and lamp, resulting in damage, staining or poor image quality.

- Do not use compressed air to clean the projector.

When cleaning the projector's lens or mirror:

- Use a bellows bulb or air blower bulb (commonly found in audio-visual supply stores) to blow off dust.
- If wiping the lens or mirror is unavoidable, wear protective gloves and gather the cleaning cloth into a ball. Gently fan the cleaning cloth across the lens or mirror like you would a feather duster. Do not apply any pressure to the lens or mirror.

Focusing and adjusting the projector image

For information on focusing and adjusting the projector image, see *Setting up the projector image* on page 9.

Removing and replacing the projector lamp module

Eventually the lamp module will dim, and a message will appear reminding you to replace the lamp. Make sure you have a replacement projector lamp module before proceeding.

For instructions on how to replace the projector lamp module, go to smarttech.com/kb/170389.

 **WARNING**

- Replace the lamp when the projector displays its lamp life warning message. If you continue to use the projector after this message appears, the lamp can shatter or burst, scattering glass throughout the projector.
- If the lamp shatters or bursts, leave and then ventilate the area.

Next do the following:

- Avoid touching the glass fragments because they can cause injury.
- Wash your hands thoroughly if you have come into contact with lamp debris.
- Thoroughly clean the area around the projector, and discard any edible items placed in that area because they could be contaminated.
- Call your authorized SMART reseller for instructions. Do not attempt to replace the lamp.
- When replacing the projector lamp:
 - Put the projector into Standby mode and wait 30 minutes for the lamp to cool completely.
 - Do not remove any screws other than those specified in the lamp replacement instructions.
 - Wear protective eyewear while changing the lamp. Failure to do so can cause injuries including loss of eyesight if the lamp shatters or bursts.
 - Use only replacement lamps approved by SMART Technologies. Contact your authorized SMART reseller for replacement parts.
 - Never replace the lamp module with a previously used lamp module.
 - Always handle the fragile lamp module with care to prevent premature lamp failure or exposure to mercury. Use gloves when touching the lamp. Do not touch the lamp with your fingers.
 - Recycle or dispose of the lamp module as hazardous waste in accordance with local regulations.
- See [smarttech.com/compliance](https://www.smarttech.com/compliance) for the projector's Material Safety Data Sheets (MSDS) documents.

 **IMPORTANT**

Fully close the lamp door on the projector after replacing the lamp module. If the lamp door is not fully closed, a safety switch turns off power to the projector.

Resetting the lamp hours

After you replace the lamp module, you need to access the projector service menu to reset the lamp hours. To prevent accidental errors, only a system administrator should perform this procedure.

NOTE

Always reset the lamp hours after you replace the lamp, because lamp service reminders are based on the current hours of use.

To reset the lamp hours

1. Using the remote control, press the following buttons quickly to access the service menu:
Down, Up, Up, Left, Up.

CAUTION

Do not adjust any settings in the service menu other than those listed in this guide. Changing other settings can damage or affect the operation of your projector and may invalidate your warranty.

2. Scroll down to *Lamp Hour Reset* and then press **Enter**.

CAUTION

Do not reset the lamp hours unless you have just replaced the lamp module. Resetting the lamp hours on an old lamp can damage your projector as a result of lamp failure.

3. Scroll down to *Exit* and then press **Enter** to exit the projector service menu.

Replacing the remote control battery

Follow this procedure to replace the remote control battery.

WARNING

- Reduce the risk associated with a leaking battery in the projector's remote control by following these practices:
 - Use only the specified CR2025 coin-cell battery.
 - Remove the battery when the remote control is unused for an extended period.
 - Do not heat, disassemble, short or recharge the battery, or expose it to fire or high temperatures.
 - Avoid eye and skin contact with the battery if it has a leak.
- Dispose of the exhausted battery and product components in accordance with applicable regulations.

To replace the remote control battery

1. Hold down the side release on the left side of the battery holder and pull the battery holder completely out of the remote control.

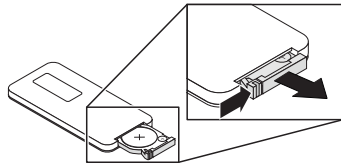

2. Remove the old battery from the battery holder and replace it with a CR2025 coin-cell battery.

IMPORTANT

Align the battery's positive (+) and negative (-) terminals with the correct signs on the battery holder.

3. Insert the battery holder into the remote control.

Chapter 5

Troubleshooting your interactive whiteboard system

Before you start	30
Locating status lights	30
Locating serial numbers	31
Determining you interactive whiteboard system's status	32
Resolving interactive whiteboard issues	33
Resolving operation issues	33
Resolving projector issues	34
Resolving projector errors	34
Your projector stops responding	34
The "Projector Overheated", "Fan Failure", "Lamp Failure" or "Color Wheel Failure" message appears	34
The "Lamp Failure" message appears	35
The projector Power and Service lights are off	35
Resolving image issues	36
Loss of signal	36
Partial, scrolling or incorrectly displayed image	37
Unstable or flickering image	37
Frozen image	38
The image from your connected laptop computer isn't projected	38
Unaligned projected image	38
Resolving audio issues	39
Resolving network communication issues	40
Accessing the service menu	41
Retrieving your password	41
Resetting the projector	42
Transporting your interactive whiteboard system	42

This chapter provides basic troubleshooting information for your interactive whiteboard system.

For issues not covered in this chapter, consult the SMART Support website (smarttech.com/support) or contact your authorized SMART reseller (smarttech.com/where).



Before you start

Before you troubleshoot your interactive whiteboard system or contact SMART Support or your authorized SMART reseller for assistance, you need to do the following:

- Locate your interactive whiteboard system's status lights
- Locate your interactive whiteboard system's serial numbers

Locating status lights

Your interactive whiteboard system consists of several components, which have their own status lights:

- The **Select** button on your interactive whiteboard's pen tray also functions as a status light.
- Your projector's Power  and Service  lights are located on the bottom of the projector.

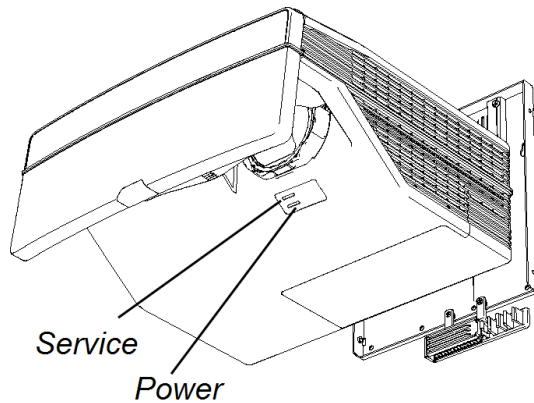

Locating serial numbers

The SMART Board M600 series interactive whiteboard serial number is located on the lower-right edge of the frame, as well as on the back of the interactive whiteboard. For more information, see the *SMART Board M600 series interactive whiteboard user's guide* (smarttech.com/kb/170410).

The SMART UX80 projector's serial number is located on the top of the projector.

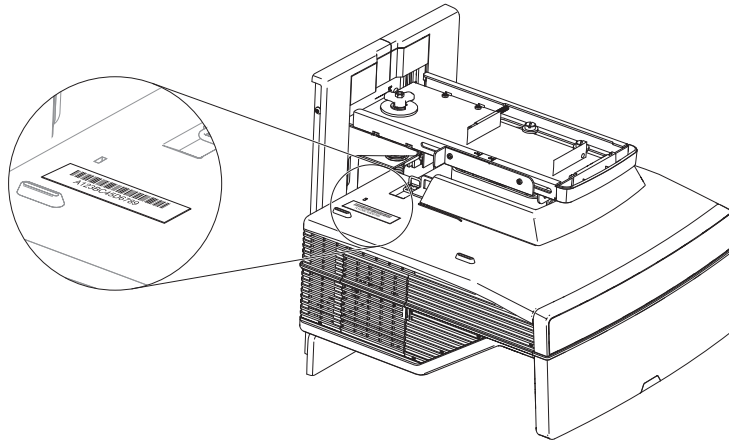

The serial number is also located at the bottom of the projector and can be seen when you stand on the floor and look up at the projector. Open the cable cover at the bottom of the projector and locate the serial number next to the cable connectors.

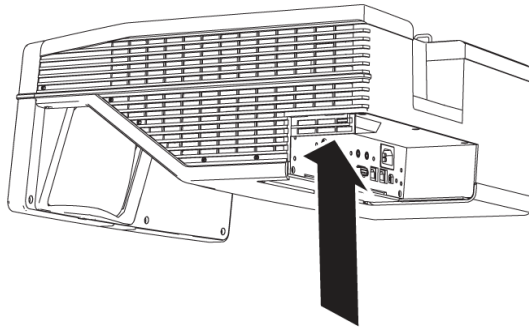



TIP



You can also access the projector's serial number through the on-screen menu. For more information, see *Adjusting projector settings* on page 68.

For the locations of serial numbers on other components and accessories, see smarttech.com/support.

Determining you interactive whiteboard system's status

Use the following table to determine the status of your interactive whiteboard system.

 Projector Power light	 Projector Service light	Pen tray Select button status light	Projected image	Touch and pen control	Status and related troubleshooting
Normal operating statuses					
Solid green	Off	Solid white	Correct	Full control	The system is operating normally. If image or sound issues occur, see the remaining sections of this chapter for troubleshooting information.
Flashing green	Off	Off	None	None	The system is starting up.
Solid amber	Off	Off	None	None	The system is in Standby mode.
Flashing amber	Off	Off	None	None	The system is entering Standby mode.
Solid green	Off	Solid amber	N/A	None	The interactive whiteboard's controller module is ready to receive a firmware update or is applying a firmware update.
Error statuses					
Solid green	Off	Solid white	Incorrect	Full control	There's an issue with the projected image. See <i>Resolving image issues</i> on page 36.
Solid green	Off	Solid white	Correct	None	There's an issue with the interactive whiteboard. See <i>Resolving operation issues</i> on the next page.
Solid green	Off	Flashing white	Correct	Touch only	SMART Product Drivers isn't installed or isn't running correctly on the connected computer.
Solid green	Off	Off	N/A	None	There's an issue with the connections between the interactive whiteboard and the other components of the system. See <i>Resolving interactive whiteboard issues</i> on the next page.
Solid amber	Flashing red	N/A	None	N/A	There's an issue with the projector lamp. See <i>The "Lamp Failure" message appears</i> on page 35.

 Projector Power light	 Projector Service light	Pen tray Select button status light	Projected image	Touch and pen control	Status and related troubleshooting
Off	Flashing red	Off	None	None	The projector's operating temperature has been exceeded. See <i>The "Projector Overheated", "Fan Failure", "Lamp Failure" or "Color Wheel Failure" message appears on the next page.</i>
Off	Solid red	N/A	None	N/A	There's an issue with the projector's fan or color wheel. See <i>The "Projector Overheated", "Fan Failure", "Lamp Failure" or "Color Wheel Failure" message appears on the next page.</i>
Solid amber	Solid red	N/A	None	None	Contact SMART Support.
Off	Off	Off	None	None	The projector power cable isn't properly connected. OR There's an issue with the mains power supply (for example, the circuit breaker is off). OR The projector's lamp door is open. Fully close the lamp door.

Resolving interactive whiteboard issues

This section includes information on resolving issues with your interactive whiteboard.

For information not covered in this section, see the *SMART Board M600 series interactive whiteboard user's guide* (smarttech.com/kb/170410).

Resolving operation issues

To resolve operation issues, complete the following tasks:

- Confirm that all cables are securely connected to the back of the pen tray, computer and control module.
- Perform the calibration procedure documented in the *SMART Board M600 series interactive whiteboard user's guide* (smarttech.com/kb/170410).
- Reset the interactive whiteboard system by disconnecting the power cable from the wall outlet and then connecting it.
- If necessary, complete additional troubleshooting with the guidance of SMART Support using SMART Board Diagnostics.

Resolving projector issues

Resolving projector errors

System administrators can resolve the following projector errors on their own prior to contacting SMART Support. Performing initial troubleshooting on your projector reduces the time of a support call.

Your projector stops responding

If your projector stops responding, perform the following procedure.

To restart an unresponsive projector

1. Put the projector into Standby mode, and then wait 30 minutes for it to cool down.
2. Disconnect the power cable from the power outlet, and then wait at least 60 seconds.
3. Connect the power cable, and then turn on the projector.

The “Projector Overheated”, “Fan Failure”, “Lamp Failure” or “Color Wheel Failure” message appears

If the “Projector Overheated”, “Fan Failure” or “Color Wheel Failure” message appears and the projector stops projecting an image, one of the following issues is occurring:

- The temperature is overheating but the “Projector Overheated” message fails to display.
- The temperature outside the projector is too high.
- One of the fans has failed.
- The projector has a color wheel issue.

To resolve the “Projector Overheated”, “Fan Failure”, or “Color Wheel Failure” error

1. Put the projector into Standby mode, and then wait 30 minutes for it to cool down.
2. If your room is hot, lower the temperature if possible.
3. Ensure that nothing is blocking the projector’s air intake and exhaust.
4. Disconnect the power cable from the power outlet, and then wait at least 60 seconds.
5. Connect the power cable, and then turn on the projector.
6. Adjust the fan speed using the service menu.
7. If the previous steps don’t resolve the issue, put the projector into Standby mode, disconnect the power cable, and then contact your authorized SMART reseller.

The “Lamp Failure” message appears

If the “Lamp Failure” message appears, one of the following issues is occurring:

- The lamp is overheating, likely due to blocked air vents.
- The lamp has reached the end of its life.
- The projector has an internal problem.

To resolve the “Lamp Failure” error

1. Restart the projector (see *Your projector stops responding* on the previous page).
2. Check the remaining lamp hours using the on-screen menu (see *Adjusting projector settings* on page 68).

If the lamp has more than 2000 hours of use in Standard mode or 3000 hours of use in Economy mode, it’s near the end of its lifespan.

3. Replace your lamp as described in *Removing and replacing the projector lamp module* on page 25.
4. If replacing the lamp module doesn’t resolve the issue, put the projector into Standby mode, disconnect the power cable, and then contact your authorized SMART reseller.

The projector Power and Service lights are off

If the projector Power and Service lights are both off, one of the following issues is occurring:

- There was a power outage or a power surge.
- A circuit breaker or a safety switch was tripped.
- The projector isn’t connected to the power source.
- The projector has an internal problem.
- The projector’s lamp door is open.

To resolve the unlit projector Power and Service lights issue

1. Check the power source, and then make sure that all cables are connected.
2. Confirm that the projector is connected to an active power outlet.
3. Make sure the pins on the connectors aren’t broken or bent.
4. Check that the projector’s lamp door is installed properly and the lamp door is fully closed.
5. Connect the power cable, and then turn on the projector.

6. If the previous steps don't resolve the issue, disconnect the power cable and then contact your authorized SMART reseller.

Resolving image issues

To resolve common image issues, complete the following tasks:

- Ensure the computer or other video source is on and set to display a resolution and refresh rate supported by the projector (see *Video format* on page 77).
- Ensure the video source is properly connected to the projector.
- Press the **Input** button on the remote control or the **Input Select** button on the pen tray to switch to the correct video source.

If these tasks don't resolve the issue, refer to the following sections for additional troubleshooting information.

Loss of signal

If a video source signal isn't detected, if it's out of range of the projector's support video modes or if the signal is being switched to a different device or input, the projector doesn't show a source signal and instead displays the SMART logo on a blue screen.



To resolve signal loss issues

1. Wait approximately 45 seconds for the image to synchronize. Some video signals require a longer synchronization period. Cycling back through inputs to the one you want also helps image synchronization.
2. If the image doesn't synchronize, check your cable connections to the projector.
3. Ensure that the image signal is compatible with the projector (see *Video format* on page 77).
4. If there are any extension cables, switch boxes, connection wall plates or other devices in the video connection from the computer to the projector, temporarily remove them to ensure they aren't causing the video signal loss.
5. If your projector still doesn't show a source signal, contact your authorized SMART reseller.

Partial, scrolling or incorrectly displayed image

NOTE

This procedure may vary depending on your version of Windows® operating system or Mac OS X operating system software and your system preferences. The following procedures apply to Windows 7 operating systems and Mac OS X 10.8 operating system software.

To resolve a partial, scrolling or incorrectly displayed image on your Windows computer

1. Select **Start > Control Panel**.
2. Click **Display**, and then select **Adjust resolution**.
3. Verify that your display resolution setting is 1280 × 800 (WXGA).
4. Click **Advanced settings**, and then click the **Monitor** tab.
5. Verify that the screen refresh rate is 60 Hz.

To resolve a partial, scrolling or incorrectly displayed image on your Mac computer

1. Select **Apple Menu > System Preferences**.
The *System Preferences* dialog box appears.
2. Click **Displays**.
3. Verify that your display resolution setting is 1280 × 800 (WXGA).
4. Verify that the screen refresh rate is 60 Hz.

Unstable or flickering image

If the projector's image is unstable or flickering, the frequency or tracking settings on your input source could be different from the settings on your projector.

IMPORTANT

Write down your setting values before adjusting any of the settings in the following procedure.

To resolve your unstable or flickering image

1. Check the display mode of your computer's graphics card. Make sure it matches one of the projector's compatible signal formats (see *Video format* on page 77). Refer to your computer's manual for more information.
2. Configure the display mode of your computer's graphics card to make it compatible with the projector. Refer to your computer's manual for more information.

3. Adjust the frequency, tracking, H-position and V-position settings in the on-screen menu. See *Adjusting projector settings* on page 68.
4. Optionally, reset the projector as described in *Resetting the projector* on page 42 to adjust the frequency and tracking to their original values.



IMPORTANT

This action resets all values to their defaults.

Frozen image

If your projector has a frozen image, perform the following procedure.

To resolve a frozen image

1. Ensure that the Hide Display feature is off.
2. Press the **Hide** button on the projector's remote control to hide or show the display.
3. Ensure that your source device, such as your DVD player or computer, isn't malfunctioning.
4. Put the projector into Standby mode, and then wait 30 minutes for it to cool down.
5. Disconnect the power cable from the power outlet, and then wait at least 60 seconds.
6. Connect the power cable, and then turn on the projector.
7. If the previous steps don't resolve the issue, contact your authorized SMART reseller.

The image from your connected laptop computer isn't projected

Laptop computer settings can interfere with projector operations.

Some laptop computers deactivate their screens when you connect a secondary display. Refer to your computer's manual for details on reactivating the computer's display screen.

Unaligned projected image

Alignment errors occur when the projected image isn't perpendicular to the screen. Alignment errors can occur when you mount your interactive whiteboard system on an uneven surface or a wall that has obstructions, or if you swivel the projector too far from the vertical center of your interactive whiteboard.

Use the instructions in the included *SMART Board M685ix2 interactive whiteboard systems installation instructions* (smarttech.com/kb/170440) to eliminate most image alignment issues.

The projector image can slip if the projector is moved often or installed in a location prone to vibration, such as next to a heavy door. Follow these precautions to help prevent the image from becoming unaligned:

- Make sure that the installation wall is plumb and square and doesn't move or vibrate excessively.
- Make sure that there are no obstructions behind the projector's wall-mounting bracket, and that the bracket is firmly secured to the wall according to the installation instructions.
- Confirm that all cables are held in place with the appropriate cable management clip.
- Adjust the projected image. See the included *SMART Board M685ix2 interactive whiteboard system textless installation guide* (smarttech.com/kb/170440) and *Aligning the image* on page 10.

Resolving audio issues

The projector includes an internal speaker. You can also connect an external audio system to the audio output connector in the projector's connection panel. If sound isn't coming from either your internal speaker or your external audio system, perform the following procedures.

NOTE

You might need to configure your computer to pass audio through HDMI if it isn't configured automatically.

To resolve audio issues, complete the following tasks:

- If you are using optional external speakers or an external audio system, ensure that the speakers' or audio system's cables are properly connected to the audio output plug on the projector's connection panel.
- For the purpose of troubleshooting, enable both the internal and external speakers by ensuring that the System Output Switch in the audio menu is set to **Line Out + Speaker**.
- Ensure that the video cable from your computer is connected to the appropriate video connector on your projector.
- If you're using a VGA cable, ensure that the analog audio cable from your computer's audio output is connected to the projector's VGA audio input connector.
- Press the **Mute** button on the projector's remote control, and if Audio Mute is on, turn it off.
- Use the projector's remote control to ensure that the volume isn't at the lowest setting.

- If you're using an external audio system, ensure that your speaker or audio system is on and that the volume is turned up.
- Check that your video source input, such as your computer or video device, isn't malfunctioning. Ensure that its audio output is on and that the volume isn't set to the lowest position.



NOTE

You must display the source input's video to play its audio through the connected speakers or audio system.

- Ensure that the correct audio output device is selected in your computer's Sound settings.
- If your computer's video signal is connected with an HDMI cable, ensure that your computer's audio output is also configured to output audio via the same HDMI cable. If your computer's video signal is connected with a VGA cable, ensure that your computer's audio output is configured to use its analog audio cable connected between the computer and the projector.



NOTE

If you're using an HDMI video input on the projector, do not use any DVI to HDMI adapters, as these will not transfer audio from the DVI source to the HDMI input on the projector.

- If the previous steps don't resolve the issue, contact your authorized SMART reseller.

Resolving network communication issues

If you don't have network access, perform the following procedure to troubleshoot your system.

To resolve network communication issues

1. Ensure that your network cable is properly connected to the RJ45 connection on the projector's connection panel. There are two RJ45 ports: one is for the network and one is for projector 2. Ensure that the network cable is connected to the correct one.
2. Ensure that the LAN warning light on the projector is green. To activate the projector's network features, use the "vgaoutnetenable=on" RS-232 command (see *Projector programming commands* on page 56) or enable the **Network and VGA Out** setting (see *Adjusting projector settings* on page 68). The network features on the projector don't work until you complete one of these tasks.

Ensure that the network is enabled in the projector's OSD.

3. Press the **Menu** button, and then select the **Network Settings** menu to check the IP address. See *Adjusting projector settings* on page 68 for a description of the IP address field. Enter this IP address into your browser or SNMP agent.
4. If you still don't have network access, contact your network administrator. If your administrator is unable to resolve the issue, contact your authorized SMART reseller.

Accessing the service menu

CAUTION

- To prevent tampering or unintentional changes, only system administrators should access the service menu. Do not share the service menu access code with casual users of your interactive whiteboard system.
- Do not adjust any settings in the service menu other than those listed in this guide. Changing other settings can damage or affect the operation of your projector and may invalidate your warranty.

Retrieving your password

If you forget the projector's password, you can retrieve it by accessing the projector service menu directly from the projector or from the password settings menu on your projector's web page (see *Password settings* on page 50).

To retrieve your password from the service menu

1. Using the remote control, press the following buttons quickly to access the service menu:
Down, Up, Up, Left, Up.
2. Scroll to *Password Get*, and then press **Enter** on the remote control.

The password appears on the screen.
3. Write down the password.
4. Scroll to *Exit*, and then press **Enter** on the remote control to exit the projector service menu.

Resetting the projector

At some point during troubleshooting, you might need to reset all projector settings.



IMPORTANT

This action is irreversible.

To reset all projector settings

1. Using the remote control, press the following buttons quickly to access the service menu:
Down, Up, Up, Left, Up.
2. Scroll to *Factory Reset*, and then press **Enter** on the remote control.
3. Scroll to *Exit*, and then press **Enter** on the remote control to exit the projector service menu.

Transporting your interactive whiteboard system

Save your original interactive whiteboard system packaging so that it's available if you need to transport your interactive whiteboard system. When required, repack it with all of the original packaging. This packaging was designed to provide optimal shock and vibration protection. If you no longer have your original packaging, purchase the same packaging directly from your authorized SMART reseller.

If you prefer to use your own packaging materials, make sure you adequately protect your unit. Make sure that the projector lens and mirror are protected against any physical contact or pressure which may damage the projector's optics. Ship your interactive whiteboard in an upright position to deter shippers from placing heavy objects on it.

Appendix A

Remotely managing your system through a network interface

Web page management	43
Accessing web page management	44
Home	44
Control panel	44
Control panel II	47
Failurelog	48
Network settings	48
E-mail alerts	49
Password settings	50
Simple Network Management Protocol (SNMP)	51
Crestron® RoomView®	51

This chapter includes detailed instructions on how to remotely manage your SMART Board interactive whiteboard system settings through a network interface.

Web page management

You can access advanced setup features via the projector's web page. This web page enables you to manage the projector from a remote location using any computer connected to your intranet.



NOTES

- To access the web page, your browser must support JavaScript. Most commonly used browsers like Internet Explorer®, Chrome™ and Firefox® support JavaScript.
- The SMART UX80 projector uses HTTP/1.1, HTML 4.01 and CSS 2.1 specifications.

Accessing web page management

Before you can access the web page, connect your projector to the network, and then enable the projector's network functions using the projector's menu. An IP address appears on the on-screen display.

NOTE

You can view the projector's IP address by accessing the projector's Network Settings menu page (see *Network settings* on page 48).

To use the management web page

1. Start your Internet browser.
2. Type the IP address in the address box, and then press ENTER.
The SMART UX80 Projector Settings window appears.
3. Select the menu options in the left pane to access the settings on each page.
4. Modify settings using your computer's mouse and keyboard, and then click **Submit** or another action button next to each setting you change.

Home

The Home menu page displays basic projector information and enables you to select the on-screen display language.

NOTE

You can view basic projector information but you're unable to change it (with the exception of the on-screen display language) from the Home menu page.

Submenu setting	Description
Language	Displays language options
Projector Information	Displays current projector information



Control panel



This menu enables you to manage the projector audio and video status, alerts and appearance using an Internet browser.

NOTE

Image Adjustment settings displays only settings applicable to the active video source.

Submenu setting	Description
Power	Turns the projector on or puts it into Standby mode. Select the Power ON or Power OFF button.
Restore All Projector Defaults	Returns projector settings to default values or refreshes the current settings. Select Submit or Refresh . <div style="background-color: #f0f0f0; padding: 5px; margin-top: 5px;">  IMPORTANT The Submit option is irreversible and resets all values. </div>
Volume	Adjusts the projector's volume from -20 to 20.
Mute	Turns on or turns off the mute settings. Select On to mute the projector's sound and Off to turn off mute.
Volume Control	Enables volume control. Select On to enable volume adjustment and select Off to disable volume adjustment if you prefer to use your audio system or speaker (not included) controls.
Closed Captioning	Turns on or turns off the closed captioning feature.
Display Mode	Adjusts the display output to SMART Presentation , Bright Room , Dark Room , sRGB and User modes so you can project images from various sources with consistent color performance: <ul style="list-style-type: none"> • SMART Presentation is recommended for color fidelity. • Bright Room and Dark Room are recommended for locations with those conditions. • sRGB provides standardized accurate color. • User enables you to apply your own settings.
Brightness	Adjusts projector brightness from 0 to 100.
Contrast	Adjusts the difference between the lightest and darkest parts of the image from 0 to 100.
Frequency	Adjusts the display data frequency of the projected image from -5 to 5 to match the frequency of your computer's graphics card.
Tracking	Synchronizes your projector's display timing with your computer's graphics card from 0 to 31.
Sharpness	Adjusts the projected image's sharpness from 0 to 31.
White Peaking	Adjusts the image color brightness from 0 to 10 while providing more vibrant white shades. A value closer to 0 creates a natural image and a value closer to 10 enhances brightness.
Degamma	Adjusts the color performance of the display from 0 to 3.
Color	Adjusts the Red, Green, Blue, Cyan, Magenta and Yellow colors on the projector from 0 to 100 to provide custom color and luminance output. Each color has a default value of 100. Adjustments to the color settings register to the User mode.

Submenu setting	Description
Auto Signal Detect	Enables or disables signal searching of input connectors. <ul style="list-style-type: none">• Select On to have the projector continuously switch inputs until it finds an active video source.• Select Off to maintain signal detection in one input.
Lamp Reminder	Select On to show or Off to hide the lamp replacement reminder when it appears. This reminder appears 100 hours before the recommended lamp replacement.
Lamp Mode	Adjusts lamp brightness to Standard or Economy . Standard displays a high-quality, bright image. Economy increases the lamp life by decreasing the brightness of the image.
Auto Power Off	Sets the length of the auto power off countdown timer between 1 and 240 minutes. The timer begins to count down when the projector no longer receives a video signal. The timer finishes when the projector enters Standby mode. Select 0 to turn off the timer.
Zoom	Adjusts the zoom to the center of the image in or out from 0 to 30.
H-position (RGB input)	Moves the horizontal position of the source video left or right from 0 to 100 (relative to the projected image). <div data-bbox="685 1010 1463 1115"> NOTE This is useful in situations where the source video is cut off.</div>
V-position (RGB input)	Moves the vertical position of the source video up or down from -5 to 5 (relative to the projected image). <div data-bbox="685 1205 1463 1310"> NOTE This is useful in situations where the source video is cut off.</div>
Aspect Ratio	Adjusts the image output to Fill Screen , Match Input or 16:9 . <ul style="list-style-type: none">• Fill Screen produces an image that fills the entire screen by stretching and scaling.• Match Input matches the projector's aspect ratio to the input's aspect ratio. As a result, black bands might appear along the top and bottom edges of the screen horizontally (letterbox format) or along the left and right edges of the screen vertically (pillarbox format).• 16:9 changes the output to 16:9 by letterboxing the image, which is recommended for use with HDTV and DVDs enhanced for wide-screen television. <div data-bbox="685 1717 1463 1822"> NOTE See <i>Video format</i> on page 77 for descriptions of each mode.</div>

Submenu setting	Description
Startup Screen	Sets the type of startup screen to SMART or User . The SMART screen is the default SMART logo on a blue background. The User screen uses the saved picture from the Capture User Startup Screen function.
High Speed Fan	Adjusts the speed of the projector's fan. Select High or Normal . <div style="background-color: #f0f0f0; padding: 5px; margin-top: 10px;">  NOTE Use the High setting when the projector's temperature is high or the altitude is above 6000' (1800 m). </div>
Projector Mode	Adjusts the projection mode to Front , Ceiling , Rear or Rear Ceiling . <div style="background-color: #f0f0f0; padding: 5px; margin-top: 10px;">  IMPORTANT SMART recommends that you never change this setting from the Ceiling projection mode. </div>
Source	Adjusts the input source to VGA , HDMI1 or HDMI2 .
SMART Fixed Install (FI) / SMART Desktop mode (DT)	User-defined tag not currently used. Reserved for future application.
HDMI1	Assigns an alternative name to your HDMI1 input, which appears when you select the HDMI1 input.
HDMI2	Assigns an alternative name to your HDMI2 input, which appears when you select the HDMI2 input.
VGA1	Assigns an alternative name to your VGA 1 input, which appears when you select the VGA 1 input.
Emergency Alert	Turns the on-screen alert broadcast message on or off. When enabled, this message displays over the current projected image.
Alarm Message / Alert Message	Displays an on-screen emergency notification message (maximum 60 characters).

Control panel II

This menu enables you to manage the projector 3d feature settings.

Submenu setting	Description
USB1 Source	Associates the input source to VGA , HDMI1 or HDMI2 .
USB2 Source	Associates the input source to VGA , HDMI1 or HDMI2 .

Failurelog



This menu enables you to view projector service details such as lamp hours, display hours, temperature and lamp voltage on failure types such as lamp error and system overtemp.

Failurelog	Type	Lamp hours (hr.)	Display hours(hr.)	Temperature (□)	Lamp voltage (V)
1	Lamp Error	159	178	47	0
2	System Overtemp	3046	153	57	93
3	System Overtemp	3046	152	60	91
4	System Overtemp	146	152	57	100
5	Lamp Error	146	152	55	0

Network settings

This menu allows you to use or not use Dynamic Host Control Protocol (DHCP) and to set the network-related addresses and names when DHCP isn't used.

Submenu setting	Description
DHCP	Determines if the projector's IP address and other network settings are dynamically assigned by a DHCP server or are manually set. <ul style="list-style-type: none"> • On allows the network's DHCP server to assign a dynamic IP address to the projector. • Off allows you to manually set the projector's IP address and other network settings.
IP Address	Displays or allows you to set the projector's IP address in values between 0.0.0.0 and 255.255.255.255.
Subnet Mask	Displays or allows you to set the projector's subnet mask number in values between 0.0.0.0 and 255.255.255.255.
Gateway	Displays or allows you to set the projector's default network gateway in values between 0.0.0.0 and 255.255.255.255.
DNS	Displays or allows you to set the projector's IP address for your network's primary domain name server in values between 0.0.0.0 and 255.255.255.255.
Group Name	Displays or allows you to set the projector's workgroup name (maximum 12 characters).

Submenu setting	Description
Projector Name	Displays or allows you to set the projector's name (maximum 12 characters).
Location	Displays or allows you to set the projector's location (maximum 16 characters).
Contact	Displays or allows you to set the contact name or number for projector support (maximum 16 characters).
SNMP Enable	Turns the Simple Network Management Protocol (SNMP) agent on or off.
Read-Only Community	Sets a password that is required for each SNMP get request to the device.  NOTE The default for Read-Only Community is public.
Read/Write Community	Sets a password that is required for each SNMP set request to the device.  NOTE The default for Read/Write Community is private.
TRAP Destination Address	Displays or allows you to set the IP address of the network's SNMP TRAP manager in values between 0.0.0.0 and 255.255.255.255. The TRAP destination address is the IP address of the computer assigned to handle unsolicited data generated by SNMP TRAP events generated by the projector, such as power state changes, projector failure modes, a lamp needing to be replaced or other issues.

E-mail alerts

This menu enables you to enter your preferred address for receiving e-mail alerts and to adjust related settings.

Submenu setting	Description
E-mail Alert	Select Enable to turn on or Disable to turn off the e-mail alert function.
To	Displays or allows you to set the e-mail address of the e-mail alert recipient.
CC	Displays or allows you to set the e-mail address of the e-mail alert "copy to" recipient.
From	Displays or allows you to set the e-mail address of the user who sends the e-mail alert.

Submenu setting	Description
Outgoing SMTP server	Displays or allows you to set the Simple Mail Transfer Protocol (SMTP) server that you use on your network.
Username	Displays or allows you to set the SMTP server user name.
Password	Displays or allows you to set the SMTP server password.
Alert Condition	<p>Sends e-mail alerts whenever the following conditions occur. Select the settings you want, and then click Submit.</p> <ul style="list-style-type: none">• Over Temperature• Fan Failure: DMD• Fan Failure: System• Fan Failure: Blower• Lamp Error• Color Wheel Break• Lamp Ignite Error• Lamp Driver Failure• Lamp Over Hours

 **NOTE**

The projector sends an alert e-mail (SMART Alert) to your e-mail address. Click **E-mail Alert Test** to confirm that your e-mail address and SMTP server settings are correct by sending a test e-mail (SMART Alert-Test Mail).

If the settings aren't correct, the e-mail alert messages aren't sent or received successfully and warnings and notification message aren't available to advise of this state.

Password settings

This menu provides a security function that allows an administrator to manage projector use and enable the administrator password function.

Submenu setting	Description
Password	When the password function is enabled, the administrator password is required to access Web Management. Select Disable to allow remote web management of the projector without requiring a password.

 **NOTES**

- The first time you enable the password settings, the default password value is four numbers, for example, 1234.
- If you forget the projector password, refer to *Accessing the service menu* on page 41 to set the projector setting to factory defaults.

Simple Network Management Protocol (SNMP)

Your projector supports a list of SNMP commands as described in the management information base (MIB) file. You can download this file by browsing to smarttech.com/software and clicking the MIB file's link in the *Hardware* section for the projector.

The SNMP agent in your projector supports SNMP version 1 or 2. Upload the MIB file to your SNMP management system application, and then use it as described in your application's user guide.

Crestron® RoomView®

Crestron RoomView Express management software is embedded in the SMART UX80 projector to deliver built-in direct connectivity and control via the IT network. There are no control processors or custom programming is required; just connect the SMART UX80 projector to your network and Crestron RoomView immediately recognizes the device for seamless communication and control.

RoomView Connected® devices also feature built-in instant help-desk messaging and emergency broadcasting to provide the safest, most secure classroom environment so teachers have the confidence to focus on teaching.

Appendix B

Remotely managing your system through an RS-232 serial interface

Connecting your room control system to the SMART UX80 projector	54
Pin configuration on the projector's RS-232 connector	54
Serial interface settings	54
Projector programming commands	56
Projector power state controls	56
Power state controls	58
Display controls	59
Audio controls	60
System controls	61
Service and support controls	63
Network controls	65
Advanced display controls	67
Adjusting projector settings	68

This appendix includes detailed instructions on how to set up your computer or room control system to remotely manage your SMART Board interactive whiteboard system settings through an RS-232 serial interface.

Connecting your room control system to the SMART UX80 projector

By connecting a computer or room control system to the RS-232 serial interface of the SMART UX80 projector, you can select video inputs, start up or shut down your interactive whiteboard system and request information such as projector lamp use, current settings and network addresses.

Pin configuration on the projector's RS-232 connector

The following table provides the pin configuration on the SMART UX80 projector. This pin configuration follows a three-wire connection so that a straight-through male-to-female RS-232 serial cable connects to the projector's serial interface in the following arrangement:

Pin number	Projector's female RS-232 connector
2	Receive data (Rx)
3	Transmit data (Tx)
5	Signal Ground (GND)

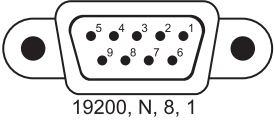

19200, N, 8, 1

Serial interface settings

To be able to make use of the projector's control port, your computer equipment or room control system must be configured to match these serial data communications settings.

Setting	Value
Data Rate	19.2 kbps
Data Bits	8
Parity	None
Stop Bits	1
Flow Control	None

NOTES

- Asynchronous mode is disabled by default in the projector.
- All commands should be in ASCII format. Terminate all commands with a carriage return.

- All responses from the projector are terminated with a command prompt. Wait until you receive the command prompt indicating that the system is ready for another command before you continue.
- The room control feature of the projector is always on.

To configure your computer's serial interface

1. Turn on your computer, and then start your serial communications program or terminal emulation program.
2. Connect your computer to the serial connection cable connected to the projector.
3. Configure your serial interface settings using the values in the previous table, and then press ENTER.

The > character appears as a command prompt.



NOTE

If no message appears or an error message appears, your serial interface configuration isn't correct. Repeat step 3.

4. Type commands to configure your settings.



NOTES

- To see a list of commands available in the current operating mode, type ? and then press ENTER.
- If you're using a terminal emulation program, turn on your program's local echo setting to see characters as you type them.

Projector programming commands

This section documents the projector programming commands and responses.

Projector power state controls

Your projector responds to commands only at certain power states and times.

There are six projector power states.

Command	Control basics
?	Commands the projector to output a list of commands that are available in the projector's current operating mode. Note that some available commands might not appear in the resulting list.
on	Commands the projector to exit Standby mode, to ignite the lamp and to begin projecting an image.
off	Commands the projector to stop projecting an image, to cool down the lamp and to enter Standby mode. The projector doesn't do this immediately; instead, it responds with a request for confirmation, which must be followed by a second "off" command within 10 seconds.
off now	Commands the projector to immediately stop projecting an image, to cool down the lamp and to enter Standby mode without requiring any further confirmation.
get [parameter]	Commands the projector to allow you to retrieve information from the projector about the current state of one of the projector's operating parameters.
set [parameter] = [value]	Commands the projector to allow you to change the current state of one of the projector's operating parameters. For numeric values, the "set" command can also use a plus (+) or a minus (-) operator, in addition to an equals (=) operator.  NOTES <ul style="list-style-type: none">• Attempts to set a parameter to an invalid value return an "invalid command" response.• For parameters that use numeric values, attempts to set the value outside of its operating range result in setting the parameter to its maximum or minimum value.



NOTES

- If you send the projector an invalid command, you receive an “invalidcmd=[the command sent]” message from the projector.
- Projector operating parameters that are accessible via the “set” or “get” commands are listed in the following sections.

Power state controls

These commands put the projector in and out of Standby mode and request the projector's current power state. The projector's power state determines whether certain commands are available at that time. These settings are available even when the projector is in Standby mode.

Usable command by power state		Property	Valid values	Notes
Standby / idle	On			
get	get	powerstate	<ul style="list-style-type: none"> • on • off • confirm off • powering • cooling • idle 	These states may be reported asynchronously, preceded by a # character, if the projector's "staterreporting" function is enabled.
set or get	set or get	staterreporting	<ul style="list-style-type: none"> • on • off (default) 	Causes the projector power state to be reported asynchronously, without a need to get it first.

Display controls

These commands control the video display of the projector.

Usable command by power state		Property	Valid values	Notes
Standby / idle	On			
get	get	videoinputs	Returns a text list of available video source inputs, such as VGA#, HDMI#, Composite.	The default SMART UX80 projector with no accessories will return a list of VGA1, HDMI1, HDMI2.
get	set or get	input	<ul style="list-style-type: none"> • VGA# [# range of 1~5] • HDMI# [# range of 1~5] • Composite • None • Next (settable only, not gettable) 	A default SMART UX80 projector with no additional accessories has VGA1, HDMI1 and HDMI2 only.
	set or get	autosignal	<ul style="list-style-type: none"> • on • off (default) 	Causes the projector to automatically rotate through all available video inputs until a valid video source signal is found.
	set or get	signaldetected	<ul style="list-style-type: none"> • true • false 	Indicates if an active source video signal is detected by the projector.
	set or get	displayhide	<ul style="list-style-type: none"> • normal (default) • frozen • muted 	
	set or get	videomute	<ul style="list-style-type: none"> • on • off (default) 	
	set or get	videofreeze	<ul style="list-style-type: none"> • on • off (default) 	
	set or get	autopoweroff	<ul style="list-style-type: none"> • on • off (default) 	

Audio controls

These commands control the audio of the projector.

Usable command by power state		Property	Valid values	Notes
Standby / idle	On			
	set or get	volumecontrol	<ul style="list-style-type: none"> • on • off (default) 	When off, prevents a user from changing the projector amplifier volume via the remote control or any attached control panel.
	set or get	volume	Numeric value. Range: -20~20 (default = 0)	This may be displayed to the user as a range of 0~40 in the projector's on-screen display.
	set or get	mute	<ul style="list-style-type: none"> • on • off (default) 	
	set or get	sysoutputsw	<ul style="list-style-type: none"> • line • spkr • line+spkr (default) 	Chooses where to route the audio output signal to the internal speaker, to the external audio system (via the line out connector) or both.

System controls

These commands control the integration properties of the projector.

Usable command by power state		Property	Valid values	Notes
Standby / idle	On			
set or get	set or get	usb1source	<ul style="list-style-type: none"> VGA# [# range of 1~5] HDMI# [# range of 1~5] (default = vga1) 	A default SMART UX80 projector with no additional accessories has VGA1, HDMI1 and HDMI2 only.
set or get	set or get	usb2source	<ul style="list-style-type: none"> VGA# [# range of 1~5] HDMI# [# range of 1~5] (default = hdmi1) 	A default SMART UX80 projector with no additional accessories has VGA1, HDMI1 and HDMI2 only.
	set or get	emergencyalertmsg	[text string] (41 character maximum)	Contains text to be displayed when the “emergencyalert” function is turned on.
	set or get	emergencyalert	<ul style="list-style-type: none"> on off (default) 	This will cause the “emergencyalertmsg” to be displayed on the projector instead of the normal image.
	set or get	language	Arabic, Czech, German, Danish, Greek, English (default), Spanish, Finnish, French, Korean, Norwegian, Swedish, Italian, Japanese, Simplified Chinese, Polish, Traditional Chinese, Dutch, Iberian, Portuguese, Russian	<ul style="list-style-type: none"> Matches the languages listed in the projector on-screen display’s <i>language</i> menu. Languages with spaces in the name must be entered without the spaces.
	set or get	lampreminder	<ul style="list-style-type: none"> on off (default) 	Provides a reminder when it’s time to change the projector lamp.

Usable command by power state		Property	Valid values	Notes
Standby / idle	On			
	set or get	startupscreen	<ul style="list-style-type: none">• smart (default)• usercapture• preview	Chooses what splash screen to display at projector startup or when there is no active video source signal.

Service and support controls

These commands control the integration properties of the projector.

Usable command by power state		Property	Valid values	Notes
Standby / idle	On			
	get	modelnum	[model name text string]	The projector's model.
	get	prjserialnum	B01#??##?#### (13-digits, # is any number, ? is any letter)	The projector's serial number.
get	get	fwverddp	###.##	Firmware version for the projector's digital display processor.
get	get	fwvermpu	###.##	Firmware version for the projector's microprocessor unit.
get	get	fwvernet	###.##	Firmware version for the projector's network module. If the network module is disabled, this will report as 0.0.0.0.
get	get	fwverecp	###.##	Firmware version for the attached ECP (extended control panel). If no ECP is attached to the projector, this will be 0.0.0.0.
set or get	set or get	lamphrs	0~5000	Current record of the age of the projector lamp in usage hours.
get	get	syshrs	0~20000	Current record of the age of the projector in usage hours.
	get	displayhour	0~20000	Current record of the age of the projector in usage hours.

REMOTEY MANAGING YOUR SYSTEM THROUGH AN RS-232 SERIAL INTERFACE

Usable command by power state		Property	Valid values	Notes
Standby / idle	On			
	get	resolution	last known video input resolution in the format of ###x###@##Hz or ##i/p	
	set or get	highspeedfan	<ul style="list-style-type: none"> • high • normal (default) 	Enables the high speed fan in hot environments to prevent overheating.
get	get	failurelog	Returns a text list of failures detected by the projector and logged in the projector's failure log (or an indication of "normal"). This is in the format of failure1, failure2, failure3, etc.	Failures detectable by the projector include the following: overtemp, fanlock, fanDMD, fanblower, fansystem, lamperror, colorwheelbreak, lampignite, lampoverheat, lampdriver, lampoverhours
get	gett	error#	Returns text information about the specified error number in the projector's error log.	Reported data: Error type, lamp hours, system hours, system temperature, and lamp voltage when the error was detected.
set	set	restoredefaults		This immediately reset the projector operating parameters to their factory default settings. A hard power-cycle may be required to complete.
set	set	factoryreset	<ul style="list-style-type: none"> • true • false 	Setting this to "true" resets the projector operating parameters to their factory default settings. A hard power-cycle may be required to complete.

Network controls

These commands control the integration properties of the projector.

Usable command by power state		Property	Valid values	Notes
Standby / idle	On			
	set or get	network	<ul style="list-style-type: none"> • on • off (default) 	Enables or disables the network module.
set or get	set or get	vgaoutnetenable	<ul style="list-style-type: none"> • on • off (default) 	Same function as the “network” property.
get	get	netstatus	<ul style="list-style-type: none"> • connected • disconnected • disabled 	Reports if the network port on the projector is or isn’t connected to a network.
set or get	set or get	dhcp	<ul style="list-style-type: none"> • on • off (default) 	When off, the projector’s network IP address, subnetmask, gateway and primary DNS values must all be set manually.
set or get	set or get	ipaddr	A valid IPv4 address in values between 0.0.0.0 and 255.255.255.255	An IPv4 address.
set or get	set or get	subnetmask	A valid IPv4 address in values between 0.0.0.0 and 255.255.255.255	An IPv4 address.
set or get	set or get	gateway	A valid IPv4 address in values between 0.0.0.0 and 255.255.255.255	An IPv4 address.
set or get	set or get	primarydns	A valid IPv4 address in values between 0.0.0.0 and 255.255.255.255	An IPv4 address.
get	set or get	macaddr	xx-xx-xx-xx-xx-xx]	The media access control (MAC) identifier of the projector’s network module.

REMOTEY MANAGING YOUR SYSTEM THROUGH AN RS-232 SERIAL INTERFACE

Usable command by power state		Property	Valid values	Notes
Standby / idle	On			
	set or get	groupname	[text string]	These properties aren't used by any of the projector functions. They exist only for human reference, if desired.
	set or get	projectorname	[text string]	
	set or get	locationinfo	[text string]	
	set or get	contactinfo	[text string]	
	set or get	projectorid	Numeric value between 0 and 99	

Advanced display controls

These commands control the integration properties of the projector.

Usable command by power state		Property	Valid values	Notes
Standby / idle	On			
	set or get	projectionmode	<ul style="list-style-type: none"> • front • ceiling (default) • rear • rear ceiling 	
	set or get	displaymode	<ul style="list-style-type: none"> • SMARTPresentation (default) • Brightroom • Darkroom • sRGB • User 	
	set or get	highbrightness	<ul style="list-style-type: none"> • on (default) • off 	
	get	nativeaspectratio	<ul style="list-style-type: none"> • 16:9 • 16:10 	<ul style="list-style-type: none"> • UX80 reports 16:10 • UX80HD reports 16:9
	set or get	aspectratio	<ul style="list-style-type: none"> • fill (default) • match • 16:9 	
	set or get	brightness	Numeric value. Range: 0~100	Default=50
	set or get	contrast	Numeric value. Range: 0~100	Default=50
	set or get	frequency	Numeric value. Range: -5~5	Automatically detected from current video source.
	set or get	tracking	Numeric value. Range: 0~31	Automatically detected from current video source.
	set or get	hposition	Numeric value. Range: 0~100	Automatically detected from current video source.

Usable command by power state		Property	Valid values	Notes
Standby / idle	On			
	set or get	vposition	Numeric value. Range: -5~5	Automatically detected from current video source.
	set or get	whitepeaking	Numeric value. Range: 0~10	Default=10
	set or get	degamma	Numeric value. Range: 0~3	Default=2
	set or get	red	Numeric value. Range: 0~100	Default=100
	set or get	green	Numeric value. Range: 0~100	Default=100
	set or get	blue	Numeric value. Range: 0~100	Default=100
	set or get	cyan	Numeric value. Range: 0~100	Default=100
	set or get	magenta	Numeric value. Range: 0~100	Default=100
	set or get	yellow	Numeric value. Range: 0~100	Default=100
	set or get	zoom	Numeric value. Range: 0~30	Default=0

Adjusting projector settings



The remote control's Menu button enables you to access the on-screen display to adjust the projector settings.



IMPORTANT

Keep your remote control in a safe place because there is no other way to access menu options.

Setting	Use	Notes
 Image Adjustment menu		
Display Mode	Indicates the projector's display output (SMART Presentation, Bright Room, Dark Room, sRGB and User).	The default is SMART Presentation .
Brightness	Adjusts projector brightness from 0 to 100.	The default is 50.
Contrast	Adjusts the difference between the lightest and darkest parts of the image from 0 to 100.	The default is 50.
Frequency	Adjusts the display data frequency of the projected image from -5 to 5 to match the frequency of your computer's graphics card.	The default is 0. This setting applies to VGA inputs only.
Tracking	Synchronizes your projector's display timing with your computer's graphics card from 0 to 63.	This setting applies to VGA inputs only.
H-Position	Moves the horizontal position of the source video left or right from 0 to 100 (relative to the projected image).	Don't adjust this setting unless you're advised to by SMART Support. Apply this setting only after you make all boom adjustments. This setting applies to VGA inputs only and is useful in situations where the source video is cut off.
V-Position	Moves the vertical position of the source video up or down from -5 to 5 (relative to the projected image).	Don't adjust this setting unless you're advised to by SMART Support. Apply this setting only after you make all boom adjustments. This setting applies to VGA inputs only and is useful in situations where the source video is cut off.
White Peaking	Adjusts the image color brightness from 0 to 10 while providing more vibrant white shades.	A value closer to 0 creates a natural image and a value closer to 10 enhances brightness. The default is 10.



Setting	Use	Notes
Degamma	Adjusts the color performance of the display from 1 to 3.	The default is 2.
Color	Adjusts the Red, Green, Blue, Cyan, Magenta and Yellow colors on the projector from 0 to 100 to provide custom color and luminance output.	Each color has a default value of 100. Adjustments to the color settings register under the User mode.
 Audio menu		
Volume	Adjusts the projector's volume amplification from -20 to 20.	The default is 0.
Mute	Mutes the projector's audio output.	The default is off. If you mute the projector's audio output and then increase or decrease the volume, the volume is restored automatically. You can prevent this from happening by disabling the volume control.
Disable Volume Control	Disables the projector's volume control.	
System Output	Selects one or more speakers or other audio device.	Select Line Out+Speaker, Line Out Only or Speaker Only .
 Projector Functions menu		
3D On/Off	Turns the DLP Link technology 3D feature on or off.	The default is off.
3D Format	Displays the current 3D format (Interleaved or Under-over).	Interleaved breaks down the image frame for each eye, alternately displaying a line of visual information from each frame. Under-over concurrently displays horizontally stretched image frames for each eye, one above the other.
3D Invert Left-Right	Selects the 3D Invert setting (L-R or R-L).	L-R displays visual data for the left eye first. R-L displays visual data for the right eye first.
Auto Signal Detect	Enables or disables signal searching of input connectors.	The default is off. Select On to have the projector continuously switch inputs until it finds an active video source. Select Off to maintain signal detection in one input.

Setting	Use	Notes
Lamp Reminder	Turns the lamp replacement reminder on or off.	This reminder appears 100 hours before the recommended lamp replacement.
Lamp Mode	Adjusts lamp brightness to Standard or Economy .	Standard displays a high-quality, bright image. Economy increases the lamp life by decreasing the brightness of the image.
Auto Power Off (minutes)	Sets the length of the auto power-off countdown timer between 1 and 240 minutes.	The default is 120 minutes. The timer begins to count down when the projector no longer receives a video signal. The timer finishes when the projector enters Standby mode. Select 0 to turn off the timer.
Zoom	Adjusts the zoom to the center of the image in or out from 0 to 30.	The default is 0. Zooming in cuts off the outer edges of the source video.
Projector ID	Displays the projector's unique ID number (from 0 to 99) within your organization's network.	You can refer to or change this number when using the network remote management feature (see <i>Remotely managing your system through a network interface</i> on page 43).
Aspect Ratio	Adjusts the image output to Fill Screen , Match Input or 16:9 .	The default is Fill Screen . Fill Screen produces an image that fills the entire screen by stretching and scaling the source video to match the projector's native resolution and aspect ratio. Match Input displays the source video in its native resolution and aspect ratio. As a result, unused space could appear along the top and bottom edges of the screen (letterbox format) or along the left and right edges of the screen (pillarbox format). See <i>Video format</i> on page 77 for descriptions of each mode.

Setting	Use	Notes
Startup Screen	Selects the type of startup screen (SMART , Capture User Startup Screen , Preview Startup Screen), or Image Alignment Screen.	This screen displays when the projector lamp is starting and a video source signal isn't displayed. SMART displays the default SMART logo on a blue background. Capture User Startup Screen closes the on-screen display menu and captures the entire projected image. The captured image is displayed the next time the on-screen display opens. (The capture can take up to one minute, depending on the complexity of the background graphic.) Preview Startup Screen enables you to preview the default or captured startup screen. Image Alignment Screen enables you to adjust the projected image size, shape and location.
Image Alignment Screen	Enables you to adjust the projected image size, shape and location.	The image alignment screen appears the first time you start your projector. However, you can access it from the startup screen menu any time. Press Menu or Enter to close it.
Set to Default?	Resets projector settings to their default values.	If you select Yes , all projector settings reset to their defaults, reversing any menu changes you made. This action is irreversible. Don't adjust this setting unless you want to reset all of the applied settings, or unless you're advised to by a SMART Support specialist.
USB Source Select	Opens a sub-menu that enables you to select the video input on your projector and the USB receptacle on the ECP.	The defaults are: <ul style="list-style-type: none"> • HDMI-1, USB 1 • HDMI-2, Disabled (no associated USB input) • VGA-1, USB 2
 Network menu		
Network	Activates the projector's RJ45 connector and network features.	

REMOTELY MANAGING YOUR SYSTEM THROUGH AN RS-232 SERIAL INTERFACE

Setting	Use	Notes
Status	Displays the current network status (Connected , Disconnected or Off).	The default is off.
DHCP	Displays the status of the network's Dynamic Host Configuration Protocol (DHCP) as On or Off .	The default is on. On enables a DHCP server on the network to automatically assign an IP address to the projector. Off enables an administrator to assign an IP address manually.
Password Reminder	E-mails the network password to the predefined e-mail recipient.	See <i>Web page management</i> on page 43 to set up a destination e-mail address.
IP Address	Displays the projector's current IP address in values between 0.0.0.0 and 255.255.255.255.	To change the projector's IP address, use the RS-232 connector or use a DHCP server to assign a dynamic IP address, and then set a static IP address using the network remote management feature (see <i>Remotely managing your system through a network interface</i> on page 43).
Subnet Mask	Displays the projector's subnet mask number in values between 0.0.0.0 and 255.255.255.255.	
Gateway	Displays the projector's default network gateway in values between 0.0.0.0 and 255.255.255.255.	
DNS	Displays the projector's primary domain name server (DNS) IP address in values between 0.0.0.0 and 255.255.255.255.	
MAC Address	Displays the projector's MAC address in xx-xx-xx-xx-xx-xx format.	
Group Name	Displays the projector's workgroup name as set by an administrator (maximum 12 characters).	You can set the projector's workgroup name using the remote management features (see <i>Remotely managing your system through a network interface</i> on page 43 and <i>Remotely managing your system through an RS-232 serial interface</i> on page 53).

Setting	Use	Notes
Projector Name	Displays the projector's name as set by an administrator (maximum 12 characters).	You can set the projector's name using the remote management features (see <i>Remotely managing your system through a network interface</i> on page 43 and <i>Remotely managing your system through an RS-232 serial interface</i> on page 53).
Location	Displays the projector's location as set by an administrator (maximum 16 characters).	You can set the projector's location using the remote management features (see <i>Remotely managing your system through a network interface</i> on page 43 and <i>Remotely managing your system through an RS-232 serial interface</i> on page 53).
Contact	Displays the contact name or number for projector support as set by an administrator (maximum 16 characters).	You can set the contact name or number using the remote management features (see <i>Remotely managing your system through a network interface</i> on page 43 and <i>Remotely managing your system through an RS-232 serial interface</i> on page 53).
 Language menu		
Language	Selects language preference.	Projector menu support is available in English (default), Chinese (Simplified), Chinese (Traditional), Czech, Danish, Dutch, Finnish, French, German, Greek, Italian, Japanese, Korean, Norwegian, Polish, Portuguese (Brazil), Portuguese (Portugal), Russian, Spanish and Swedish.
 Information menu		
Lamp Hours	Displays the current number of lamp usage hours from 0 to 4000 hours from when it was last reset.	Always reset the lamp hours after you replace a lamp, because lamp service reminders are based on the current hours of use. See <i>Resetting the lamp hours</i> on page 27 for details on the lamp hours reset procedure.
Input	Displays the currently displayed video input source (VGA, HDMI1, HDMI2 or None).	
Resolution	Displays the projector's most recently detected video source signal resolution and refresh rate.	If there is no current video input source signal, this setting displays the last known source signal image resolution and refresh rate.

REMOTEY MANAGING YOUR SYSTEM THROUGH AN RS-232 SERIAL INTERFACE

Setting	Use	Notes
Firmware Version	Displays the projector's digital display processor (DDP) firmware version in x.x.x.x format.	
MPU Version	Displays the projector microprocessor unit (MPU) firmware version in x.x.x.x format.	
Network Version	Displays the projector's network communications processor firmware version in x.x.x.x format.	If you haven't enabled the Network and VGA Out setting, this setting is unable to display the projector's network communications processor firmware version and displays 0.0.0.0 instead.
Model Number	Displays the projector's model number.	
Serial Number	Displays the projector's serial number.	
UCP ports 1 / 2	Reserved for future application.	

Appendix C

Integrating other devices

Video format	77
Native video format	77
Video format compatibility	78
HD and SD signal format compatibility	79
Video system signal compatibility	80
Connecting peripheral sources and outputs	80

This appendix provides information on integrating your SMART Board interactive whiteboard system with peripheral devices.

Video format

Your projector has a native video format and various video format compatibility modes. You can change image appearances for certain formats and compatibilities.

Native video format

The following table lists the native VESA RGB video format and digital HDMI video format for the projector.

Resolution	Mode	Aspect ratio	Refresh rate (Hz)	Horizontal frequency (kHz)	Pixel clock (MHz)
1280 × 800	WXGA	16:10	60	48	83.5

Video format compatibility

The following tables list the projector's compatible VESA RGB video formats by resolution, which you can adjust by using the aspect ratio commands described in *Adjusting projector settings* on page 68.

Resolution	Mode	Aspect ratio	Refresh rate (Hz)	"Match Input" appearance
720 × 400	720×400_85	1.8:1	85.039	Pillarbox
640 × 480	VGA 60	4:3	59.94	Pillarbox
640 × 480	VGA 72	4:3	72.809	Pillarbox
640 × 480	VGA 75	4:3	75	Pillarbox
640 × 480	VGA 85	4:3	85.008	Pillarbox
800 × 600	SVGA 56	4:3	56.25	Pillarbox
800 × 600	SVGA 60	4:3	60.317	Pillarbox
800 × 600	SVGA 72	4:3	72.188	Pillarbox
800 × 600	SVGA75	4:3	75	Pillarbox
800 × 600	SVGA 85	4:3	85.061	Pillarbox
832 × 624	MAC 16"	4:3	74.55	Pillarbox
1024 × 768	XGA 60	4:3	60.004	Pillarbox
1024 × 768	XGA 70	4:3	70.069	Pillarbox
1024 × 768	XGA 75	4:3	75.029	Pillarbox
1024 × 768	XGA 85	4:3	84.997	Pillarbox
1024 × 768	MAC 19"	4:3	74.7	Pillarbox
1152 × 864	SXGA175	4:3	75	Pillarbox
1280 × 768	SXGA175	1.67:1	60	Letterbox
1280 × 800	WXGA	16:10	60	Native
1280 × 960	Quad VGA 60	4:3	60	Pillarbox
1280 × 960	Quad VGA 85	4:3	85.002	Pillarbox
1280 × 1024	SXGA3 60	5:4	60.02	Pillarbox
1280 × 1024	SXGA3 75	5:4	75.025	Pillarbox

Resolution	Mode	Aspect ratio	Refresh rate (Hz)	“Match Input” appearance
1280 × 1024	SXGA3 85	5:4	85.024	Pillarbox
1400 × 1050	SXGA+	4:3	59.978	Pillarbox
1600 × 1200	UXGA	4:3	60	Pillarbox
1680 × 1050	WSXGA+	16:10	60	Native
1920 × 1080	HD 1080	16:9	60	Letterbox

HD and SD signal format compatibility

The following tables list the projector’s high definition and standard definition format signal compatibility, which you can adjust by using the aspect ratio commands described in *Adjusting projector settings* on page 68.

Signal format	Aspect ratio	Horizontal frequency (kHz)	Vertical frequency (Hz)	“Match Input” appearance
480i (525i)	4:3	15.73	59.94	Full screen
480p (525p)	4:3	31.47	59.94	Full screen
576i (625i)	5:4	15.63	50	Pillarbox
576p (625p)	5:4	31.25	50	Pillarbox
720p (750p)	16:9	45	59.94	Letterbox
720p (750p)	16:9	37.5	50	Letterbox
1080i (1125i)	16:9	33.75	59.94	Letterbox
1080i (1125i)	16:9	28.13	50	Letterbox
1080p (1125p)	16:9	67.5	59.94	Letterbox
1080p (1125p)	16:9	56.25	50	Letterbox

NOTE

Your projector is HD-ready. Its native resolution supports a pixel-perfect display of 720p source content. However, because the projector compresses 1080p source content to fit its native resolution, it doesn’t support a pixel-perfect display of 1080p source content.

Video system signal compatibility

The following tables list the projector's video system signal compatibility delivered over HDMI video connectors, which you can adjust by using the aspect ratio commands described in *Adjusting projector settings* on page 68.

Video mode	Aspect ratio	Vertical frequency (Hz)
720p	16:9	59.94
720p	16:9	50
1080i	16:9	50
1080p	16:9	50.94
1080p	16:9	50
576i	5:4	50
480i	4:3	50.94

Connecting peripheral sources and outputs

Follow these instructions if you have a peripheral device to connect to your interactive whiteboard system, such as a DVD/Blu-ray player.

NOTE

Measure the distance between the projector and the peripheral device you want to connect. Make sure each cable is long enough, has plenty of slack and can be placed safely in your room without presenting a trip hazard.

To connect a peripheral source or output to your projector

1. Connect your peripheral device's input cables to the projector.
2. Switch input sources to the peripheral device by pressing the **Input** button on the remote control.

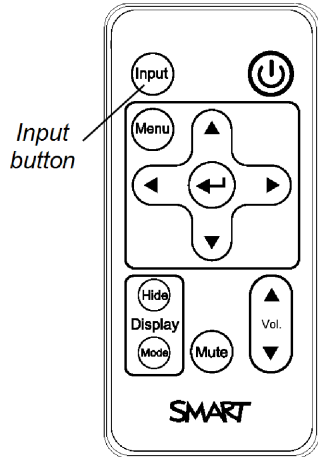

To connect a laptop to a SMART Board interactive whiteboard system

1. Connect a USB cable from the laptop to the appropriate USB port on the back of the pen tray.
2. Connect a VGA cable from the laptop to the projector.

OR

Connect an HDMI cable from the laptop to the projector.

3. Press the **Input** button on the remote control or the **Input Select** button on the pen tray to switch input sources to the laptop.

The SMART UX80 projector allows synchronization between two adjacent systems. The two projectors can be connected with a Cat 5 crossover cable to allow the control of the power states through a single interactive whiteboard, through the remote control or through a room control system.

To connect a second projector

Connect a Cat 5 crossover cable to the Projector 2 port of the primary SMART UX80 projector and into the Projector 2 port of the secondary SMART UX80 projector.



NOTE

The Projector 2 ports synchronize power states only and don't carry audio or video.

Appendix D

Remote control code definitions

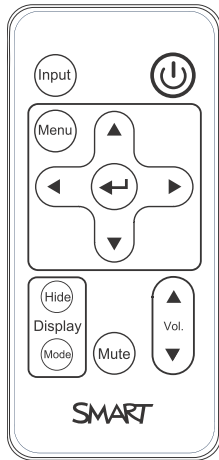

IR signal format: NEC1

Key	Repeat format	Vendor code		Key code	
		Byte 1	Byte 2	Byte 3	Byte 4
Input	F1	8B	CA	14	EB
Power (⏻)	F1	8B	CA	12	ED
Menu	F1	8B	CA	1B	E4
Up (▲)	F1	8B	CA	40	BF
Left (◀)	F1	8B	CA	42	BD
Enter (↵)	F1	8B	CA	13	EC
Right (▶)	F1	8B	CA	43	BC
Down (▼)	F1	8B	CA	41	BE
Hide	F1	8B	CA	15	EA
Volume up (▲)	F1	8B	CA	44	BB
Mode	F1	8B	CA	45	BA
Mute	F1	8B	CA	11	EE
Volume down (▼)	F1	8B	CA	46	B9

Appendix E

Hardware environmental compliance

SMART Technologies supports global efforts to ensure that electronic equipment is manufactured, sold and disposed of in a safe and environmentally friendly manner.

Waste Electrical and Electronic Equipment and Battery regulations (WEEE and Battery Directives)

Electrical and electronic equipment and batteries contain substances that can be harmful to the environment and to human health. The crossed-out wheeled bin symbol indicates that products should be disposed of in the appropriate recycling stream and not as regular waste.



Batteries

Remote contains CR2025 battery. Recycle or dispose of batteries properly.

Perchlorate material

Contains perchlorate material. Special handling may apply. See dtsc.ca.gov/hazardouswaste/perchlorate.

Mercury

The lamp in this product contains mercury and must be recycled or disposed in accordance with local, state, provincial and federal laws.



More information

See smarttech.com/compliance for more information.

Index

3

3.5 mm audio connectors 11

A

accessories

included 5

optional 5

alarms 47

aspect ratios 3, 18, 46, 71, 77-80

audio 60

controlling volume of 45

muting 14

resolving issues with 39

B

batteries 28, 85

Blu-ray players 80

C

cameras 80

closed captioning 45

connection diagrams

projector 11

contact person 49

D

DHCP 19, 48, 73

display modes 14-15, 45, 69

DNS 48

document cameras 80-81

dust iv

DVD players 80

E

e-mail alerts 49

electrostatic discharge iv

emergency alerts 47

emissions iv

environmental requirements iv

F

fans 34, 47

flickering 37

focus 10

H

HD signal compatibility 79

HDMI connections 12, 47

head space clearance 8

height 8

humidity iv

I

image

adjusting 10

focusing 10

resolving issues with 36

image alignment screen 10

input selection 47

installation

choosing a height 8

choosing a location 7

INDEX

interactive whiteboard
 about 2
 indicators and controls of 33
 maintaining 23
 using 22
IP address 19, 44, 48, 73

L

lamp module
 cleaning 25
 resolving issues with 35
laptop computers
 connecting 81
 troubleshooting issues with 38
letterboxing 78-79
light sources 7
location 7, 49

M

MAC support 78
mercury 85
mounting template 8
mute control 14, 16, 45, 70

N

native video formats 77
network communication 12, 40, 48

O

options 5
original packaging 42

P

passwords 19, 41, 50, 73
pens 5
Perchlorate material 85
peripheral sources 80

pillarboxing 78-79
power 12, 45, 56, 58-59, 61, 63, 65, 67
projector
 about 3
 adjusting settings for 15, 68
 adjusting the image of 10
 cleaning 25
 connection diagram for 11
 displaying the name of 49
 focusing the image of 10
 installing 7
 lights and status of 30
 locating the serial number on 31
 remotely managing 43, 53
 routing cables from 9, 12
 troubleshooting 34
 using your remote control with 13
 video format compatibility for 77

Q

quad VGA support 78

R

refresh rates 77-78
remote control
 about 5
 code definitions for 83
 installing the battery 28
 using the buttons 14
RJ45 connector 12
room control 43, 53
RS-232 serial interface 11, 54

S

SD signal compatibility 79
serial interface See RS-232 serial interface
serial number 31
signal loss 36

INDEX

SMART Board interactive
 whiteboard See interactive
 whiteboard
SMART UX80 projector See projector
SMTP 50
SNMP 49, 51
sound See audio
startup screen 47
subnet mask 19, 48, 73
SVGA support 78
SXGA support 78

T

temperatures, operating and storage iv
transportation 42
TRAP destination address 49
troubleshooting 29

U

USB receptacles 12
UX80 projector See projector
UXGA support 78

V

VGA connections 47
VGA support 78
video
 format compatibility for 77

W

warnings iii
water and fluid resistance iv
web page management 43
WEEE and Battery Directives 85
whiteboard See interactive whiteboard

X

XGA support 78

Z

zoom 46

SMART TECHNOLOGIES

smarttech.com/support

smarttech.com/contactsupport

smarttech.com/kb/170548