

SMART kapp

USER'S GUIDE
FOR MODEL KAPP42

Product registration

If you register your SMART product, we'll notify you of new features and software upgrades.

Register online at smarttech.com/registration.

Keep the following information available in case you need to contact SMART Support.

Serial number:

Date of purchase:

Trademark notice

DViT, kapp, smarttech, the SMART logo and all SMART taglines are trademarks or registered trademarks of SMART Technologies ULC in the U.S. and/or other countries. Apple, App Store, iPhone and iPad are trademarks of Apple Inc., registered in the U.S. and other countries. Android and Google Play are trademarks of Google Inc. The Android robot is reproduced or modified from work created and shared by Google and used according to terms described in the Creative Commons 3.0 Attribution License. The Bluetooth word mark is owned by the Bluetooth SIG, Inc. and any use of such marks by SMART Technologies ULC is under license. All other third-party product and company names may be trademarks of their respective owners.

Copyright notice

© 2014 SMART Technologies ULC. All rights reserved. No part of this publication may be reproduced, transmitted, transcribed, stored in a retrieval system or translated into any language in any form by any means without the prior written consent of SMART Technologies ULC. Information in this manual is subject to change without notice and does not represent a commitment on the part of SMART.

This product and/or use thereof covered by one or more of the following U.S. patents.

www.smarttech.com/patents

11/2014

Important information

WARNING

- Your SMART product includes instructions for installation on metal and wood stud walls and certain masonry wall types only. A SMART hardware kit is available for these types of installation (Part No. 1024563). In the event that you need to install your SMART product on reinforced concrete walls, walls with plaster lath finishing or other types of walls, refer to your local building authority for instructions, recommendations and safe work practices.
- Do not open or disassemble the SMART product. You risk electrical shock from the high voltage inside the casing. Opening the casing also voids your warranty.
- Ensure that any cables extending across the floor to your SMART product are properly bundled and marked to avoid a trip hazard.
- Ensure your installation complies with local building and electrical codes.
- Failure to follow the installation instructions shipped with your SMART product could result in personal injury and product damage which may not be covered by your warranty.
- To reduce the risk of fire or electric shock, do not expose the SMART product to rain or moisture.
- Use SMART supplied mounting hardware or hardware that is designed to properly support the weight of your product.
- Use the power cable provided with this product. If a power cable is not supplied with this product, please contact your supplier. Use only power cables that match the AC voltage of the power outlet and that comply with your country's safety standards.
- Do not place any heavy objects on the power cable. Damage to the cable could cause shock, fire or product damage which may not be covered by your warranty.

Contents

Important information	i
Chapter 1: Welcome	1
About your capture board	1
About this guide	3
Other documentation and resources	3
Chapter 2: Using your capture board	5
Writing on your capture board	6
Connecting your mobile device to your capture board	6
Sharing and saving your notes	11
Chapter 3: Maintaining your capture board	17
Cleaning your capture board	17
Transporting your capture board	18
Replacing the markers and eraser	18
Chapter 4: Troubleshooting your capture board	19
Resolving hardware issues using the indicator lights	19
Resolving app issues	21
Appendix A: Hardware environmental compliance	23
Waste Electrical and Electronic Equipment (WEEE)	23
More information	23

Chapter 1

Welcome

About your capture board	1
Capture board	2
Dry erase markers and eraser	2
Mounting bracket and hardware	2
SMART kapp app	3
About this guide	3
Other documentation and resources	3
Specifications	3
Installation instructions	3
Tutorial and Help	4
Training	4
Frequently asked questions	4
Support center and knowledge base	4

This chapter introduces you to your SMART kapp™ capture board and this guide.

About your capture board

The SMART kapp capture board enables you to collaborate with others in a simple but powerful way. Write and draw on the capture board like you would a regular dry erase board. You can then connect a Bluetooth®-enabled mobile device to the capture board by scanning a Quick Response (QR) code or by tapping the Near Field Communication (NFC) tag. When you first connect your mobile device, you're directed to the Apple App Store or Google Play™ to download the SMART kapp app. After you download and install the app, you can use it to connect to your capture board and share content with others.

The SMART kapp capture board product consists of the following components:

- Capture board
- Dry erase markers and eraser
- Mounting bracket and hardware
- SMART kapp app

Capture board

The capture board features SMART's proprietary DViT® (Digital Vision Touch) technology on a 42" (107 cm) writing surface. DViT technology captures the notes you make on the capture board using the dry erase markers and eraser. The capture board's Bluetooth® 4.0 wireless technology (for Apple mobile devices) or Bluetooth 2.1 + EDR wireless technology (for Android™ mobile devices) then transfers your notes as a digital image to a connected mobile device. Alternatively, you can save your notes to a FAT-formatted USB drive by connecting it to the capture board's USB 2.0 Type-A receptacle. You can also use the capture board's standard 500 mA USB 2.0 Type-A receptacle to charge your smart phone.

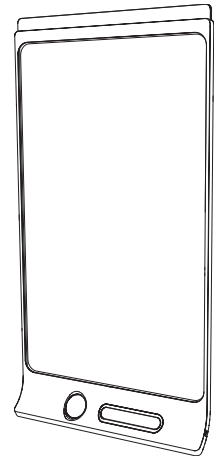

Dry erase markers and eraser

Your capture board comes with three dry erase markers and an eraser that are specially designed to work with the capture board.

The capture board includes holders for one marker and the eraser as well as a storage area (on the back of the capture board) for the other two markers.

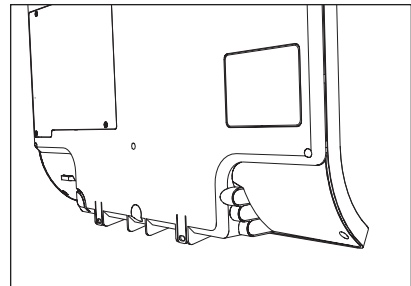
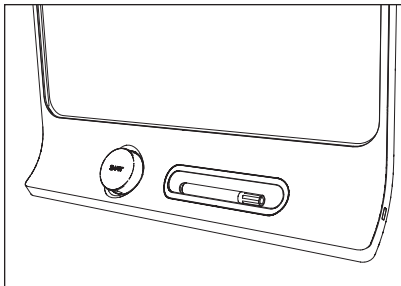

Use the markers to write or draw, and use the eraser to erase.

Mounting bracket and hardware

You can mount your capture board on a wall using the supplied mounting bracket and hardware. Alternatively, you can mount the capture board using a standard VESA® 400 mm × 400 mm mounting bracket.

SMART kapp app

The SMART kapp app enables you to connect your Apple or Android mobile device to your capture board and then do the following:

- View notes you write on your capture board on your mobile device
- Share your notes with others
- Save your notes

About this guide

This guide explains how to use your capture board. It includes the following information:

- How to use your capture board and the SMART kapp app
- How to maintain your capture board for years of use
- How to troubleshoot issues with your capture board

This guide is intended for individuals who use and maintain capture boards. Other documentation and resources are available for individuals who install capture boards.

Other documentation and resources

SMART provides an extensive library of documentation and resources for your capture board.

Specifications

The *SMART kapp 42" capture board specifications* (smarttech.com/kb/170770) define the capture board's dimensions, weight, recommended operating and storage temperatures, power specifications and other important information.

Installation instructions

Your capture board comes with installation instructions that explain how to mount the capture board using the supplied mounting bracket and hardware.

If you misplaced the installation instructions, you can download them from smarttech.com/kb/170768.

Tutorial and Help

When you first start the SMART kapp app on your mobile device, a tutorial opens. This tutorial explains how to connect your mobile device to your capture board and share and save your notes (see *Installing the app and starting it for the first time* on page 8).

If you want to view the tutorial subsequent times, you can open it by pressing **Settings**  on the app home screen and then pressing **Tutorial**. You can also view troubleshooting and support information in the Help.

Training

The SMART training website (smarttech.com/trainingforbusiness) includes an extensive library of training resources you can refer to when learning how to use your capture board.

Frequently asked questions

For answers to common questions about the capture board, see *SMART kapp capture board frequently asked questions* (smarttech.com/kb/170793).

Support center and knowledge base



The Support center (smarttech.com/support) includes documentation and a knowledge base that you can refer to when performing maintenance on your capture board or troubleshooting issues with your capture board.

Chapter 2

Using your capture board

Writing on your capture board	6
Connecting your mobile device to your capture board	6
About QR codes and NFC	7
Installing the app and starting it for the first time	8
Connecting your mobile device using the app	9
Viewing notes on your mobile device	10
Disconnecting your mobile device	10
Sharing and saving your notes	11
Sharing your notes	11
Saving snapshots of your notes using the app	12
Saving snapshots	12
Viewing and changing the order of snapshots	13
Exporting snapshots	14
Deleting snapshots	15
Saving snapshots of your notes to a USB drive	16

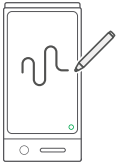
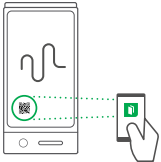
This chapter explains how to use your capture board. Using your capture board involves three high-level steps:

Step	Description	Reference
	Writing on your capture board	Page 6
	Connecting your mobile device to your capture board	Page 6
	Sharing and saving your notes	Page 11

Writing on your capture board

You can write and erase notes on your capture board like you do on a traditional dry erase board.

- Use the markers provided with your capture board to write or draw
- Use the eraser provided with your capture board to erase notes.
- Ensure your hands, arms and any loose clothing don't touch your capture board's surface as you write or erase notes.

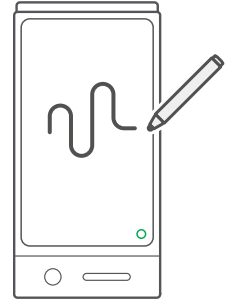

For information on replacing the capture board's markers and eraser, see *Replacing the markers and eraser* on page 18.

Connecting your mobile device to your capture board

Before you can share the notes you have written on your capture board with others, you need to connect your mobile device to the capture board.

You can connect the following types of mobile devices to your capture board:

Device type	Requirements	Connection options
Apple	<ul style="list-style-type: none">• iOS 7.1 or later operating system software• 50 MB of storage• iPhone 4S or later• Third generation iPad or later• First generation iPad mini or later• Fifth generation iPod touch or later	Scan the capture board's unique QR code

Device type	Requirements	Connection options
Android	<ul style="list-style-type: none">• Android 4.1 (Jelly Bean) or later operating system• 50 MB of storage (internal or SD card)• 1024 MB of RAM• 720p or better screen resolution• Bluetooth 2.1 + EDR¹• NFC (recommended)• 3 megapixel or better rear-facing camera (recommended)	<ul style="list-style-type: none">• Scan the capture board's unique QR code• Tap the capture board's NFC tag

 **NOTE**

Most of the SMART kapp app's features are identical across iOS operating system software and Android operating systems. However, some features are available for only one of these operating systems. The remainder of the user's guide highlights these features with the following icons:



iOS operating system software



Android operating systems

When you first connect a mobile device, you're prompted to install an app. You can then use the app to share notes you have written on your capture board with others.

About QR codes and NFC

As noted in the previous section, you can connect your mobile device to your capture board by scanning the capture board's QR code or by tapping the capture board's NFC tag.



- A QR code is a type of bar code. If your mobile device has a rear-facing camera and a QR code scanning app, you can scan QR codes like the one on your capture board. Your mobile device then executes the QR codes' commands. Typically, QR codes' commands display messages or open web pages.

¹Compatible with Bluetooth 3.0 and dual-mode Bluetooth 4.0



- NFC is a wireless technology that enables you to connect your mobile device and another device, such as your capture board, by holding your mobile device a short distance from (or “tapping”) the other device.



NOTE

Currently, you are unable to connect the capture board to an iPhone 6 using the mobile device’s NFC support.



TIP

Refer to your mobile device’s documentation for the location of its NFC radio. When connecting your mobile device to the capture board, you might need to move the mobile device back and forth until its NFC radio detects the capture board’s NFC tag.

Installing the app and starting it for the first time

The SMART kapp app enables you to connect your mobile device to your capture board, view notes you write on your capture board on your mobile device and share and save your notes. You can install the app on your mobile device by scanning your capture board’s QR code or by tapping its NFC tag.

To install the app

1. Do one of the following:
 - a. Start the QR code scanning app on your mobile device, and then hold your mobile device’s rear-facing camera over your capture board’s QR code to scan it.
 - b. Enable NFC in your mobile device’s settings (if it isn’t already enabled), and then hold your mobile device near your capture board’s NFC tag .

The Apple App Store or Google Play opens.

2. Download and install the app.

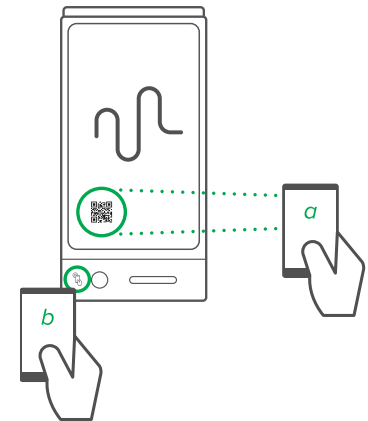

To start the app for the first time

1. Start the SMART kapp app on your mobile device.

The app tutorial appears.

2. Use the swipe gestures to progress through the screens of the tutorial.

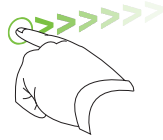

Previous screen

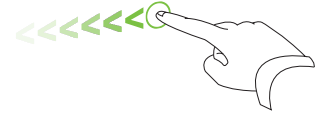

Next screen

3. Press **Done** when you have completed the tutorial.

The app home screen appears.



TIP

If you want to view the tutorial again, press **Settings**  on the app home screen and then press **Tutorial**.

Connecting your mobile device using the app

After you install the SMART kapp app, you can use it to connect your mobile device to your capture board by QR code or by NFC.



To connect your mobile device by QR code

1. Start the SMART kapp app on your mobile device.
2. Hold your mobile device's rear-facing camera still over your capture board's QR code so that the QR code appears in the center of the app screen.

The app connects your mobile device to your capture board.

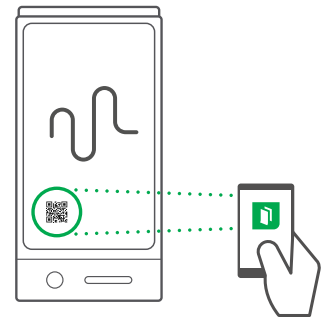

NOTE

If the app doesn't connect your mobile device to your capture board, move your mobile device closer to or further away from the capture board so that the app can capture the QR code.



To connect your mobile device by NFC

1. Enable NFC in your mobile device's settings (if it isn't already enabled).
2. Hold your mobile device near your capture board's NFC tag .

The SMART kapp app starts and connects your mobile device to your capture board.

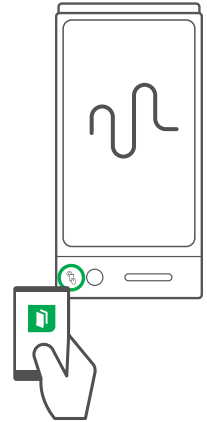

Viewing notes on your mobile device

When your mobile device and capture board are connected, you can view the notes you've written on your capture board on your mobile device. As you write or erase notes, the changes appear on your mobile device automatically.

By default, your mobile device displays your capture board's entire writing surface. You can zoom in, zoom out and pan using gestures:

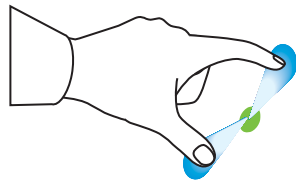

Zoom in

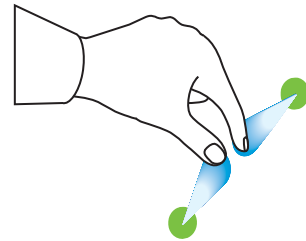

Zoom out

NOTE

As you zoom in or out, grid lines appear on the writing surface to indicate the level of magnification.

Disconnecting your mobile device

Your mobile device disconnects from your capture board automatically in the following situations:

- You close the app.
- The app closes automatically after a period of non-use.

- Your capture board is outside of your mobile device's Bluetooth communication range, which is approximately 33' (10 m).

To manually disconnect your mobile device, hold **Bluetooth**  on your capture board until it turns solid red.



 **NOTE**

When you connect an Android mobile device to your capture board, an icon appears in the notification area. This icon indicates when the mobile device is connected to your capture board:



Connected



Disconnected

Sharing and saving your notes

Unlike a traditional whiteboard, your capture board enables you to share your notes with others and save them for later reference. Specifically, you can do the following:

- Share your notes with others as you write them on your capture board
- Save snapshots of your notes using the app
- Save snapshots of your notes to a USB drive

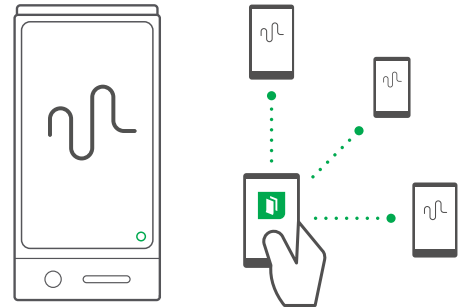

Sharing your notes

After you connect your mobile device to your capture board, you can use the SMART kapp app to invite up to five others to view your notes on their mobile devices or computers. When others receive your invitation to view your notes, they press or click a link to view your notes in their Internet browsers; they don't need to install additional software or otherwise configure their mobile devices or computers.

As you make changes to your notes, others see these changes in real time. They can also zoom in or out, and save, view and export snapshots.

 **NOTE**

You can share your notes only as long as the SMART kapp app is running on your mobile device and your mobile device is connected to your capture board. However, you can export saved snapshots of notes without connecting your mobile device to your capture board (see *Sharing your notes* on the previous page).

 **To share your notes**

1. Connect your mobile device to your capture board (see *Connecting your mobile device using the app* on page 9).
2. Press **Invite** .
3. Select the app you want to use to send the invitation.
4. Use the selected app to send the invitation.

Saving snapshots of your notes using the app

As you write notes on your capture board, you might want to save snapshots on occasion to capture how your notes change during your note-taking session.

After you save snapshots, you can do the following:

- View the snapshots
- Change the order of the snapshots (Apple mobile devices only)
- Export the snapshots as JPEG or PDF files to share with others
- Delete the snapshots

Saving snapshots

 **To save a snapshot**

1. Connect your mobile device to your capture board (see *Connecting your mobile device using the app* on page 9).

2. Press **Capture**  on your capture board.

OR

Press **Capture**  in the app.

The app saves a snapshot of your notes.



NOTE

The *Snapshot Gallery*  button in the bottom-right corner of the screen indicates how many snapshots have been saved in the current session.

Viewing and changing the order of snapshots

To view snapshots in the current session

1. Save one or more snapshots in the current session (see *Saving snapshots* on the previous page).
2. Press **Snapshot Gallery** .

The session's snapshot gallery appears.

3. Press a snapshot's thumbnail image to view it.



TIP

You can use the zoom in, zoom out and pan gestures when viewing the snapshot (see *Viewing notes on your mobile device* on page 10).

To view snapshots in previous sessions

1. If you're currently in a session, press **Close** , and then press **Disconnect**.

The session ends, and the app home screen appears.

2. Press **Snapshot History** .

The *Snapshot History* screen appears.

3. Press a session's row to view the snapshots saved for that session.

The session's snapshot gallery appears.

4. Press a snapshot's thumbnail image to view it.



TIP

You can use the zoom in, zoom out and pan gestures when viewing the snapshot (see *Viewing notes on your mobile device* on page 10).



To change the order of snapshots in the current session

1. Save two or more snapshots in the current session (see *Saving snapshots* on page 12).
2. Press **Snapshot Gallery** .

The session's snapshot gallery appears.
3. Drag a snapshot's thumbnail to change its order.



To change the order of snapshots in previous sessions

1. If you're currently in a session, press **Close** , and then press **Disconnect**.

The session ends, and the app home screen appears.
2. Press **Snapshot History** .

The *Snapshot History* screen appears.
3. Press a session's row to view the snapshots saved for that session.

The session's snapshot gallery appears.
4. Drag a snapshot's thumbnail to change its order.

Exporting snapshots

To export a snapshot

1. View the snapshot you want to export (see *Viewing and changing the order of snapshots* on the previous page).
2. Press **Export** , and then select **Export to JPEG** or **Export to PDF**.
3. Select the app you want to use to export the snapshot.
4. Use the selected app to export the snapshot.

■ To export all snapshots saved in the current session

1. Save one or more snapshots in the current session (see *Saving snapshots* on page 12).
2. Press **Export** , and then select **Export to JPEG** or **Export to PDF**.
3. Select the app you want to use to export the snapshots.
4. Use the selected app to export the snapshots.

■ To export all snapshots saved in a previous session

1. If you're currently in a session, press **Close** , and then press **Disconnect**.

The session ends, and the app home screen appears.

2. Press **Snapshot History** .

The *Snapshot History* screen appears.

3. Press a session's row to view the snapshots saved for that session.

The session's snapshot gallery appears.

4. If you're using an Apple mobile device, press **Export** .

OR

If you're using an Android mobile device, press **Menu** , and then select **Export to PDF**.

5. Select the app you want to use to export the snapshots.
6. Use the selected app to export the snapshots.

Deleting snapshots

■ To delete a snapshot from a previous session

1. If you're currently in a session, press **Close** , and then press **Disconnect**.





The session ends, and the app home screen appears.

2. Press **Snapshot History** .

The *Snapshot History* screen appears.

3. Press the session containing the snapshot you want to delete.
The session's snapshot gallery appears.
4. Press the snapshot you want to delete.
5. Press **Delete** , and then press **OK**.



To delete a previous session of snapshots

1. If you're currently in a session, press **Close** , and then press **Disconnect**.
The session ends, and the app home screen appears.
2. Press **Snapshot History** .
The *Snapshot History* screen appears.
3. If you're using an Apple mobile device, press **Edit**.
OR
If you're using an Android mobile device, press **Menu** , and then select **Select**.
4. Select the session you want to delete.
5. Press **Delete** , and then press **OK**.

Saving snapshots of your notes to a USB drive

If you don't have access to a mobile device or would prefer to save snapshots of your notes using another means, you can save PDF snapshots to a FAT-formatted USB drive.

To save a snapshot

1. Connect the USB drive to the USB 2.0 Type-A receptacle on the side of your capture board.
2. Press **Capture**  or **USB**  on your capture board.
The capture board saves a snapshot of your notes to the USB drive.
3. Disconnect the USB drive from your capture board when you're done saving snapshots.

Chapter 3

Maintaining your capture board

Cleaning your capture board	17
Transporting your capture board	18
Replacing the markers and eraser	18

This chapter explains how to maintain your capture board for years of use.

Cleaning your capture board

With proper care, your capture board will provide years of trouble-free service. Follow these tips to keep the capture board clean:

- Don't spray cleaner directly onto the capture board's writing surface. Instead, spray a light amount of cleaner on a cloth and then gently wipe the writing surface.
- Clean your capture board at least monthly.
- Don't allow excess cleaner to flow onto the bezel's reflective surfaces.
- Remove any dry erase dust from the bezel's reflective surfaces.
- The digital cameras located in the bezel are protected from dust and dirt by windows. In extremely dusty environments, spray a household, alcohol-free glass cleaner, such as Windex® cleaner, on a cotton swab and rub it gently on the windows. Don't use compressed air to clean the cameras, and don't apply too much pressure because doing so could damage the reflective surfaces or the cameras.



IMPORTANT

Disconnect your capture board from power before cleaning it.

Transporting your capture board

Save your original packaging to repack your capture board if needed. This packaging was designed with optimal shock and vibration protection. If your original packaging isn't available, you can purchase the same packaging directly from your authorized SMART reseller.

CAUTION

Transport your capture board only in original or replaced packaging. Transporting your capture board without correct packaging voids your warranty and could lead to product damage.

Replacing the markers and eraser

Your capture board comes with three dry erase markers and one eraser.

If you misplace the markers or if they run dry, you can replace them with third-party dry erase markers. The barrel of third-party dry erase markers can be any length and diameter, but the tip and nib must be within the following dimensions:

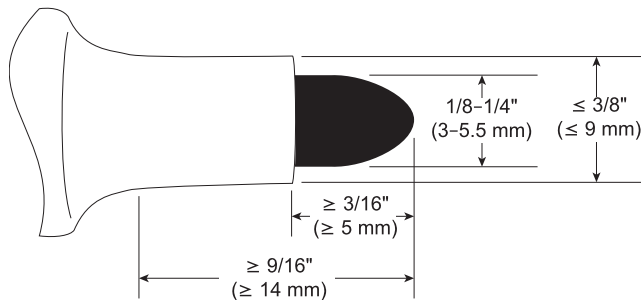

If you misplace the eraser, you can purchase a replacement from the Store for SMART Parts (see smarttech.com/Support/PartsStore).

Chapter 4

Troubleshooting your capture board

Resolving hardware issues using the indicator lights	19
Resolving app issues	21

This chapter explains how to troubleshoot common issues with your capture board and the SMART kapp app.



Resolving hardware issues using the indicator lights

Your capture board includes four indicator lights in the bottom-right corner. When you first connect your capture board to a power source, the indicator lights turn on and off in the following order until the capture board is ready for use:

- Status
- Bluetooth
- USB
- Capture

CHAPTER 4
TROUBLESHOOTING YOUR CAPTURE BOARD

When the capture board is ready for use, you can refer to these indicator lights to identify the status of the capture board and diagnose common issues.

Light	Situation	Troubleshooting (if required)
 Status		
Off	Your capture board isn't receiving power.	<ul style="list-style-type: none"> Ensure the capture board is connected to a power supply and is receiving power. If the Status light is still off, contact SMART Support for assistance.
On	Your capture board is receiving power and is working properly.	
Flashing (after startup)	Your capture board is receiving power but isn't working properly.	<ul style="list-style-type: none"> Write on the capture board using only compatible markers (see <i>Replacing the markers and eraser</i> on page 18). Ensure there are no obstructions (including markers) in the bezel. Clean the writing surface and bezel (see page 17). If the Status light continues to flash, contact SMART Support for assistance.
 Bluetooth		
Off	<ul style="list-style-type: none"> Your capture board isn't connected to a mobile device. Your capture board was previously connected to a mobile device but the SMART kapp app on the mobile device isn't running or your capture board is outside of the mobile device's Bluetooth communication range. 	If you previously connected the mobile device, ensure the SMART kapp app is running and the capture board is within the mobile device's Bluetooth communication range.
Flashing	Your capture board is connecting to a mobile device.	
On	Your capture board is connected to a mobile device.	
Flashing red	Your capture board is disconnecting from the mobile device.	
Solid red	Your capture board has disconnected from the mobile device.	
 USB		
Off	<ul style="list-style-type: none"> Your capture board isn't connected to a USB drive. Your capture board doesn't recognize the connected device as a USB drive. 	Connect only USB drives to the USB receptacle.
Flashing	<ul style="list-style-type: none"> Your capture board is connecting to a USB drive. Your capture board is saving a snapshot of your notes to the connected USB drive. 	

Light	Situation	Troubleshooting (if required)
On	Your capture board is connected to a USB drive.	
Flashing red	Your capture board is unable to save snapshots of your notes to the connected USB drive because the USB drive is full, is not FAT formatted or there's another problem with it.	Disconnect the USB drive, and then connect a different USB drive (see <i>Saving snapshots of your notes to a USB drive</i> on page 16).
 Capture		
Off	Your capture board isn't connected to a USB drive or a mobile device.	
Flashing	Your capture board is saving a snapshot of your notes to the connected mobile device.	
On	Your capture board is connected to a USB drive or a mobile device.	

Resolving app issues

The following are issues that you might encounter while using the SMART kapp app.

Situation	Troubleshooting
You're unable to connect your mobile device to the capture board.	Ensure there are no other mobile devices connected to the capture board. (You can connect only one mobile device to the capture board at a time.)
You're unable to connect your mobile device using the QR code.	<ul style="list-style-type: none"> • Ensure your rear-facing camera is working and Bluetooth is enabled. • Ensure the QR code is clean and fully visible. • Position your mobile device so that your capture board's QR code appears in the center of the SMART kapp app screen.
You're unable to connect your mobile device using NFC.	<ul style="list-style-type: none"> • Ensure your mobile device supports NFC. • Ensure NFC and Bluetooth are enabled in your mobile device's settings. • Position your mobile device as close as possible to the NFC tag on your capture board when connecting.

CHAPTER 4
TROUBLESHOOTING YOUR CAPTURE BOARD

Situation	Troubleshooting
When you write on the capture board, your writing doesn't appear in the SMART kapp app, or extra lines or other visual noise appear in the SMART kapp app.	<ul style="list-style-type: none">• Ensure the capture board's cameras and bezel are clean (see <i>Cleaning your capture board</i> on page 17).• Ensure your hands, arms or loose clothing aren't coming in contact with the capture board as you write.• Write on the capture board using only compatible markers (see <i>Replacing the markers and eraser</i> on page 18).• Keep your capture board away from bright light sources such as direct sunlight and incandescent lighting.
There's another issue not documented in this guide.	Contact SMART Support for assistance.

Appendix A

Hardware environmental compliance

SMART Technologies supports global efforts to ensure that electronic equipment is manufactured, sold and disposed of in a safe and environmentally friendly manner.

Waste Electrical and Electronic Equipment (WEEE)

Electrical and electronic equipment contain substances that can be harmful to the environment and to human health. The crossed-out wheeled bin symbol indicates that products should be disposed of in the appropriate recycling stream and not as regular waste.



More information

See smarttech.com/compliance for more information.

SMART TECHNOLOGIES

smartkapp.com

smarttech.com/kb/170769